

APEX®

Industrial Fastener Tools



Table of Contents

Introduction	2	5/8" Drive Sockets, Extensions, Adapters & Universal Wrenches	
Bits		SAE Sockets and Universal Wrenches.....	.66
Phillips	7	Metric Sockets.....	.67
Slotted	13	Extensions and Adapters.....	.67
Torx®	16	3/4" Drive Sockets, Extensions, Adapters & Universal Wrenches	
Torx Plus®.....	18	SAE Sockets and Universal Wrenches.....	.68
Pozidriv®.....	19	Metric Sockets.....	.70
Sel-O-Fit®.....	20	Extensions and Adapters.....	.70
Quadrex®.....	20	1" Drive Sockets, Extensions & Adapters	
Frearson.....	21	SAE Sockets & Budd Wheel Sockets72
B.N.A.E.	21	Metric Sockets.....	.72
Socket Head.....	22	Extensions and Adapters.....	.72
Square Recess.....	24	1 1/2" Drive SAE Sockets & Adapters73
Pipe Plug Inserts	26	2 1/2" Drive SAE Sockets & Adapters73
Triple Square	27	Anti-Mar Protective Covers	
Torq-Set®.....	27	µ-Guard74
Mor Torq®.....	28	Free-Spin76
Tri-Wing®.....	29	Engineered Solutions78
Hi-Torque®.....	29	Special Sockets, Adapters & Accessories	
Bit Holders		Reversible Sockets.....	.80
Hex Drive	31	Valve Stem Drivers80
Female Square Drive	32	Ferry Cap® Sockets.....	.80
Hand Drivers		Tap Holding Sockets80
Replaceable Bit	34	Grease Fitting Sockets.....	.81
Awls	34	Drill Holders81
Hex Drive Nutsetters, Extensions & Universal Wrenches		Extensions & Adapters, Universal Wrenches and Budd Wheel Sockets81
Nutsetters.....	34	Socket Retaining Rings82
Extensions	35	Adapters.....	.82
Universal Wrenches.....	37	Screwdriver Bit Quotation Worksheet84
1/4" Drive Sockets, Extensions, Adapters & Universal Wrenches		Sockets Quotation Worksheet85
SAE Sockets and Universal Wrenches.....	41	Universal Wrench Quotation Worksheet86
Metric Sockets and Universal Wrenches	44	Part Number Index	87
Spline and Torx® Sockets.....	44	Conversion Tables	95
Extensions and Adapters.....	45		
3/8" Drive Sockets, Extensions, Adapters & Universal Wrenches			
SAE Sockets and Universal Wrenches.....	46		
Metric Sockets & Universal Wrenches	50		
Spline and Torx® Sockets.....	53		
Extensions and Adapters.....	54		
1/2" Drive Sockets, Extensions, Adapters & Universal Wrenches			
SAE Sockets and Universal Wrenches.....	55		
Metric Sockets & Universal Wrenches	60		
Spline and Torx® Sockets.....	64		
Extensions and Adapters.....	64		

Quick Reference

	Important Informations	2-6
	Bits	7-29
	Bit Holders	30-32
	Hand Drivers	34
	Hex Drive Nutsetters Extensions & Universal Wrenches	33-39
	1/4" Sockets, Extensions, Adapters & Universal Wrenches	40-45
	3/8" Sockets, Extensions, Adapters & Universal Wrenches	46-54
	1/2" Sockets, Extensions, Adapters & Universal Wrenches	55-65
	5/8" Sockets, Extensions, Adapters & Universal Wrenches	66-73
	μ-Protective Covers	74-78
	Special Sockets, Adapters & Accessories	80-83
	Part Number Index	87-95

The Apex heritage of

For more than half a century Apex has maintained a position of leadership in industrial fastening tools. Today, Apex stands ready to improve the productivity of assembly operations around the world with unsurpassed tool performance and customer service.

Precision Fit

Apex quality begins with select raw materials. Only carefully chosen, high grade tool steel is used. Each tool is manufactured to the tightest tolerances in the industry...most are even tighter than licensing agreement requirements. Our bits meet the most stringent government and military specifications where applicable (ie. MIL-B-9946/5 for HTS Hi-Torque® bits used in aerospace assembly).

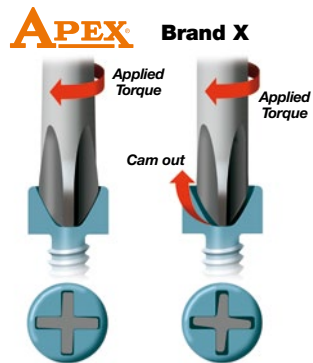

Precision fit of Apex tools eliminates "cam-out" and premature bit failure.

Apex sockets, nutsetters and universal wrenches have hex tolerances that are on average 48% tighter than DIN and 35% tighter than ANSI requirements. With Apex you are assured of an exact, sure fit.

All Apex sockets and extensions have the tightest tolerances for straightness and concentricity in the



Precision-manufactured Apex tools are virtually wobble-free.

industry. Tools that run true perform better and last longer.

Lasting Performance

Each Apex tool is tempered with our proprietary heat treating process that lets you select the degree of hardness your particular application requires. Choose from tough, non-brittle durability that stands up to torque, to the hardest heat treat available in the industry for the ultimate in wear resistance.



Apex bits & sockets last ten times longer than most of our competitors.

Apex offers a choice of three heat treat hardness levels in many of our screwdriver bits to match the application. These heat treats are specified by a letter suffix as follows:

- X - Hardest heat treat in the industry**
- I - Intermediate hardness**
- R - Lowest hardness**

Our experienced staff can help in selecting the best heat treat for your particular application.



quality, delivery and support

Innovative Solutions

Throughout our history Apex has partnered with the leading fastener manufacturers to assist in the development of new fastening technologies. Today, many of these new tools that are now common can trace their history back to Apex engineering.

Recently Apex introduced μ -Guard™ protective covers to satisfy the growing demand for products that prevent in-system damage.



Unsurpassed Offering

This catalog contains more than 3,000 of the most frequently requested bits, sockets and fastening accessories. Our entire active offering approaches 10,000 sellable part numbers. If the tool you need does not appear in this catalog, give us a call. The odds are, we may have what you need as a non-catalog item. If not, our experienced staff



of tooling experts can design and manufacture “specials” to meet the needs of your specific applications. You can even submit special requests on-line at our website www.apexpowertools.eu by completing the simple forms.

This flexibility has helped make Apex the only manufacturer which is a market and technology leader in all of the following industrial product categories: Bits & Bit Holders, Impact Sockets, Extensions and Universal Wrenches.

Availability & Service

Apex has approximately 2,000 authorized distributor locations globally to provide product off-the-shelf as well as knowledgeable service and support. Apex stocks over 1,000 part numbers and a multitude of blanks to manufacture several thousand more in order to support our strong global distribution network.



Important Notes

User safety tips

- Always wear safety glasses when using any tool.
- Always visually inspect tool for damage and cracking. Immediately replace all damaged tools.
- Do not modify or alter any tool.
- Do not use tools beyond their limit or useful life.
- Contact Apex for the recommended operating torque of any tool.

Selecting the proper heat treat for bits

Choosing the proper heat treat for screwdriver tools is important in achieving long tool life. Different applications, different operators, and different power tools require different heat treats. Apex offers a choice of three heat treat hardness levels in many of our screwdriver bits to match the particular customer's application. These heat treats are specified by a letter suffix as follows:

- X – The hardest heat treat in the industry**
- I - Intermediate hardness**
- R - Lowest hardness**

Selecting the heat treat best suited for a particular application may require some trial and error. The proper heat treat depends on the failure mode. If the bit breaks or shatters, select a bit with less hardness. If the failure mode is wear, select a harder bit. Many times both breakage and wear may occur within the same application. This can be due to a number of factors such as different operators, different torque values, and different power tool settings.

In general, high torque applications require "R" heat treats to withstand twisting and resist breakage. The "X" heat treat is most suitable for low torque applications, particularly if hardened screws are used.

If a failure occurs, a change in hardness may result in better service. The "X" heat treat is most common and should be selected unless the specifics of an application or an existing problem would suggest using "I" or "R" hardness.

To specify a particular heat treat, add a letter suffix to the part number. For example, to specify "X" hardness in a #2 Phillips insert, the part number would be 440-2X. Not all Apex bits are available in all heat treats. Special heat treats can be supplied for a particular application. Contact your Apex representative for specific recommendations.

Since "X" hardness is the most popular with our customers, it is our default product where "X" designation may be omitted from the part number. For all other hardness designations, the product packaging will be marked with the appropriate hardness designation letter.

Warning

- Using any adapter may result in a torque overload and failure in the adapter, socket or fastener.
- Do not use thin wall sockets with impact power tools.
- Do not use universal wrenches with impact power tools.

APEX® Solutions

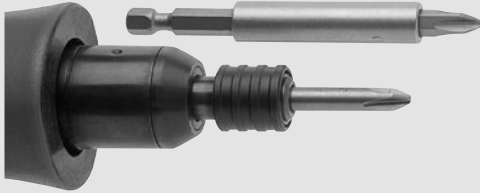

What's the difference between an insert and a power bit?

Insert bits are commonly used with a bit holder in power tool applications. This combination is economical, provides flexibility and allows a fastener to be magnetically held by the bit. Power bits are placed directly into the power tool chuck.

See pages 31–34 for a complete listing of Apex bit holders.

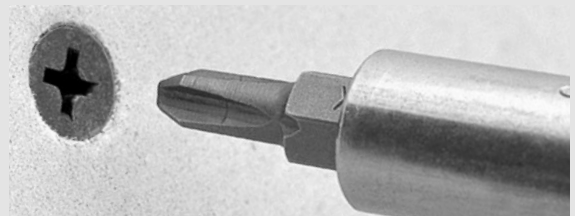

What's the advantage of reduced diameter bit?

Reduced diameter bits are ideal for driving screws below the surface of drywall.

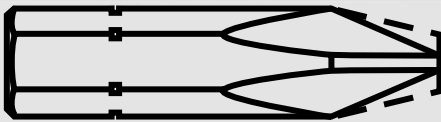

What's the advantage of 27 Series bits?

27 Series bits are ideal for poorly recessed Phillips screws. A wider tip design fills out an inexact recess to make better contact.

What's the advantage of Apex® ACR® Bits?

Painted, coated or corroded fasteners can present special problems.

Apex® ACR® insert bits' special wing-face ribs grip screw recesses to reduce stripping and cam-out which can result in damage to the surrounding workpiece. Choose from bits ribbed for screw removal, driving or both. They're also available in both insert bits and power drives.

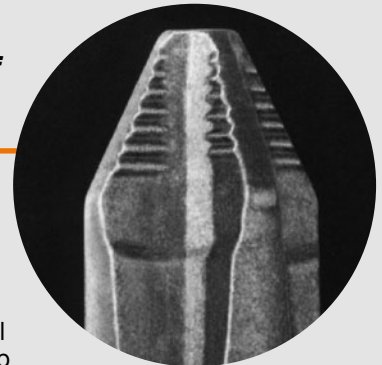

Why do Apex bits last so much longer?

Apex's premium tool alloys and proprietary heat treat help avoid typical problems such as shattering and premature bit wear.

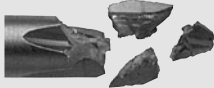

Most Apex bits are available in three different heat treat hardnesses.

Refer to page 6 for information on selecting the proper heat treat.

If the tool you need does not appear in this catalog, give us a call. The odds are, we may have what you need as a non-catalog item. If not, our experienced staff of tooling experts can design and manufacture "specials" to meet the needs of your specific application. Give us a call at +49 7363-81-129 or visit our website www.apexpowertools.eu

In this section:

Insert and Power Drive Bits



For all these fastener styles:

- Phillips®
- Slotted
- Torx®
- Torx Plus®
- Torx® Tamper Resistant
- Torx Plus® Tamper Resistant
- Pozidriv®
- Sel-o-fit®
- Quadrex®
- Frearson
- B.N.A.E.
- Socket Head
- Square Recess
- Torq-Set®
- MorTorq®
- Tri-Wing®
- Hi-Torque®
- Triple Square

Bit Holders, Nutsetters, Extensions and Universal Wrenches

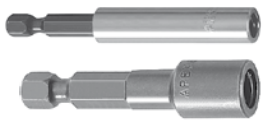

Bit holders adapt hex drive and female square drive power tools to a variety of insert bits. Hex drive nutsetters, extensions and universal wrenches allow nutrunning in all types of applications.

Selecting the correct Phillips point size

Apex bits in these five point sizes will drive ANY Phillips screw

Point Size	Woody Screws			Machine Screws			Sheet Metal Screws
	Body Dia.	Flat, Oval	Round	Flat, Oval, Binding	Round, Fillister	Truss, Brazler, Button	Flat, Round, Ovale Stove, Binding
1	3/16	2	2	2	2	2	2
1	3/16	2	2	2	2	2	2
	3	3	3	3	3	3	
	4	4	4	4	4	4	
	5	5	5	5	5	5	5
2	1/4	5	5	5	5	5	
	6	6	6	6	8	6	
	7	7	8	8	10	7	
	8	8	10	10	8		
	9	9	10				
3	10						
	5/16	10	12	12	12	12	12
	12	14	1/4	1/4	1/4	14	
	14	16	5/16				
4	16						
	3/8	18	18	5/16	3/8	5/16	
	20	20	3/8	7/16	3/8		
	24	24	7/16	1/2	7/16		
	1/2	1/2					

IMPORTANT The table above will enable you to determine the Phillips point size required for any Phillips screws or bolts. The No. 2 and No. 3 point sizes cover the range of Phillips screws most commonly used. The Apex Phillips bits on the following pages are available in point sizes to drive any Phillips screw.

Phillips-Bits

1/4" Hex Insert Bits



Part Number	Point Size	Overall Length		
		In.	mm	
440-1X	1	1	25	
440-115X	1	1 1/2	38	
440-12X	1	2	51	
440-125X	1	2 1/2	64	
440-13X	1	3	76	
440-2X	2	1	25	
440-2I	2	1	25	
440-215X	2	1 1/2	38	
440-22X	2	2	51	
440-225X	2	2 1/2	64	
440-23X	2	3	76	
440-24X	2	4	101	
440-255X	2	5 1/2	140	
440-26X	2	6	152	
440-27X*	2	1	25	For shallow screw recesses
440-3X	3	1	25	
440-3I	3	1	25	
440-3125X	3	1 1/4	32	
440-3BNX	3	1 1/4	32	Large Body
440-32X	3	2	51	
440-325X	3	2 1/2	64	
440-33X	3	3	76	
440-34X	3	4	101	
440-4X	4	1 5/16	33	

* For shallow screw recesses see Tool Tip on page 5.

1/4" Hex Insert Bits – Limited Clearance



Part Number	Point Size	Overall Length		Turned Length (A)		Turned OD (B)	
		In.	mm	In.	mm	In.	mm
446-0X	0	1	25	7/16	11	0,170	4,06
446-1X	1	1	25	7/16	11	0,170	4,06
446-12X	1	2	51	7/16	11	0,170	4,06
SD-1055-A	1	2	51	1 3/8	35	0,170	4,06
446-2X	2	1	25	7/16	11	0,170	4,06
446-2I	2	1	25	7/16	11	0,170	4,06
446-215X	2	1 1/2	38	7/16	11	0,170	4,06
446-22X	2	2	51	7/16	11	0,170	4,06
446-215T	2	1 1/2	38	1	25	0,170	4,06
446-22TX	2	2	51	1 1/2	38	0,170	4,06
446-225T	2	2 1/2	64	1 3/4	44	0,170	4,06
446-23T	2	3	76	2 1/4	57	0,170	4,06
446-27X*	2	1	25	7/16	11	0,170	4,06

* For shallow screw recesses see Tool Tip on page 5.

1/4" Hex Insert Bits – ACR®



Part Number	Point Size	Overall Length		
		In.	mm	
440-1-ACR1-RX	1	1	25	
440-1-ACR1-DX	1	1	25	
440-1-ACR1X	1	1	25	
440-2-ACR2-RX	2	1	25	
440-2-ACR2-RI	2	1	25	
440-2-ACR2-DX	2	1	25	
440-2-ACR2X	2	1	25	
446-2-ACR2-DX	2	1	25	Limited Clearance
440-22-ACR2-RX	2	2	51	
440-22-ACR2-DX	2	2	51	
440-22-ACR2X	2	2	51	
440-3-ACR3-RX	3	1	25	
440-3-ACR3-DX	3	1	25	
440-3-ACR3X	3	1	25	

Part number suffix -R
For removal



Part number suffix -D
For driving



No part number suffix
For both removal and driving



5/16" Hex Insert Bits



Part Number	Point Size	Overall Length		
		In.	mm	
480-1X	1	1 1/4	32	
480-2X	2	1 1/4	32	
480-22X	2	2	51	
480-225X	2	2 1/2	64	
480-24X	2	4	101	
480-3X	3	1 1/4	32	
480-325X	3	2 1/2	64	
480-34X	3	4	101	
480-4X	4	1 1/4	32	
480-4BNX	4	1 1/2	38	Large Body
480-425X	4	2 1/2	64	

5/16" Hex Insert Bits – ACR®



Part Number	Point Size	Overall Length	
		In.	mm
480-2-ACR2-RX	2	1 1/4	32
480-2-ACR2X	2	1 1/4	32
480-3-ACR3X	3	1 1/4	32
480-4-ACR4X	4	1 1/4	32

Part number suffix -R
For removal



Part number suffix -D
For driving



No part number suffix
For both removal and driving



Phillips-Bits

5/16" Square Insert Bits



Part Number	Point Size	Overall Length	
		In.	mm
830-1X	1	1 1/8	29
830-2X	2	1 1/8	29
830-3X	3	1 1/8	29
830-4X	4	1 1/8	29



1/4" Hex Power Drive

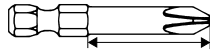

Part Number	Point Size	Overall Length		Shank Diameter		Turned Length	
		In.	mm	In.	mm	In.	mm
4910X	0	1 15/16	49	1/8	3,2	1 1/4	32
4910-AX	0	2 3/4	70	1/8	3,2	2	51
4910-BX	0	3 1/2	89	1/8	3,2	2 3/4	70
4910-CX	0	6	152	1/8	3,2	2	51
491X	1	1 15/16	49	3/16	4,8	1 1/4	32
491-AX	1	2 3/4	70	3/16	4,8	2	51
491-BX	1	3 1/2	89	3/16	4,8	2 3/4	70
491-CX	1	6	152	3/16	4,8	2	51
491-CCX	1	6	152	3/16	4,8	5 1/4	133
492X	2	1 15/16	49	1/4	6,4	1 1/4	32
492I	2	1 15/16	49	1/4	6,4	1 1/4	32
492-AX	2	2 3/4	70	1/4	6,4	2	51
492-AI	2	2 3/4	70	1/4	6,4	2	51
492-BX	2	3 1/2	89	1/4	6,4	2 3/4	70
492-BI	2	3 1/2	89	1/4	6,4	2 3/4	70
492-CX	2	6	152	1/4	6,4	2	51
492-CI	2	6	152	1/4	6,4	2	51
492-200MM	2	7 13/16	200	1/4	6,4	7	178
SD-2052-8	2	8	203	9/32	7,1	7	178
SD-2052-10	2	10	254	9/32	7,1	9	229
492-CCX	2	6	152	1/4	6,4	5 1/4	133
492-27X*	2	1 15/16	49	1/4	6,4	1 1/4	32
492-A-27X*	2	2 3/4	70	1/4	6,4	2	51
492-B-27X*	2	3 1/2	89	1/4	6,4	2 3/4	70
492-C-27X*	2	6	152	1/4	6,4	2	51
492-CC-27X*	2	6	152	1/4	6,4	5 1/4	133
493X	3	1 15/16	49	5/16	7,9	1	25
493-AX	3	2 3/4	70	5/16	7,9	1 3/4	44
493-BX	3	3 1/2	89	5/16	7,9	2 1/2	64
493-CX	3	6	152	5/16	7,9	5	127
4930X	3	1 15/16	49	1/4	6,4	1 1/4	32
4930-AX	3	2 3/4	70	1/4	6,4	2	51
4930-BX	3	3 1/2	89	1/4	6,4	2 3/4	70
4930-CX	3	6	152	1/4	6,4	2	51
4930-CCX	3	6	152	1/4	6,4	5 1/4	133
494X	4	1 15/16	49	3/8	9,5	1	25



1/4" Hex Power Drive – ACR®

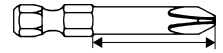

Part Number	Point Size	Overall Length		Shank Diameter		Turned Length	
		In.	mm	In.	mm	In.	mm
491-ACR1-RX	1	1 15/16	49	3/16	4,8	1 1/4	32
491-ACR1-DX	1	1 15/16	49	3/16	4,8	1 1/4	32
491-ACR1X	1	1 15/16	49	3/16	4,8	1 1/4	32
492-ACR2-RX	2	1 15/16	49	1/4	6,4	1 1/4	32
492-ACR2-DX	2	1 15/16	49	1/4	6,4	1 1/4	32
492-ACR2X	2	1 15/16	49	1/4	6,4	1 1/4	32
492-A-ACR2-DX	2	2 3/4	70	1/4	6,4	2	51
492-A-ACR2X	2	2 3/4	70	1/4	6,4	2	51
492-B-ACR2-DX	2	3 1/2	89	1/4	6,4	2 3/4	70
492-B-ACR2X	2	3 1/2	89	1/4	6,4	2 3/4	70
492-C-ACR2-DX	2	6	152	1/4	6,4	2	51
493-ACR3X	3	1 15/16	49	5/16	7,9	1	25

Part number suffix -R
For removal



Part number suffix -D
For driving



No part number suffix
For both removal and driving



1/4" Hex Power Drive with Finder Sleeve



Part Number	Point Size	Overall Length		Sleeve Diameter	
		In.	mm	In.	mm
SD-556-A	2	3 1/2	89	7/16	11,1
SD-556	2	6	152	7/16	11,1



7/16" Hex Power Drive

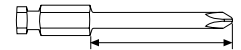

Part Number	Point Size	Overall Length		Shank Diameter		Turned Length	
		In.	mm	In.	mm	In.	mm
482X	2	3 1/2	89	1/4	6,4	2 1/4	57
483X	3	3 1/2	89	5/16	7,9	2 1/4	57
484X	4	3 1/2	89	3/8	9,5	2 1/4	57



9/32" No. 130A Yankee Drive

Part Number	Point Size	Overall Length		Shank Diameter	
		In.	mm	In.	mm
451X	1	3 1/4	83	3/16	4,8
452X	2	3 1/4	83	9/32	7,1
453X	3	3 1/4	83	5/16	7,9

* For shallow screw recesses. See Tool Tip on page 5.

ACR® is a trademark of the Phillips Screw Co.

Phillips-Bits



10-32 Screw Shank Drive

Part Number	Point Size	Overall Length		Shank Diameter	
		In.	mm	In.	mm
501X	1	1 1/2	38	3/16	4,8
501-AX	1	1 13/16	46	3/16	4,8
502X	2	1 1/2	38	1/4	6,4
502-ACR2X*	2	1 1/2	38	1/4	6,4
SD-1342-2	2	1 3/4	45	1/4	6,4
502-AX	2	1 13/16	46	1/4	6,4
503X	3	1 1/2	38	5/16	7,9

*Features ACR® anti-camout ribs. See Tool Tip on page 3.

If the tool you need does not appear in this catalog, give us a call. The odds are, we may have what you need as a non-catalog item. If not, our experienced staff of tooling experts can design and manufacture "specials" to meet the needs of your specific application.

Give us a call at +49 7363-81-129 or visit our website www.apexpowertools.eu.

12-24 Screw Shank Drive



Part Number	Point Size	Overall Length		Shank Diameter	
		In.	mm	In.	mm
551X	1	1 3/16	30	,30	7,6
552X	2	1 3/16	30	,30	7,6
552I	2	1 3/16	30	,30	7,6
553X	3	1 3/16	30	,30	7,6

1/4"-24 Screw Shank Drive



Part Number	Point Size	Overall Length		Shank Diameter	
		In.	mm	In.	mm
401X	1	1 1/2	38	3/16	4,8
402X	2	1 1/2	38	1/4	6,4
403X	3	1 1/2	38	5/16	7,9

8-32 Screw Shank Drive



Part Number	Point Size	Overall Length		Shank Diameter	
		In.	mm	In.	mm
591X	1	1 3/16	30	7/32	5,6
592X	2	1 3/16	30	7/32	5,6

Female Square Service Drive



Part Number	Female Square Drive	Point Size	Overall Length		Shank Diameter	
			In.	mm	In.	mm
821	1/4	1	2	51	1/4	6,4
822	1/4	2	2	51	1/4	6,4
832	3/8	2	2 5/8	67	5/16	7,9
833	3/8	3	2 5/8	67	5/16	7,9
834	3/8	4	2 5/8	67	5/16	7,9
852	1/2	2	2 7/8	73	5/16	7,9
853	1/2	3	2 7/8	73	5/16	7,9
854	1/2	4	2 7/8	73	3/8	9,5



Lösungen

Does Apex offer Torx® bits?

Torx® fasteners are becoming more and more common in automotive and appliance assembly. Apex provides a full selection of bits for Torx screws.

(See page 16–19)

Torx® is a trademark of the Camcar Division of Textron.

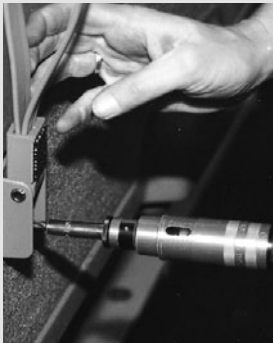

Is there an easy way to select a bit?

Take the guesswork out of bit selection. Apex Phillips and Torx® ring gauges help you find the right bit for your fasteners. Order SD-3749 for Phillips and SD-4064-G for Torx®.



What is a finder sleeve?

A finder sleeve makes it easy to engage slotted fasteners with the bit. It guides the bit so there is less "searching" for the proper alignment between blade and slot.



(See page 15)

If the tool you need does not appear in this catalog, give us a call. The odds are, we may have what you need as a non-catalog item. If not, our experienced staff of tooling experts can design and manufacture "specials" to meet the needs of your specific application.

Give us a call at +49 7363-81-129 or visit our website www.apexpowertools.eu

Why do Apex bits last so much longer than other bits?

Apex's premium tool alloys and proprietary heat treat help avoid typical problems such as shattering and premature bit wear. Most Apex bits are available in three different heat treat hardnesses.

Refer to page 6 for information on selecting the proper heat treat.



What's the difference between Torx® and Torx Plus® Bits?

Torx Plus®-bits and fasteners feature a greater engagement area for higher torque transfer and reduced camout when driving Torx Plus® fasteners.

They can provide up to 100% more drive cycles. Torx Plus® bits are not compatible with standard Torx® fasteners.



(See page 16-19)

Torx Plus® is a trademark of Acument Intellectual Properties, LLC. Torx Plus® Tamper Resistant Bits are available on a limited basis. Please contact your Area Distributor or Representative for more details.

Does Apex offer fastener tools for the aircraft industry?

Apex offers a full selection of fastener tools common to aircraft assembly and maintenance, including Tri-Wing®, Torq-Set®, Hi-Torque® and Phillips.



(See pages 27-29)



Torq-Set® and ACR® are registered trademarks of the Phillips Screw Co.

Does Apex offer mar resistant bits and sockets?

Apex can nylon coat just about any of our bits or sockets. Nylon offers excellent mar resistance for assemblies that have painted, varnished or chromed surfaces. Nylon also offers some safety benefits by covering tool junctions.

(See pages 74-76 for more information)



How do Torxalign® bits work?

Torxalign bits “wedge” into the Torx® recess to firmly hold the fastener to the bit.

(See page 16)

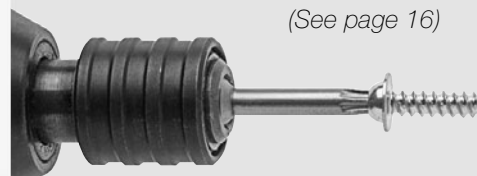

What's the difference between a Phillips and a Pozidriv® screw?

The shallow “cross” indentation in the screw head identifies a Pozidriv® fastener. The Pozidriv® bit and recess design provides contact than a standard Phillips for more torque with less possibility of camout.

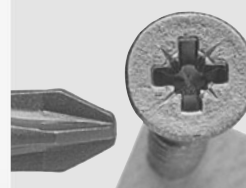

(See page 19)

Slotted Screw Sizes

Types of Heads

Note: When ordering slotted bits, please remember that head sizes and slot widths of hardened, self tapping, and sheet metal screws do not conform to the same specifications as standard wood or machine screws described in the chart below. Also, because of variations in these dimensions among screws from different manufacturers, bits should be ordered to head and slot size rather than screw size.

Screw Sizes	Flat Head		Round Head		Truss Head	Binding Head	Fillister Cap		Pan Head	Width of slot
	Wood	Mach.	Wood	Mach.			Cap	Mach.		
1	,146	,146	,138	,138			,118			,026
	,130	,130	,122	,122			,104			,019
2	,172	,172	,162	,162	,194	,181	,140	,167		,031
	,156	,156	,146	,146	,180	,171	,124	,155		,023
3	,199	,199	,187	,187	,226	,208	,161	,193		,035
	,181	,181	,169	,169	,211	,197	,145	,180		,027
4	,225	,225	,211	,211	,257	,235	,183	,219		,039
	,207	,207	,193	,193	,241	,223	,166	,205		,031
5	,252	,252	,236	,236	,289	,263	,205	,245		,043
	,232	,232	,217	,217	,272	,249	,187	,231		,035
6	,279	,279	,260	,260	,321	,290	,226	,270		,048
	,257	,257	,240	,240	,303	,275	,208	,256		,039
7	,305		,285		,352			,296		,048
	,283		,264		,333			,281		,039
8	,332	,332	,309	,309	,384	,344	,270	,322		,054
	,308	,308	,287	,287	,364	,326	,250	,306		,045
9	,358		,334							,054
	,334		,311							,045
10	,385	,385	,359	,359	,448	,339	,313	,373		,060
		,359	,334	,334	,425	,378	,292	,357		,050
12	,438	,438	,408	,408	,511	,454	,357	,425		,067
	,410	,410	,382	,382	,487	,430	,334	,407		,056
14	,491		,457							,075
	,461		,424							,064
1/4"		,507		,472	,573	,513	,375	,414	,492	,075
		,477		,443	,546	,488	,363	,389	,473	,064
16	,544		,506							,075
	,512		,476							,064
18	,597		,555							,084
	,563		,523							,072
5/16"		,635		,590	,698	,641	,437	,518	,615	,084
		,600		,557	,666	,609	,424	,490	,594	,072
20	,650		,604							,084
	,614		,570							,072
24	,756		,702							,094
	,716		,664							,081
3/8"		,762		,708	,823	,769	,562	,622	,740	,094
		,722		,670	,787	,731	,547	,590	,716	,081

Slotted-Bits



1/4" Hex Insert Bits – Limited Clearance



Part Number	Screw Size	Overall Length		Blade Thickness		Blade Width	
		In.	mm	In.	mm	In.	mm
445-000X	1F-2R	1	25	,021	,53	,125	3,2
445-00X	2F-3R	1	25	,025	,64	,140	3,6
445-0X	3F-4R	1	25	,030	,76	,154	3,9
445-10X	4F-5R	1	25	,034	,86	,185	4,7
445-20X	5F-6R	1	25	,036	,91	,216	5,5
445-30X	6F-7R	1	25	,038	,97	,248	6,3
445-00-15X	2F-3R	1 1/2	38	,028	,71	,138	3,5
445-0-15X	3F-4R	1 1/2	38	,032	,81	,154	3,9
445-10-15X	4F-5R	1 1/2	38	,034	,86	,185	4,7
445-20-15X	5F-6R	1 1/2	38	,036	,91	,216	5,5
445-30-15X	6F-7R	1 1/2	38	,038	,97	,248	6,3



1/4" Hex Insert Bits



Part Number	Screw Size	Overall Length		Blade Thickness		Blade Width	
		In.	mm	In.	mm	In.	mm
445-1X	4F-5R	1	25	,034	,86	3/16	4,8
445-2X	6F-8R	1	25	,040	1,02	7/32	5,6
445-3X	8F-10R	1	25	,042	1,07	1/4	6,4
445-4X	10F-12R	1	25	,046	1,17	9/32	7,1
445-1-15X	4F-5R	1 1/2	38	,034	,86	3/16	4,8
445-2-15X	6F-8R	1 1/2	38	,040	1,02	7/32	5,6
445-3-15X	8F-10R	1 1/2	38	,042	1,07	1/4	6,4
445-4-15X	10F-12R	1 1/2	38	,046	1,17	9/32	7,1
445-5X	12F-14R	1 1/2	38	,050	1,27	5/16	7,9
445-6X	14F-16R	1 1/2	38	,055	1,40	23/64	9,1

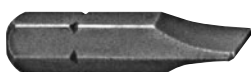

5/16" Hex Insert Bits



Part Number	Screw Size	Overall Length		Blade Thickness		Blade Width	
		In.	mm	In.	mm	In.	mm
485-1X	4F-5R	1 1/2	38	,034	,86	3/16	4,8
485-2X	6F-8R	1 1/2	38	,040	1,02	7/32	5,6
485-3X	8F-10R	1 1/2	38	,042	1,07	1/4	6,4
485-4X	10F-12R	1 1/2	38	,046	1,17	,296	7,52
485-5X	12F-14R	1 1/2	38	,050	1,27	,328	8,33
485-6X	14F-16R	1 1/2	38	,055	1,40	,328	8,33
485-7X	16F-18R	1 3/4	45	,060	1,52	1/2	12,7



1/4" Hex Power Drive



Part Number	Screw Size	Overall Length		Blade Thickness		Blade Width/ Shank Diameter	
		In.	mm	In.	mm	In.	mm
320-000X	1F-2R	1 15/16	49	,022	,56	,122	3,10
326-000X	1F-2R	2 3/4	70	,022	,56	,122	3,10
323-000X	1F-2R	3	76	,022	,56	,122	3,10
327-000X	1F-2R	3 1/2	89	,022	,56	,122	3,10
324-000X	1F-2R	4	102	,022	,56	,122	3,10
325-000X	1F-2R	5	127	,022	,56	,122	3,10
328-000X	1F-2R	6	152	,022	,56	,122	3,10
320-00X	2F-3R	1 15/16	49	,026	,66	,134	3,40
326-00X	2F-3R	2 3/4	70	,026	,66	,134	3,40
323-00X	2F-3R	3	76	,026	,66	,134	3,40
327-00X	2F-3R	3 1/2	89	,026	,66	,134	3,40
324-00X	2F-3R	4	102	,026	,66	,134	3,40
325-00X	2F-3R	5	127	,026	,66	,134	3,40
328-00X	2F-3R	6	152	,026	,66	,134	3,40
320-0X	3F-4R	1 15/16	49	,030	,76	,151	3,84
326-0X	3F-4R	2 3/4	70	,030	,76	,151	3,84
323-0X	3F-4R	3	76	,030	,76	,151	3,84
327-0X	3F-4R	3 1/2	89	,030	,76	,151	3,84
324-0X	3F-4R	4	102	,030	,76	,151	3,84
325-0X	3F-4R	5	127	,030	,76	,151	3,84
328-0X	3F-4R	6	152	,030	,76	,151	3,84
320-1X	4F-5R	1 15/16	49	,034	,86	,187	4,75
326-1X	4F-5R	2 3/4	70	,034	,86	,187	4,75
323-1X	4F-5R	3	76	,034	,86	,187	4,75
327-1X	4F-5R	3 1/2	89	,034	,86	,187	4,75
324-1X	4F-5R	4	102	,034	,86	,187	4,75
325-1X	4F-5R	5	127	,034	,86	,187	4,75
328-1X	4F-5R	6	152	,034	,86	,187	4,75
320-20X	5F-6R	1 15/16	49	,036	,91	,215	5,46
326-20X	5F-6R	2 3/4	70	,036	,91	,215	5,46
323-20X	5F-6R	3	76	,036	,91	,215	5,46
327-20X	5F-6R	3 1/2	89	,036	,91	,215	5,46
324-20X	5F-6R	4	102	,036	,91	,215	5,46
325-20X	5F-6R	5	127	,036	,91	,215	5,46
328-20X	5F-6R	6	152	,036	,91	,215	5,46
320-2X	5F-6R	1 15/16	49	,036	,91	,250	6,35
326-2X	5F-6R	2 3/4	70	,036	,91	,250	6,35
323-2X	5F-6R	3	76	,036	,91	,250	6,35
327-2X	5F-6R	3 1/2	89	,036	,91	,250	6,35
324-2X	5F-6R	4	102	,036	,91	,250	6,35
328-2X	5F-6R	6	152	,036	,91	,250	6,35
320-3X	6F-8R	1 15/16	49	,038	,97	,250	6,35
326-3X	6F-8R	2 3/4	70	,038	,97	,250	6,35
323-3X	6F-8R	3	76	,038	,97	,250	6,35
327-3X	6F-8R	3 1/2	89	,038	,97	,250	6,35
324-3X	6F-8R	4	102	,038	,97	,250	6,35
325-3X	6F-8R	5	127	,038	,97	,250	6,35
328-3X	6F-8R	6	152	,038	,97	,250	6,35
320-4X	8F-10R	1 15/16	49	,042	1,07	,275	6,99
326-4X	8F-10R	2 3/4	70	,042	1,07	,275	6,99
323-4X	8F-10R	3	76	,042	1,07	,275	6,99
327-4X	8F-10R	3 1/2	89	,042	1,07	,275	6,99
324-4X	8F-10R	4	102	,042	1,07	,275	6,99
325-4X	8F-10R	5	127	,042	1,07	,275	6,99
328-4X	8F-10R	6	152	,042	1,07	,275	6,99
320-5X	10F-12R	1 15/16	49	,046	1,17	,312	7,92
326-5X	10F-12R	2 3/4	70	,046	1,17	,312	7,92
323-5X	10F-12R	3	76	,046	1,17	,312	7,92
327-5X	10F-12R	3 1/2	89	,046	1,17	,312	7,92
324-5X	10F-12R	4	102	,046	1,17	,312	7,92
325-5X	10F-12R	5	127	,046	1,17	,312	7,92
328-5X	10F-12R	6	152	,046	1,17	,312	7,92
320-6X	12F-14R	1 15/16	49	,050	1,27	,360	9,14
326-6X	12F-14R	2 3/4	70	,050	1,27	,360	9,14
323-6X	12F-14R	3	76	,050	1,27	,360	9,14
327-6X	12F-14R	3 1/2	89	,050	1,27	,360	9,14
324-6X	12F-14R	4	102	,050	1,27	,360	9,14
325-6X	12F-14R	5	127	,050	1,27	,360	9,14
328-6X	12F-14R	6	152	,050	1,27	,360	9,14

Slotted Bits



5/16" Hex Power Drive

Part Number	Screw Size	Length		Blade Thickness		Blade Width/ Body Diameter	
		In.	mm	In.	mm	In.	mm
635-6X	10F-12R	2 1/4	57	,046	1,17	,360	9,14
635-7X	12F-14R	2 1/4	57	,050	1,27	,395	10,03
635-8X	14F-16R	2 1/4	57	,055	1,40	,457	11,61
635-9X	16F-20R	2 1/4	57	,060	1,52	,503	12,78
635-10X	20F-22R	2 1/4	57	,062	1,57	,545	13,84



10-32 Screw Shank Drive

Part Number	Screw Size	Length		Blade Thickness		Blade Width/ Body Diameter	
		In.	mm	In.	mm	In.	mm
103-00X	2F-3R	1 1/2	38	,026	,66	,140	3,56
103-1X	4F-5R	1 1/2	38	,034	,86	,187	4,75
103-2X	5F-6R	1 1/2	38	,036	,91	,225	5,72
103-3X	6F-7R	1 1/2	38	,038	,97	,250	6,35
103-4X	7F-8R	1 1/2	38	,040	1,02	,275	7,24
103-5X	8F-10R	1 1/2	38	,042	1,07	,296	7,52
103-6X	10F-12R	1 1/2	38	,046	1,17	,309	7,85



1/4"-24 Screw Shank Drive

Part Number	Screw Size	Length		Blade Thickness		Blade Width/ Body Diameter	
		In.	mm	In.	mm	In.	mm
309-000X	1F-2R	1 1/2	38	,022	,56	,125	3,18
309-00X	2F-3R	1 1/2	38	,026	,66	,140	3,56
309-1X	4F-5R	1 1/2	38	,034	,86	,187	4,75
309-2X	5F-6R	1 1/2	38	,036	,91	,225	5,72
309-3X	6F-7R	1 1/2	38	,038	,97	,250	6,35
309-4X	7F-8R	1 1/2	38	,040	1,02	,285	7,24
309-5X	8F-10R	1 1/2	38	,042	1,07	,296	7,52
309-6X	10F-12R	1 1/2	38	,046	1,17	,315	8,00
309-8X	14F-16R	1 1/2	38	,055	1,40	,361	9,17

If the tool you need does not appear in this catalog, give us a call. The odds are, we may have what you need as a non-catalog item. If not, our experienced staff of tooling experts can design and manufacture "specials" to meet the needs of your specific application. Give us a call at +49 7363-81-129 or visit our website www.apexpowertools.eu.

Slotted Bits

1/4" Power Drive with Finder Sleeves

Note: Each finder sleeve assembly part number begins with a letter prefix that denotes the particular sleeve used with that assembly. The chart below gives complete dimensional data for each finder sleeve.

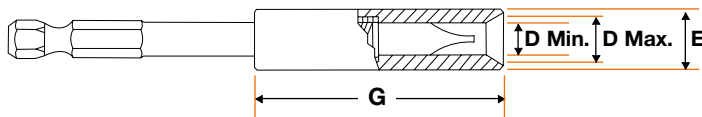

Part Number	Screw Size	D Max.		D Min.		Sleeve Length G		Sleeve Diameter E	
		Size	In.	mm	In.	mm	In.	mm	In.
L	5F-6R	,260	6,60	,233	5,92	1 7/8	47,6	3/8	9,5
M	6F-6R	,309	7,85	,261	6,63	1 7/8	47,6	7/16	11,1
P	8F-6R	,368	9,35	,310	7,87	1 7/8	47,6	1/2	12,7
NP*	8F-10R	,368	9,35	,310	7,87	1 7/8	47,6	7/16	11,1
R	10F-12R	,415	10,54	,369	9,37	2	50,8	9/16	14,3
S	12F-14R	,478	12,14	,416	10,57	2	50,8	5/8	15,9
T	14F-16R	,522	13,26	,479	12,17	2 1/8	54,0	11/16	17,5
U	16F-20R	,621	15,77	,523	13,28	2 1/8	54,0	3/4	19,1
W	20F-22R	,665	16,89	,622	15,80	2 1/16	52,4	13/16	20,3
Y	24F-24R	,715	18,16	,666	16,92	2 1/32	51,6	15/16	23,8

*Sleeve NP is a cup Type sleeve.

Slotted Power Bits with Finder Sleeves



1/4" Hex Power Drive



Part Complete Assembly	Part Number nur Bit	Screw Size	Length		Blade Thickness		Blade Width/SchaftDiameter	
			In.	mm	In.	mm	In.	mm
L-320X	320-LX	5F-6R	3 3/4	95	,036	,91	,193	4,90
M-320X	320-MX	6F-8R	3 3/4	95	,038	,97	,241	6,12
P-320X	320-PX	8F-10R	3 3/4	95	,042	1,07	,290	7,37
R-320X	320-RX	10F-12R	3 3/4	95	,046	1,17	,350	8,89
S-320X	320-SX	12F-14R	3 7/8	98	,050	1,27	,395	10,03
T-320X	320-TX	14F-16R	4 1/8	105	,055	1,40	,457	11,61

1/4" Hex Power Drive – Extra Short Series

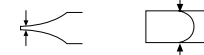

Part Complete Assembly	Part Number nur Bit	Screw Size	Length		Blade Thickness		Blade Width/SchaftDiameter	
			In.	mm	In.	mm	In.	mm
OOOL-322X	322-000LX	2F-3R	2 3/32	53	,026	,66	,138	3,91
OOL-322X	-	3F-4R	2 3/32	53	,030	,76	,154	3,91
OL-322X	322-OLX	4F-5R	2 5/32	55	,034	,86	,185	4,70
L-322X	-	5F-6R	2 5/32	55	,036	,91	,185	4,70
M-322X	322-MX	6F-8R	2 5/32	55	,040	1,02	,248	6,30
P-322X	-	8F-10R	2 5/32	55	,042	1,07	,283	7,19
R-322X	-	10F-12R	2 5/32	55	,046	1,17	,283	7,19



1/4" Hex Power Drive – Long Series



Part No. Complete Assembly	Part Number Bit only	Screw Size	Length		Blade Thickness		Bit Body Diameter	
			In.	mm	In.	mm	In.	mm
L-328X	328-LX	5F-6R	6 1/2	165	,036	,91	,193	4,90
M-328X	328-MX	6F-8R	6 1/2	165	,038	,97	,241	6,12
P-328X	328-PX	8F-10R	6 1/2	165	,046	1,07	,290	7,37
R-328X	328-RX	10F-12R	6 1/2	165	,046	1,17	,350	8,89
S-328X	328-SX	12F-14R	6 1/2	165	,050	1,27	,395	10,03

7/16" Hex Power Drive with Finder Sleeves



Part Number	Screw Size	Bit Length		Blade Thickness		Bit Body Diameter	
		In.	mm	In.	mm	In.	mm
R-321X	10F-12R	3 7/8	98	,046	1,17	,350	8,89
S-321X	12F-14R	3 7/8	98	,050	1,27	,395	10,03
T-321X	14F-16R	4 1/8	105	,055	1,40	,457	11,61
U-321X	16F-20R	4 1/8	105	,060	1,52	,503	12,78
W-321X	20F-22R	4 1/8	105	,062	1,57	,545	13,84
Y-321X	24F-24R	4 1/8	105	,065	1,65	,595	15,11

See chart on page 14 for sleeve diameters.

Torx® Bits



1/4" Hex Insert Bits

Part Number	Part Number Torxalign®	Driver Size		Overall Length	
				In.	mm
440-TX-05X	-	T-5	,055	1	25
440-TX-06X	-	T-6	,065	1	25
440-TX-07X	-	T-7	,077	1	25
440-TX-08X	-	T-8	,090	1	25
440-TX-09X	-	T-9	,097	1	25
440-TX-10X	440-TX-10-W	T-10	,107	1	25
440-TX-15X	440-TX-15-W	T-15	,128	1	25
440-TX-15-125	-	T-15	,128	1 1/4	32
440-TX-20X	440-TX-20-W	T-20	,151	1	25
440-TX-20-125	-	T-20	,151	1 1/4	32
440-TX-20-2	-	T-20	,151	2	51
440-TX-25X	440-TX-25-W	T-25	,173	1	25
440-TX-27X	440-TX-27-W	T-27	,195	1	25
440-TX-30X	440-TX-30-W	T-30	,216	1	25
440-TX-40X	440-TX-40-W	T-40	,260	1	25
440-TX-40I	440-TX-40-W	T-40	,260	1	25
440-TX-45X*	-	T-45	,306	1 1/4	32
440-TX-50X*	-	T-50	,346	1 1/4	32

* Hex will break before rated ultimate torque of the Torx® point is met.



1/4" Hex Insert Bits – Tamper Resistant**

Part Number	Driver-Size		Overall Length	
			In.	mm
440-TX-07-H	T-7-H	,077	1	25
440-TX-08-H	T-8-H	,090	1	25
440-TX-09-H	T-9-H	,097	1	25
440-TX-10-H	T-10-H	,107	1	25
440-TX-15-H	T-15-H	,128	1	25
440-TX-20-H	T-20-H	,151	1	25
440-TX-25-H	T-25-H	,173	1	25
440-TX-27-H	T-27-H	,195	1	25
440-TX-30-H	T-30-H	,216	1	25
440-TX-40-H	T-40-H	,260	1	25

** Tamper resistant Torx® screws feature a post in the center of the recess—this post will only fit into a tamper resistant Torx® bit. Tamper resistant Torx® bits are available on a restricted distribution basis. Contact your local Apex representative for details.



5/16" Hex Insert Bits

Part Number	Driver Size		Overall Length	
			In.	mm
480-TX-20X	T-20	,151	1 1/4	32
480-TX-25X	T-25	,173	1 1/4	32
480-TX-27X	T-27	,195	1 1/4	32
480-TX-30X	T-30	,216	1 1/4	32
480-TX-40X	T-40	,260	1 1/4	32
480-TX-40-4X	T-40	,260	4	102
480-TX-45X	T-45	,306	1 1/4	32
480-TX-45-6	T-45	,306	6	152
480-TX-50X	T-50	,346	1 1/4	32
480-TX-55X	T-55	,440	1 1/4	32



5/16" Hex Insert Bits – Tamper Resistant**

Part Number	Driver Size		Overall Length	
			In.	mm
480-TX-40-H	T-40-H	,260	1 1/4	32
480-TX-45-H	T-45-H	,306	1 1/4	32
480-TX-50-H	T-50-H	,346	1 1/4	32
480-TX-55-H	T-55-H	,440	1 1/4	32

** Tamper resistant Torx® bits are available on a restricted distribution basis. Contact your local Apex representative for details.



5/8" Hex Insert Bits

Part Number	Hex Flat Type*	Driver Size		Overall Length	
				In.	mm
SZ-TX-55-A	DP	T-55	,440	1 9/16	40
SZ-TX-60-A	DP	T-60	,520	1 9/16	40
SZ-TX-70-A	DP	T-70	,610	1 9/16	40
SZ-TX-70-A-3	TH	T-70	,610	3	76
SZ-TX-80-A	TH	T-80	,689	1 9/16	40

*DP-Drill Point; TH-Thru Hole. 5/8" insert bits are used with SC and RP adapters found on pages 51.



7/8" Hex Insert Bits

Part Number	Hex Flat Type*	Screw Size		Overall Length	
				In.	mm
SZ-TX-90-A	TH	T-90	,782	2	51
SZ-TX-100-A	TH	T-100	,870	2	51

*TH-Thru Hole. 7/8" insert bits are used with RP adapters found on pages 51.

Torx® Bits



1/4" Hex Power Drive

Part Number	Driver Size		Body Diameter		Overall Length	
			In.	mm	In.	mm
49-TX-05	T-5	,055	,119	3,0	1 15/16	49
49-A-TX-05	T-5	,055	,119	3,0	2 3/4	70
49-B-TX-05	T-5	,055	,119	3,0	3 1/2	89
49-TX-06	T-6	,065	,119	3,0	1 15/16	49
49-A-TX-06	T-6	,065	,119	3,0	2 3/4	70
49-TX-07	T-7	,077	,119	3,0	1 15/16	49
49-A-TX-07	T-7	,077	,119	3,0	2 3/4	70
49-B-TX-07	T-7	,077	,119	3,0	3 1/2	89
49-C-TX-07	T-7	,077	,119	3,0	6	152
49-TX-08	T-8	,090	,119	3,0	1 15/16	49
49-A-TX-08	T-8	,090	,119	3,0	2 3/4	70
49-B-TX-08	T-8	,090	,119	3,0	3 1/2	89
49-C-TX-08	T-8	,090	,119	3,0	6	152
49-TX-09	T-9	,097	,119	3,0	1 15/16	49
49-A-TX-09	T-9	,097	,119	3,0	2 3/4	70
49-B-TX-09	T-9	,097	,119	3,0	3 1/2	89
49-C-TX-09	T-9	,097	,119	3,0	6	152
49-TX-10	T-10	,107	,150	3,8	1 15/16	49
49-A-TX-10	T-10	,107	,150	3,8	2 3/4	70
SD-4693	T-10	,107	,150	3,8	3	75
49-B-TX-10	T-10	,107	,150	3,8	3 1/2	89
49-C-TX-10	T-10	,107	,150	3,8	6	152
49-TX-15	T-15	,128	,150	3,8	1 15/16	49
49-A-TX-15	T-15	,128	,150	3,8	2 3/4	70
49-B-TX-15	T-15	,128	,150	3,8	3 1/2	89
49-C-TX-15	T-15	,128	,150	3,8	6	152
49-TX-20	T-20	,151	,171	4,3	1 15/16	49
49-A-TX-20	T-20	,151	,171	4,3	2 3/4	70
49-B-TX-20	T-20	,151	,171	4,3	3 1/2	89
49-TX-20-5	T-20	,151	,171	4,3	5	127
49-C-TX-20	T-20	,151	,171	4,3	6	152
49-TX-25	T-25	,173	,193	4,9	1 15/16	49
49-A-TX-25	T-25	,173	,193	4,9	2 3/4	70
49-B-TX-25	T-25	,173	,193	4,9	3 1/2	89
49-C-TX-25	T-25	,173	,193	4,9	6	152
49-TX-27	T-27	,195	,215	5,5	1 15/16	49
49-A-TX-27	T-27	,195	,215	5,5	2 3/4	70
49-B-TX-27	T-27	,195	,215	5,5	3 1/2	89
49-C-TX-27	T-27	,195	,215	5,5	6	152
49-TX-30	T-30	,216	,236	6,0	1 15/16	49
49-A-TX-30	T-30	,216	,236	6,0	2 3/4	70
49-B-TX-30	T-30	,216	,236	6,0	3 1/2	89
49-C-TX-30	T-30	,216	,236	6,0	6	152
49-TX-40	T-40	,260	,309	7,8	1 15/16	49
49-A-TX-40	T-40	,260	,309	7,8	2 3/4	70
49-B-TX-40	T-40	,260	,309	7,8	3 1/2	89
49-C-TX-40	T-40	,260	,309	7,8	6	152



1/4" Hex Power Drive – Torxalign®

Part Number	Driver Size		Body Diameter		Overall Length	
			In.	mm	In.	mm
49-TX-08-W	T-8	,090	,119	3,0	1 15/16	49
49-TX-10-W	T-10	,107	,150	3,8	1 15/16	49
49-TX-15-W	T-15	,128	,150	3,8	1 15/16	49
49-A-TX-15-W	T-15	,128	,150	3,8	2 3/4	70
49-B-TX-15-W	T-15	,128	,150	3,8	3 1/2	89
49-TX-20-W	T-20	,151	,171	4,3	1 15/16	49
49-B-TX-20-W	T-20	,151	,171	4,3	3 1/2	89
49-TX-25-W	T-25	,173	,193	4,9	1 15/16	49
49-TX-27-W	T-27	,195	,215	5,5	1 15/16	49
49-TX-30-W	T-30	,216	,236	6,0	1 15/16	49
49-B-TX-30-W	T-30	,216	,236	6,0	3 1/2	89



1/4" Hex Power Drive – Tamper Resistant**

Part Number	Driver Size		Body Diameter		Overall Length	
			In.	mm	In.	mm
49-TX-10-H	T-10-H	,107	,150	3,8	1 15/16	49
49-A-TX-10-H	T-10-H	,107	,150	3,8	2 3/4	70
49-TX-15-H	T-15-H	,128	,150	3,8	1 15/16	49
49-A-TX-15-H	T-15-H	,128	,150	3,8	2 3/4	70
49-B-TX-15-H	T-15-H	,128	,150	3,8	3 1/2	89
49-A-TX-20-H	T-20-H	,151	,171	4,3	2 3/4	70
49-B-TX-20-H	T-20-H	,151	,171	4,3	3 1/2	89
49-C-TX-20-H	T-20-H	,151	,171	4,3	6	152

** Tamper resistant Torx® bits are available on a restricted distribution basis.
+Contact your local Apex representative for details.



1/4" Hex Power Drive with Finder Sleeves

Number	Driver Size	Sleeve Number*		Sleeve Diameter		Overall Length	
				In.	mm	In.	mm
M-32-TX-15	T-15	M	,128	,437	12,1	3 1/2	89
M-32-TX-20	T-20	M	,151	,437	12,1	3 1/2	89
NP-32-TX-25	T-25	NP	,173	,437	12,1	3 3/4	95
R-32-TX-27	T-27	R	,195	,563	14,3	3 5/8	92
S-32-TX-30	T-30	S	,216	,625	15,9	3 7/8	98

*See page 14 for Sleeve Selection



7/16" Hex Power Drive

Part Number	Driver Size		Body Diameter		Overall Length	
			In.	mm	In.	mm
48-TX-40	T-40	,260	,277	7,0	3 1/2	89
48-TX-45	T-45	,306	,323	8,2	3 1/2	89
48-TX-50	T-50	,346	,363	9,2	3 1/2	89
48-TX-55	T-55	,440	,503	12,8	3 3/4	95

Torx® Bits



10-32 Screw Shank Drive

Part Number	Driver Size		Body Diameter		Overall Length	
			In.	mm	In.	mm
50-TX-08	T-8		,090	,125	3,2	1 1/2 38
50-TX-10	T-10		,107	,150	3,8	1 1/2 38
50-TX-15	T-15		,128	,150	3,8	1 1/2 38
50-TX-20	T-20		,151	,171	4,3	1 1/2 38



12-24 Screw Shank Drive

Part Number	Driver Size		Body Diameter		Overall Length	
			In.	mm	In.	mm
55-TX-10	T-10		,107	,150	3,8	1 3/16 30
55-TX-15	T-15		,128	,150	3,8	1 3/16 30
SD-4048	T-15		,128	,309	7,8	1 3/16 30
55-TX-20	T-20		,151	,171	4,3	1 3/16 30
55-TX-25	T-25		,173	,193	4,9	1 3/16 30
55-TX-30	T-30		,216	,309	7,8	1 3/16 30



Female Square Service Drive

Part Number	Driver Size		Square Drive	Body Diameter		Overall Length	
				In.	mm	In.	mm
834-TX-25	T-25		3/8	,240	6,1	2 13/16 71	
834-TX30-1,62	T-30		3/8	,234	5,9	1 5/8 41	
834-TX40-2,95	T-40		3/8	,277	7,0	2 61/64 75	
834-TX50-1,62	T-50		3/8	,373	9,4	1 1/4 41	
834-TX-45-5	T-45		3/8	,323	8,2	5 125	
834-TX-50	T-50		3/8	,363	9,2	2 5/8 66	
854-TX-50	T-50		1/2	,323	8,2	2 7/8 73	
854-TX-55-150M	T-55		1/2	,363	9,2	5 7/8 150	

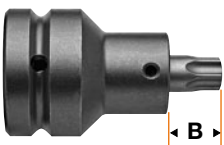

1" Square Drive Adapters with Torx® Insert Bit

Part Number	Driver Size		Overall Length		Bit Length (B)	
			In.	mm	In.	mm
SZ-8L-TX-70	T-70		,610	3 19/32 91	,90	23
SZ-TX-100	T-100		,870	3 19/32 91	1,13	29

Torx Plus® Bits



1/4" Hex Insert Bits

Part Number	Driver Size		Overall Length	
			In.	mm
440-10IPX	10IP		,107	1 25
440-15IPX	15IP		,128	1 25
440-20IPX	20IP		,151	1 25
440-25IPX	25IP		,173	1 25
440-27IPX	27IP		,195	1 25
440-30IPX	30IP		,216	1 25
440-40IPX	40IP		,260	1 25



1/4" Hex Insert Bits – Tamper Resistant**

Part Number	Driver Size		Overall Length	
			In.	mm
440-10IPRX	10IPR		,107	1 25
440-15IPRX	15IPR		,128	1 25
440-20IPRX	20IPR		,151	1 25
440-25IPRX	25IPR		,173	1 25
440-27IPRX	27IPR		,195	1 25
440-30IPRX	30IPR		,216	1 25
440-40IPRX	40IPR		,260	1 25

**Tamper resistant Torx Plus® bits are available on a restricted distribution basis. Contact your local Apex representative for details.



5/16" Hex Insert Bits

Part Number	Driver Size		Overall Length	
			In.	mm
480-30IPX	30IPR		,216	1 1/4 32
480-40IPX	40IPR		,260	1 1/4 32
480-45IPX	45IPR		,306	1 1/4 32
480-50IPX	50IPR		,346	1 1/4 32
480-55IPX	55IPR		,440	1 1/4 32

Torx Plus® Bits



1/4" Hex Power Drive

Part Number	Driver Size		Overall Length	
			In.	mm
49-10IPX	10IP	,107	1 15/16	49
49-A-10IPX	10IP	,107	2 3/4	70
49-B-10IPX	10IP	,107	3 1/2	89
49-15IPX	15IP	,128	1 15/16	49
49-A-15IPX	15IP	,128	2 3/4	70
49-B-15IPX	15IP	,128	3 1/2	89
49-20IPX	20IP	,151	1 15/16	49
49-A-20IPX	20IP	,151	2 3/4	70
49-B-20IPX	20IP	,151	3 1/2	89
49-25IPX	25IP	,173	1 15/16	49
49-A-25IPX	25IP	,173	2 3/4	70
49-B-25IPX	25IP	,173	3 1/2	89
49-27IPX	27IP	,195	1 15/16	49
49-A-27IPX	27IP	,195	2 3/4	70
49-B-27IPX	27IP	,195	3 1/2	89
49-30IPX	30IP	,216	1 15/16	49
49-A-30IPX	30IP	,216	2 3/4	70
49-B-30IPX	30IP	,216	3 1/2	89
49-40IPX	40IP	,260	1 15/16	49



1/4" Hex Power Drive - Tamper Resistant

Part Number	Driver Size		Overall Length	
			In.	mm
49-10IPRX	10IPR	,107	1 15/16	49
49-15IPRX	15IPR	,128	1 15/16	49
49-20IPRX	20IPR	,151	1 15/16	49
49-25IPRX	25IPR	,173	1 15/16	49
49-27IPRX	27IPR	,195	1 15/16	49
49-30IPRX	30IPR	,216	1 15/16	49
49-40IPRX	40IPR	,260	1 15/16	49

Pozidriv® Bits



1/4" Hex Insert Bits

Part Number	Point Size	Overall Length	
		In.	mm
440-1-PZDX	1	1	25
440-2-PZDX	2	1	25
440-215-PZDX	2	1 1/2	38
440-22-PZDX	2	2	51
440-3-PZDX	3	1	25
440-4-PZDX	4	1 1/4	32

Pozidriv® is a registered trademark of the Phillips Screw Company.

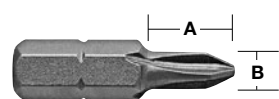

1/4" Hex Insert Bits - Limited

Part Number	Point Size	Overall Length		Turned Length (A)		Turned OD (B)	
		In.	mm	In.	mm	In.	mm
446-1-PZDX	1	1	25,4	7/16	11	0,18	4,6
446-2-PZDX	2	1	25,4	7/16	11	0,18	4,6



5/16" Hex Insert Bits

Part Number	Point Size	Overall Length	
		In.	mm
480-1-PZDX	1	1 1/4	32
480-2-PZDX	2	1 1/4	32
480-3-PZDX	3	1 1/4	32

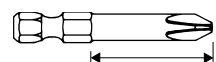

1/4" Hex Power Drive

Part Number	Point Size	Overall Length		Body Diameter		Turned Length	
		In.	mm	In.	mm	In.	mm
491-PZDX	1	1 15/16	49	3/16	4,8	1 1/4	32
491-A-PZDX	1	2 3/4	70	3/16	4,8	2	51
491-B-PZDX	1	3 1/2	89	3/16	4,8	2 3/4	70
491-C-PZDX	1	6	152	3/16	4,8	2	51
492-PZDX	2	1 15/16	49	1/4	6,4	1 1/4	32
492-A-PZDX	2	2 3/4	70	1/4	6,4	2	51
492-B-PZDX	2	3 1/2	89	1/4	6,4	2 3/4	70
492-C-PZDX	2	6	152	1/4	6,4	2	51
493-PZDX	3	1 15/16	49	5/16	7,9	1	25
493-A-PZDX	3	2 3/4	70	5/16	7,9	1 3/4	44
493-B-PZDX	3	3 1/2	89	5/16	7,9	2 1/4	57
493-C-PZDX	3	6	152	5/16	7,9	5	127



1/4"-24 Screw Shank Drive

Part Number	Point Size	Overall Length		Body Diameter	
		In.	mm	In.	mm
401-PZDX	1	1 1/2	38	3/16	4,8
402-PZDX	2	1 1/2	38	1/4	6,4
403-PZDX	3	1 1/2	38	5/16	7,9



8-32 Screw Shank Drive

Part Number	Point Size	Overall Length		Body Diameter	
		In.	mm	In.	mm
401-PZDX	1	1 1/2	38	3/16	4,8
402-PZDX	2	1 1/2	38	1/4	6,4
403-PZDX	3	1 1/2	38	5/16	7,9
591-PZDX	1	1 3/16	30	7/32	5,6
592-PZDX	2	1 3/16	30	7/32	5,6



10-32 Screw Shank Drive

Part Number	Point Size	Overall Length		Body Diameter	
		In.	mm	In.	mm
401-PZDX	1	1 1/2	38	3/16	4,8
402-PZDX	2	1 1/2	38	1/4	6,4
403-PZDX	3	1 1/2	38	5/16	7,9
502-PZDX	2	1 1/2	38	1/4	6,4
SD-1342-2-PZD	2	1 3/4	45	1/4	6,4

Sel-O-Fit Bits



1/4" Hex Insert Bits

Part Number	Point Size	Overall Length	
		In.	mm
440-1-SFX	1	1	25
440-2-SFX	2	1	25
440-215-SFX	2	1 1/2	38
440-22-SFX	2	2	51
440-225-SFX	2	2 1/2	64
440-3-SFX	3	1	25



1/4" Hex Insert Bits – Limited Clearance

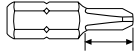

Part Number	Point Size	Overall Length		Turned Length (A)		Turned OD (B)	
		In.	mm	In.	mm	In.	mm
446-2-SFX	2	1	25	7/16	11	0,18	4,6

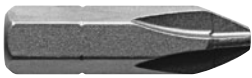

5/16" Hex Insert Bits

Part Number	Point Size	Overall Length	
		In.	mm
480-2-SFX	2	1 1/4	32



1/4" Hex Power Drive

Part Number	Point Size	Overall Length		Shank Diameter		Turned Length	
		In.	mm	In.	mm	In.	mm
491-SFX	1	1 15/16	49	3/16	5	1 1/4	32
491-A-SFX	1	2 3/4	70	3/16	5	2	51
491-B-SFX	1	3 1/2	89	3/16	5	2 3/4	70
491-C-SFX	1	6	152	3/16	5	2	51
492-SFX	2	1 15/16	49	1/4	6	1 1/4	32
492-A-SFX	2	2 3/4	70	1/4	6	2	51
492-B-SFX	2	3 1/2	89	1/4	6	2 3/4	70
492-C-SFX	2	6	152	1/4	6	2	51

Sel-O-Fit® bits are designed to provide a more efficient means of driving Pozidriv® screws. The Sel-O-Fit bit places torque on the strongest and most mechanically advantageous portion of the driver tip. This allows more torque to be applied while minimizing the possibility of breakage and camout. Sel-O-Fit® is a registered trademark of Cooper Industries.

Quadrex® Bits

1/4" Hex Insert Bits

Part Number	Point Size	Overall Length	
		In.	mm
950-QD-2	2	1	25

1/4" Hex Power Drive

Part Number	Point Size	Overall Length		Body Diameter	Turned Length		
		In.	mm				
95-QD-2	2	1 15/16	49	1/4	6	1 1/4	32
95-A-QD-2	2	2 3/4	70	1/4	6	2	51
95-B-QD-2	2	3 1/2	89	1/4	6	2 3/4	70
95-QD-3	3	1 15/16	49	5/16	7,9	1 1/4	32

If the tool you need does not appear in this catalog, give us a call. The odds are, we may have what you need as a non-catalog item. If not, our experienced staff of tooling experts can design and manufacture "specials" to meet the needs of your specific application.

Give us a call at +49 7363-81-129 or visit our website www.apexpowertools.eu.

Frearson Bits (+)

1/4" Hex Insert Bits



Part Number	Point Size	Overall Length	
		In.	mm
440-FX	alle	1	25
446-FX	alle	1	25

For limited clearance

5/16" Hex Insert Bit



Part Number	Size	Overall Length	
		In.	mm
480-FX	alle	1 3/8	35



1/4" Hex Power Drive

Part Number	Point Size	Overall Length		Body Diameter		Turned Length	
		In.	mm	In.	mm	In.	mm
491-FX	alle	1 15/16	49	3/16	5	1 1/4	32
491-AFX	alle	2 3/4	70	3/16	5	2	51
491-BFX	alle	3 1/2	89	3/16	5	2 3/4	70
491-CFX	alle	6	152	3/16	5	2	51
492-FX	alle	1 15/16	49	1/4	6	1 1/4	32
492-AFX	alle	2 3/4	70	1/4	6	2	51
492-BFX	alle	3 1/2	89	1/4	6	2 3/4	70
492-CFX	alle	6	152	1/4	6	2	51
493-FX	alle	1 15/16	49	5/16	8	1	25
493-BFX	alle	3 1/2	89	5/16	8	2 1/2	64

The Frearson recess is designed so that any size bit will fit any size recess. Choose bits on the basis of body diameter – the larger the screw, the larger the body diameter.

12-24 Screw Shank Drive



Part Number	Screw Size	Overall Length		Body Diameter	
		In.	mm	In.	mm
552-FX	alle	1 3/16	30	.30	8



1/4" Female Square Drive

Part Number	Screw Size	Overall Length		Body Diameter	
		In.	mm	In.	mm
822-F	alle	2	51	1/4	6



3/8" Female Square Drive

Part Number	Screw Size	Overall Length		Body Diameter	
		In.	mm	In.	mm
832-F	alle	2 5/8	67	1/4	6
833-F	alle	2 5/8	67	5/16	8
834-F	alle	2 5/8	67	3/8	10

B.N.A.E. Bits (+)

1/4" Hex Insert Bits



Part Number	Point Size	Overall Length	
		In.	mm
BNAE-3mm	3mm	1 1/8	29
BNAE-4mm	4mm	1 1/8	29
BNAE-5mm	5mm	1 1/8	29
BNAE-6mm	6mm	1 1/8	29
BNAE-8mm	8mm	1 1/8	29

1/4" Hex Insert Bits – ACR®



Part Number	Point Size	Overall Length	
		In.	mm
BNAE-4mm-ACR	4mm	1 1/8	29
BNAE-5mm-ACR	5mm	1 1/8	29
BNAE-6mm-ACR	6mm	1 1/8	29



ACR® ribs for both removal and driving

Socket Head Sizing Chart

SAE



Nominal Hex Size Inches	Socket Head 1960 Series	Cap Screws 1936 Series	Flat Head Cap Screws	Button Head Cap Screws	Set Screws	Shoulder Screws	Pressure Plugs	Allenuts	Low Head Cap Screws
.050	0	0, 1	1, 2	3, 4	—	—	—	4	.050
1/16	1	2	3, 4	3, 4	5, 6	—	—	—	5, 6
5/64	2, 3	3, 4	5, 6	5, 6	8	—	—	—	8
3/32	4, 5	5, 6	8	8	10	—	—	—	10
7/64	6	—	—	—	—	—	—	—	—
1/8	8	10	10	1/4	1/4	—	4, 5	1/4	—
9/64	8	10	—	—	—	—	—	—	—
5/32	10	1/4	1/4	1/4	5/16	5/16	1/16	6	5/16
3/16	1/4	—	5/16	5/16	3/8	3/8	1/8	8, 10	3/8
7/32	—	5/16	3/8	3/8	7/16	—	—	—	7/16
1/4	5/16	—	7/16	—	1/2	1/2	1/4	1/4	1/2
5/16	3/8	3/8, 7/16	1/2	—	5/8	5/8	3/8	5/16	5/8
3/8	7/16, 1/2	1/2	5/8	—	3/4	3/4	1/2	3/8	—
7/16	—	—	—	—	—	—	—	7/16	—
1/2	5/8	5/8	3/4	—	7/8	1	—	1/2	—
9/16	—	3/4, 7/8	7/8	—	1, 1 1/8	—	3/4	—	—
5/8	3/4	1	1	—	1 1/4, 1 3/8	1 1/4	1	5/8	—
3/4	7/8, 1	1 1/8, 1 1/4, 1 3/8	1 1/8	—	1 1/2	—	1 1/4	3/4	—
7/8	1 1/8, 1 1/4	—	1 1/4, 1 3/8	—	—	1 1/2	—	7/8	—
1	1 3/8, 1 1/2	1 1/2	1 1/2	—	1 3/4, 2	1 3/4	1 1/2, 2	1	—
1 1/4	1 3/4	—	—	—	—	2	—	1 1/4	—
1 1/2	2	—	—	—	—	—	—	1 1/2	—
1 3/4	2 1/4, 2 1/2	—	—	—	—	—	—	—	1 3/4
2	3/4	—	—	—	—	—	—	—	—

Metric



Nominal Hex Size MM	Socket Head Cap Screws	Flat Head Cap Screws	Button Head Cap Screws	Set Screws	Shoulder Screws	Allenuts	Low Head Cap Screws
1.5	M1.6, M1.7, M2	—	—	M3	—	—	—
2	M2.3, M2.5, M2.6	M3	M3	M4	—	—	—
2.5	M3	M4	M4	M5	—	—	—
3	M4	M5	M5	M6	6mm	M3	M4
4	M5	M6	M6	M8	8mm	M4	M5
5	M6	M8	M8	M10	10mm	M5	M6
6	M8	M10	M10	M12, M14	12mm	M6	M8
8	M10	M12	M12	M16	16mm	M8	M10
10	M12	M14, M16	—	M20	20mm	M10	M12
12	M14	M20	—	M24	—	M12	M14
14	M16	—	—	—	—	—	M16
17	M20	—	—	—	—	M16	M20, M22
19	M24	—	—	—	—	—	M24

Socket Head Bits



1/4" Hex Insert Bits



Part Number	Hex Size	Overall Length	
		In.	mm
185-000X	.050	1	25
185-00X	1/16	1	25
185-0X	5/64	1	25
185-1X	3/32	1	25
185-9X	7/64	1	25
185-2X	1/8	1	25
185-10X	9/64	1	25
185-3X	5/32	1 5/16	33
185-4X	3/16	1 5/16	33
185-4-4X	3/16	4	102
185-5X	7/32	1 5/16	33
185-6X	1/4	1 5/16	33
185-7X	5/16	1 1/4	32
185-8X	3/8	1 1/4	32

1/4" Hex Insert Bits – Metric



Part Number	Hex Size	Overall Length	
		In.	mm
185-1.5MM	1.5mm	1	25
185-2MM	2mm	1	25
185-2.5MM	2.5mm	1	25
185-3MM	3mm	1	25
185-4MM	4mm	1 5/16	33
185-5MM	5mm	1 5/16	33
185-6MM	6mm	1 5/16	33
185-7MM	7mm	1 1/4	32
185-8MM	8mm	1 1/4	32
185-9MM	9mm	1 1/4	32
185-10MM	10mm	1 1/4	32

5/16" Hex Insert Bits



Part Number	Hex Size	Overall Length	
		In.	mm
315-3X	5/32	1 5/16	33
315-4X	3/16	1 5/16	33
315-5X	7/32	1 5/16	33
315-6X	1/4	1 5/16	33
315-7X	5/16	1 5/16	33
315-8X	3/8	1 5/16	33

5/16" Hex Insert Bits – Metric



Part Number	Hex Size	Overall Length	
		In.	mm
315-2.5MM	2.5mm	1	25
315-4MM	4mm	1 5/16	33
315-5MM	5mm	1 5/16	33
315-6MM	6mm	1 5/16	33
315-7MM	7mm	1 5/16	33
315-8MM	8mm	1 5/16	33
315-10MM	10mm	1 3/8	35
315-12MM	12mm	1 1/4	32
315-14MM	14mm	1 1/4	32

1/4" Hex Power Drive



Part Number	Hex Size	Overall Length	
		In.	mm
AM-01-A	0.050	1 15/16	49
AM-02	1/16	1 15/16	49
AM-02-A	5/64	1 15/16	49
AM-03	3/32	1 15/16	49
AM-03-3	3/32	3	76
AM-03-6	3/32	6	152
AM-03-A	7/64	1 15/16	49
AM-04	1/8	1 15/16	49
AM-04-3	1/8	3	76
AM-04-35	1/8	3 1/2	89
AM-04-4	1/8	4	102
AM-04-5	1/8	5	127
AM-04-6	1/8	6	152
AM-04-A	9/64	1 15/16	49
AM-04-A-4	9/64	4	102
AM-05	5/32	1 15/16	49
AM-05-3	5/32	3	76
AM-05-35	5/32	3 1/2	89
AM-05-4	5/32	4	102
AM-05-5	5/32	5	127
AM-05-6	5/32	6	152
AM-05-8	5/32	8	203
AM-06	3/16	1 15/16	49
AM-06-3	3/16	3	76
AM-06-4	3/16	4	102
AM-06-6	3/16	6	152
AM-07	7/32	1 15/16	49
AM-08	1/4	1 15/16	49
AM-10	5/16	1 15/16	49

1/4" Hex Power Drive – Metric



Part Number	Hex Size	Overall Length	
		In.	mm
AM-1.5MM	1.5mm	1 15/16	49
AM-2MM	2mm	1 15/16	49
AM-2.5MM	2.5mm	1 15/16	49
AM-3MM	3mm	1 15/16	49
AM-3MM-3	3mm	3	76
AM-3MM-4	3mm	4	102
AM-4MM	4mm	1 15/16	49
AM-5MM	5mm	1 15/16	49
AM-5MM-4	5mm	4	102
AM-6MM	6mm	1 15/16	49
AM-6MM-4	6mm	4	102
AM-7MM	7mm	1 15/16	49
AM-8MM	8mm	1 15/16	49
AM-10MM	10mm	1 15/16	49

5/16" Hex Power Drive



Part Number	Hex Size	Overall Length	
		In.	mm
AS-06	3/16	3	76
AS-10	5/16	3	76
AS-12	3/8	3	76

Socket Head Bits



7/16" Hex Power Drive



Part Number	Hex Size	Overall Length	
		In.	mm
AN-04	1/8	3 1/2	89
AN-04-A	9/64	3 1/2	89
AN-05	5/32	3 1/2	89
AN-05-6	5/32	6	152
AN-06	3/16	3 1/2	89
AN-06-6	3/16	6	152
AN-07	7/32	3 1/2	89
AN-07-8	7/32	8	203
AN-08	1/4	3 1/2	89
AN-08-8	1/4	8	203
AN-09	9/32	3 1/2	89
AN-10	5/16	3 1/2	89
AN-10-6	5/16	6	152
AN-12	3/8	3 1/2	89
AN-12-6	3/8	6	152
AN-16	1/2	3 1/2	89
AN-16-6	1/2	6	152

7/16" Hex Power Drive, Metric



Part Number	Hex Size	Overall Length	
		In.	mm
AN-3MM	3mm	3 1/2	89
AN-4MM	4mm	3 1/2	89
AN-5MM	5mm	3 1/2	89
AN-6MM	6mm	3 1/2	89
AN-8MM	8mm	3 1/2	89
AN-10MM	10mm	3 1/2	89
AN-12MM	12mm	3 1/2	89
AN-14MM	14mm	3 1/2	89
AN-14MM-6	14mm	6	152

5/8" Hex Power Drive



Part Number	Hex Size	Overall Length	
		In.	mm
AP-08	1/4	4	102
AP-10	5/16	4	102
AP-12	3/8	4	102
AP-16	1/2	4	102
AP-18	9/16	4	102
AP-20	5/8	4	102
AP-24	3/4	4	102

Socket Head Bits with Square Drive Adapters, SAE



3/8" Square Drive



Complete	Part Number		Hex Size	Overall Length		Length of Insert	
	Adapter Only	Insert Only		In.	mm	In.	mm
SZ-9	SC-314	SZ-9-A	3/32	2 1/4	57	1 3/8	35
SZ-7	SC-314	SZ-7-A	7/64	2 1/4	57	1 3/8	35
SZ-10	SC-314	SZ-10-A	1/8	2 1/4	57	1 3/8	35
SZ-11	SC-314	SZ-11-A	5/32	2 1/4	57	1 3/8	35
SZ-12	SC-314	SZ-12-A	3/16	2 1/4	57	1 3/8	35
SZ-13	SC-314	SZ-13-A	7/32	2 1/4	57	1 3/8	35
SZ-14	SC-314	SZ-14-A	1/4	2 1/4	57	1 3/8	35
SZ-15	SC-314	SZ-15-A	5/16	2 1/4	57	1 3/8	35
SZ-16	SC-314	SZ-16-A	3/8	2 1/4	57	1 3/8	35
SZ-17	SC-314	SZ-17-A	1/2	2 1/4	57	1 3/8	35
SZ-18	SC-314	SZ-18-A	9/16	2 1/4	57	1 3/8	35
SZ-19	SC-314	SZ-19-A	5/8	2 1/4	57	1 3/8	35

1/2" Square Drive



Complete	Part Number		Hex Size	Overall Length		Length of Insert	
	Adapter Only	Insert Only		In.	mm	In.	mm
SZ-41	SC-514	SZ-11-A	5/32	2 1/2	64	1 3/8	35
SZ-20	SC-514	SZ-12-A	3/16	2 1/2	64	1 3/8	35
SZ-21	SC-514	SZ-13-A	7/32	2 1/2	64	1 3/8	35
SZ-22	SC-514	SZ-14-A	1/4	2 1/2	64	1 3/8	35
SZ-23	SC-514	SZ-15-A	5/16	2 1/2	64	1 3/8	35
SZ-24	SC-514	SZ-16-A	3/8	2 1/2	64	1 3/8	35
SZ-25	SC-514	SZ-17-A	1/2	2 1/2	64	1 3/8	35
SZ-42	SC-520	SZ-31-A	1/2	2 1/2	64	1 9/16	40
SZ-43	SC-514	SZ-18-A	9/16	2 1/2	64	1 3/8	35
SZ-44	SC-520	SZ-32-A	9/16	2 1/2	64	1 9/16	40
SZ-26	SC-514	SZ-19-A	5/8	2 1/2	64	1 3/8	35
SZ-27	RP-520	SZ-33-A	5/8	2 1/2	64	1 9/16	40

Adapters with an "SC" prefix feature a set screw for locking in the bit. An "RP" prefix indicates adapters with a thru hole for a spring pin.

7/16" Hex Insert Bit Only



Part Number	Hex Size	Overall Length	
		In.	mm
SZ-11-A-3	5/32	3	76
SZ-12-A-2	3/16	2	51
SZ-12-A-3	3/16	3	76
SZ-12-A-6	3/16	6	152
SZ-13-A-3	7/32	3	76
SZ-14-A-3	1/4	3	76
SZ-14-A-4	1/4	4	102
SZ-15-A-2	5/16	2	51
SZ-15-A-3	5/16	3	76
SZ-15-A-4	5/16	4	102
SZ-16-A-3	3/8	3	76
SZ-16-A-4	3/8	4	102

Use 7/16" Hex Insert Bits with 7/16" Female Hex Square drive adapters, page 26. These bits feature a thru hole on the hex flat for use with a spring pin.

Socket Head Bits with Square Drive Adapters, SAE



3/4" Square Drive

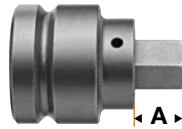

Complete	Part Number		Hex Size	Overall Length		Length of Insert		Bit Length (A)	
	Adapter Only	Insert Only		In.	mm	In.	mm	In.	mm
SZ-30	SC-720	SZ-30-A	3/8	2 5/8	67	1 9/16	40	29/32	23
SZ-31	SC-720	SZ-31-A	1/2	2 5/8	67	1 9/16	40	29/32	23
SZ-32	SC-720	SZ-32-A	9/16	2 5/8	67	1 9/16	40	29/32	23
SZ-33	RP-720	SZ-33-A	5/8	2 5/8	67	1 9/16	40	29/32	23
SZ-34	RP-720	SZ-34-A	3/4	2 5/8	67	1 9/16	40	29/32	23
SZ-37	RP-728	SZ-37-A	3/4	3 1/8	79	2	51	1 1/8	29
SZ-35	SC-720	SZ-35-A	7/8	2 5/8	67	1 9/16	40	29/32	23
SZ-38	RP-728	SZ-38-A	7/8	3 1/8	79	2	51	1 1/8	29
SZ-36	RP-720	SZ-36-A	1	2 5/8	67	1 9/16	40	29/32	23

1" Square Drive



Complete	Part Number		Hex Size	Overall Length		Length of Insert		Bit Length (A)	
	Adapter Only	Insert Only		In.	mm	In.	mm	In.	mm
SZ-80	RP-820	SZ-31-A	1/2	3 1/16	78	1 9/16	40	29/32	23
SZ-85	RP-828	SZ-85-A	5/8	3 1/4	83	2	51	1 1/8	29
SZ-86	RP-820	SZ-34-A	3/4	3 1/32	77	1 9/16	40	29/32	23
SZ-87	RP-828	SZ-37-A	3/4	3 1/4	83	2	51	1 1/8	29
SZ-88	SC-820	SZ-35-A	7/8	3 1/16	78	1 9/16	40	29/32	23
SZ-89	RP-828	SZ-38-A	7/8	3 1/4	83	2	51	1 1/8	29
SZ-91	RP-828	SZ-39-A	1	3 1/4	83	2	51	1 1/8	29
SZ-101	RP-848	SZ-101-A	1 1/4	3 1/2	89	2 5/8	67	1 3/8	35

An "RP" prefix indicates adapters with a roll pin that is inserted through the bit.

Socket Head Bit & Adapter Sets, SAE



- APH38 8 piece, 3/8" square drive:
1/8, 9/64, 5/32, 3/16, 7/32, 1/4, 5/16, 3/8
- APH56 6 pieces, 1/2" square drive:
1/4, 5/16, 3/8, 1/2, 9/16, 5/8

Socket Head Bit & Adapter Sets, Metric



- APH35M 5 piece, 3/8" square drive:
4mm, 5mm, 6mm, 8mm, 10mm
- APH56M 6 piece, 1/2" square drive:
6mm, 8mm, 10mm, 12mm, 14mm, 17mm

Socket Head Adapters & Inserts, Metric



3/8" Square Drive

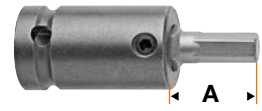

Complete	Part Number		Hex Size	Overall Length		Length of Insert		Bit Length (A)	
	Adapter Only	Insert Only		In.	mm	In.	mm	In.	mm
SZ-3-7-4MM	SC-314	SZ-7-4MM	4mm	2 1/4	57	1 3/8	35	7/8	22
SZ-3-7-5MM	SC-314	SZ-7-5MM	5mm	2 1/4	57	1 3/8	35	7/8	22
SZ-3-7-6MM	SC-314	SZ-7-6MM	6mm	2 1/4	57	1 3/8	35	7/8	22
SZ-3-7-8MM	SC-314	SZ-7-8MM	8mm	2 1/4	57	1 3/8	35	7/8	22
SZ-3-7-10MM	SC-314	SZ-7-10MM	10mm	2 1/4	57	1 3/8	35	7/8	22

1/2" Square Drive

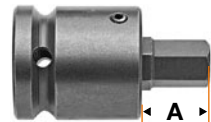

Complete	Part Number		Hex Size	Overall Length		Length of Insert		Bit Length (A)	
	Adapter Only	Insert Only		In.	mm	In.	mm	In.	mm
SZ-5-7-4MM	SC-514	SZ-7-4MM	4mm	2 1/2	63	1 3/8	35	7/8	22
SZ-5-7-5MM	SC-514	SZ-7-5MM	5mm	2 1/2	63	1 3/8	35	7/8	22
SZ-5-7-6MM	SC-514	SZ-7-6MM	6mm	2 1/2	63	1 3/8	35	7/8	22
SZ-5-7-8MM	SC-514	SZ-7-8MM	8mm	2 1/2	63	1 3/8	35	7/8	22
SZ-5-7-10MM	SC-514	SZ-7-10MM	10mm	2 1/2	63	1 3/8	35	7/8	22
SZ-5-7-12MM	SC-514	SZ-7-12MM	12mm	2 1/2	63	1 3/8	35	7/8	22
SZ-5-7-14MM	SC-514	SZ-7-14MM	14mm	2 1/2	63	1 3/8	35	15/16	24
SZ-5-10-14MM	RP-520	SZ-10-14MM	14mm	2 1/2	63	1 9/16	40	29/32	23
SZ-5-10-17MM	RP-520	SZ-10-17MM	17mm	2 1/2	63	1 9/16	40	29/32	23
SZ-5-10-19MM	RP-520	SZ-10-19MM	19mm	2 1/2	63	1 9/16	40	29/32	23

3/4" Square Drive



Complete	Part Number		Hex Size	Overall Length		Length of Insert		Bit Length (A)	
	Adapter Only	Insert Only		In.	mm	In.	mm	In.	mm
SZ-7-10-10MM	RP-720	SZ-10-10MM	10mm	2 1/2	64	1 9/16	40	29/32	23
SZ-7-10-12MM	RP-720	SZ-10-12MM	12mm	2 1/2	64	1 9/16	40	29/32	23
SZ-7-10-14MM	RP-720	SZ-10-14MM	14mm	2 1/2	64	1 9/16	40	29/32	23
SZ-7-10-17MM	RP-720	SZ-10-17MM	17mm	2 1/2	64	1 9/16	40	29/32	23

1" Square Drive



Complete	Part Number		Hex Size	Overall Length		Length of Insert		Bit Length (A)	
	Adapter Only	Insert Only		In.	mm	In.	mm	In.	mm
SZ-8-14-17MM	RP-828	SZ-14-17MM	17mm	3 5/16	84	2	51	1 1/8	29
SZ-8-14-19MM	RP-828	SZ-14-19MM	19mm	3 5/16	84	2	51	1 1/8	29
SZ-8-14-22MM	RP-828	SZ-14-22MM	22mm	3 5/16	84	2	51	1 1/8	29
SZ-8-14-24MM	RP-828	SZ-14-24MM	24mm	3 5/16	84	2	51	1 1/8	29
SZ-8-14-27MM	RP-828	SZ-14-27MM	27mm	3 5/16	84	2	51	1 1/8	29

Square Recess Bits

1/4" Hex Insert Bits



Part Number	Point Size	Nominal Size In.	Overall Length In.	Overall Length mm
950-0X	0	1/16	1	25
950-1X	1	3/32	1	25
950-2X	2	1/8	1	25
950-3X	3	9/64	1	25

1/4" Hex Power Drive



Part Number	Point Size	Nominal Size In.	Overall Length In.	Overall Length mm
954-0X	0	1/16	1 15/16	49
954-A-0X	0	1/16	2 3/4	70
954-C-0X	0	1/16	6	152
954-1X	1	3/32	1 15/16	49
954-A-1X	1	3/32	2 3/4	70
954-B-1X	1	3/32	3 1/2	89
954-C-1X	1	3/32	6	152
954-2X	2	1/8	1 15/16	49
954-A-2X	2	1/8	2 3/4	70
954-B-2X	2	1/8	3 1/2	89
954-C-2X	2	1/8	6	152
954-3X	3	9/64	1 15/16	49
954-A-3X	3	9/64	2 3/4	70
954-B-3X	3	9/64	3 1/2	89
954-C-3X	3	9/64	6	152

1/4" Hex Power Drive – Turned Body



Part Number	Point Size	Nominal Size In.	Overall Length In.	Overall Length mm	Turned Diameter In.	Turned Diameter mm
1950-0X	0	1/16	1 15/16	49	1 1/4	32
1951-0X	0	1/16	2 3/4	70	2	51
1950-1X	1	3/32	1 15/16	49	1 1/4	32
1951-1X	1	3/32	2 3/4	70	2	51
1953-1X	1	3/32	3 1/2	89	2 3/4	70
1950-2X	2	1/8	1 15/16	49	1 1/4	32
1951-2X	2	1/8	2 3/4	70	2	51
1953-2X	2	1/8	3 1/2	89	2 3/4	70
1956-2X	2	1/8	6	152	5 1/8	130
1950-3X	3	9/64	1 15/16	49	1 1/4	32
1951-3X	3	9/64	2 3/4	70	2	51
1953-3X	3	9/64	3 1/2	89	2 3/4	70
Screw size		3 & 4	5, 6, 7	8, 9, 10	12-14	1/4
Square Point Size		0	1	2		3

For Quad-rex bits refer to page 14.

Male Square Inserts for Pipe Plugs

1/4" to 1/2" Male Square



Part Number	Male Hex In.	Male Square In.	Overall Length In.	Overall Length mm
P-1408	7/16	1/4	1 1/4	32
P-1409	7/16	9/32	1 1/4	32
P-1410	7/16	5/16	1 1/4	32
P-1412	7/16	3/8	1 1/4	32
P-1414	7/16	7/16	1 1/4	32
P-1416	7/16	1/2	1 1/4	32
P-2010	5/8	5/16	1 1/2	38
P-2012	5/8	3/8	1 1/2	38
P-2014	5/8	7/16	1 1/2	38
P-2016	5/8	1/2	1 1/2	38

Note: For pipe plug inserts use SC and RP bit holders found on page 26.

Triple Square Bits

1/4" Hex Insert Bits

Part Number	Point Size	Overall Length	
		In.	mm
440-TSQ-4M	4mm	1	25
440-TSQ-5M	5mm	1	25
440-TSQ-6M	6mm	1	25
440-TSQ-8M	8mm	1	25
440-TSQ-10M	10mm	1	25

5/16" Hex Insert Bits

Part Number	Point Size	Overall Length	
		In.	mm
480-TSQ-6M	6mm	1 1/4	32
480-TSQ-8M	8mm	1 1/4	32
480-TSQ-10M	10mm	1 1/4	32
480-TSQ-12M	12mm	1 1/4	32
480-TSQ-14M	14mm	1 1/4	32

1/4" Hex Power Drive

Part Number	Point Size	Overall Length	
		In.	mm
49-TSQ-4M	4mm	2	50
49-TSQ-5M	5mm	2	50
49-TSQ-6M	6mm	2	50
49-TSQ-8M	8mm	2	50
49-TSQ-10M	10mm	2	50
49-TSQ-12M	12mm	2	50

7/16" Hex Power Drive

Part Number	Point Size	Overall Length	
		In.	mm
48-TSQ-5M	5mm	3 1/2	88
48-TSQ-6M	6mm	3 1/2	88
48-TSQ-8M	8mm	3 1/2	88
48-TSQ-10M	10mm	3 1/2	88
48-TSQ-12M	12mm	3 1/2	88
48-TSQ-14M	14mm	3 1/2	88

Torq-Set® Bits

1/4" Hex Insert Bits

Part Number	Point Size	Overall Length	
		In.	mm
212-0	0	1	25
212-1	1	1	25
212-2	2	1	25
212-3	3	1	25
212-4	4	1	25
212-5	5	1	25
212-6	6	1	25
212-8	8	1	25
212-10	10	1	25
212-1/4	1/4	1	25

1/4" Hex Insert Bits – ACR®

Available with ACR® ribs for removal only

Part Number	Point Size	Overall Length	
		In.	mm
212-6-ACR	6	1 1/4	32
212-8-ACR	8	1 1/4	32
212-10-ACR	10	1 1/4	32
212-1/4-ACR	1/4	1 1/4	32

5/16" Hex Insert Bits

Part Number	Point Size	Overall Length	
		In.	mm
212-8A	8	1 1/4	32
212-10A	10	1 1/4	32
212-1/4A	1/4	1 1/4	32
212-5/16A	5/16	1 1/4	32
212-3/8A	3/8	1 1/4	32

5/16" Hex Insert Bits – ACR®

Available with ACR® ribs for removal only

Part Number	Point Size	Overall Length	
		In.	mm
212-1/4A-ACR	1/4	1 1/4	32
212-5/16A-ACR	5/16	1 1/4	32

Torq-Set® Bits

1/4" Hex Power Drive



Part Number	Point Size	Overall Length	
		In.	mm
170-0	0	1 1/4	32
273-0	0	1 15/16	49
273B-0	0	2 3/4	70
265-0	0	3 1/2	89
265A-0	0	6	152
170-1	1	1 1/4	32
273A-1	1	1 13/16	46
273-1	1	1 15/16	49
273B-1	1	2 3/4	70
265-1	1	3 1/2	89
265A-1	1	6	152
170-2	2	1 1/4	32
273A-2	2	1 13/16	46
273-2	2	1 15/16	49
273B-2	2	2 3/4	70
265-2	2	3 1/2	89
265A-2	2	6	152
170-3	3	1 1/4	32
273A-3	3	1 13/16	46
273-3	3	1 15/16	49
273B-3	3	2 3/4	70
265-3	3	3 1/2	89
265A-3	3	6	152
170-4	4	1 1/4	32
273A-4	4	1 13/16	46
273-4	4	1 15/16	49
273B-4	4	2 3/4	70
265-4	4	3 1/2	89
265A-4	4	6	152
170-5	5	1 1/4	32
273-5	5	1 15/16	49
273B-5	5	2 3/4	70
265-5	5	3 1/2	89
265A-5	5	6	152
170-6	6	1 1/4	32
170-6-ACR*	6	1 1/4	32
273A-6	6	1 13/16	46
273-6	6	1 15/16	49
273B-6	6	2 3/4	70
265-6	6	3 1/2	89
265A-6	6	6	152
170-8	8	1 1/4	32
170-8-ACR*	8	1 1/4	32
273A-8	8	1 13/16	46
273-8	8	1 15/16	49
273B-8	8	2 3/4	70
265-8	8	3 1/2	89
265A-8	8	6	152
170-10	10	1 1/4	32
170-10-ACR*	10	1 1/4	32
273A-10	10	1 13/16	46
273-10	10	1 15/16	49
273B-10	10	2 3/4	70
265-10	10	3 1/2	89
265A-10	10	6	152
170-1/4B	1/4	1 1/4	32
170-5/16B	5/16	1 1/4	32
170-3/8B	3/8	1 1/4	32

*Feature ACR® anti-camout ribs.

5/16" Hex Power Drive



Part Number	Point Size	Overall Length	
		In.	mm
170-8A	8	1 1/4	32
170-10A	10	1 1/4	32
170-1/4A	1/4	1 1/4	32
170-5/16A	5/16	1 1/4	32
170-3/8A	3/8	1 1/4	32

7/16" Hex Power Drive



Part Number	Point Size	Overall Length	
		In.	mm
170-1/4	1/4	1 1/4	32
265-1/4	1/4	3 1/2	89
265A-1/4	1/4	6	152
170-5/16	5/16	1 1/4	32
265-5/16	5/16	3 1/2	89
265A-5/16	5/16	6	152
170-3/8	3/8	1 1/4	32
170-3/8C	3/8	1 1/4	32
265A-3/8	3/8	6	152
170-7/16	7/16	1 1/4	32
170-7/16C	7/16	1 1/4	32
265A-7/16	7/16	6	152

7/16" Hex Power Drive – ACR®

Available with ACR® ribs for removal only



Part Number	Point Size	Overall Length	
		In.	mm
170-1/4-ACR	1/4	1 1/4	32
170-5/16-ACR	5/16	1 1/4	32

5/8" Hex Power Drive



Part Number	Point Size	Overall Length	
		In.	mm
170-1/2	1/2	1 1/4	32
170-9/16	9/16	1 1/4	32
170-5/8	5/8	1 1/4	32

MorTorq® Bits



Part Number	Driver Size/Type	MorTorq Size	Overall Length	
			In.	mm
440-MT-00	1/4" Hex Insert	00	1	25
440-MT-0	1/4" Hex Insert	0	1	25
440-MT-1	1/4" Hex Insert	1	1	25
440-MT-2	1/4" Hex Insert	2	1	25
480-MT-3	5/16" Hex Insert	3	1 1/4	31
AM-MT-0	1/4" Hex Power	0	1 15/16	31
AM-MT-1	1/4" Hex Power	1	1 15/16	31
AM-MT-2	1/4" Hex Power	2	1 15/16	31
AN-MT-3	7/16" Hex Power	3	3 1/2	89
AN-MT-4	7/16" Hex Power	4	3 1/2	89

Other drive sizes/Types and point sizes can be quoted. Contact your Apex Distributor or Representative for more information. MorTorq® is a registered trademark of Phillips Screw Company.

Torq-Set®, ACR® and Tri-Wing® are registered trademarks of the Phillips Screw Company.

Tri-Wing®

1/4" Hex Insert Bits



Part Number	Recess Size	Screw Size Tension Head	Screw Size Shear Head	Overall Length In.	Overall Length mm
TWD-0	0	0-80	-	1	25
TWD-1	1	2-56	4-40	1	25
TWD-2	2	4-40	6-32	1	25
TWD-3	3	6-32	8-32	1	25
TWD-4	4	8-32	10-32	1	25
TWD-5	5	10-32	1/4-28	1	25
TWD-6	6	1/4	5/16	1	25
TWD-7	7	5/16	3/8	1	25

1/4" Hex Insert Bits – ACR®

Available with ACR® ribs for removal only



Part Number	Recess Size	Screw Size Tension Head	Screw Size Shear Head	Overall Length In.	Overall Length mm
TWD-4-ACR	4	8-32	10-32	1	25
TWD-5-ACR	5	10-32	1/4-28	1	25

5/16" Hex Insert Bit



Part Number	Recess Size	Screw Size Tension Head	Screw Size Shear Head	Overall Length In.	Overall Length mm
TWE-4	4	8-32	10-32	1 1/4	32
TWE-5	5	10-32	1/4-28	1 1/4	32

1/4" Hex Power Drive



Part Number	Recess Size	Screw Size Tension Head	Screw Size Shear Head	Overall Length In.	Overall Length mm
TW-0	0	0-80	-	1 1/4	32
TW-1	1	2-56	4-40	1 1/4	32
TW-2	2	4-40	6-32	1 1/4	32
TW-3	3	6-32	8-32	1 1/4	32
TW-4	4	8-32	10-32	1 1/4	32
TW-5	5	10-32	1/4-28	1 1/4	32
TWB-6	6	1/4-28	5/16-24	1 1/2	38
TWB-7	7	5/16-24	3/8-24	1 1/2	38
TWB-8	8	3/8-24	7/16-20	1 1/2	38

5/16" Hex Power Drive



Part Number	Recess Size	Screw Size Tension Head	Screw Size Shear Head	Overall Length In.	Overall Length mm
TWA-6	6	1/4-28	5/16-24	1 1/4	32
TWA-7	7	5/16-24	3/8-24	1 1/4	32
TWA-8	8	3/8-24	7/16-20	1 1/4	32

7/16" Hex Power Drive



Part Number	Recess Size	Screw Size Tension Head	Screw Size Shear Head	Overall Length In.	Overall Length mm
TW-6	6	1/4-28	5/16-24	1 1/4	32
TW-7	7	5/16-24	3/8-24	1 1/4	32

3/4" Hex Power Drive



Part Number	Recess Size	Screw Size Tension Head	Screw Size Shear Head	Overall Length In.	Overall Length mm
TW-14	14	7/8-14	1-12	3	76
TW-15	15	1-12	-	3	76

Hi-Torque®

1/4" Square Drive Insert Bits

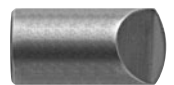

Part Number	Recess	Overall Length In.	Body Diameter In.	Blade Thickness In.	Blade Width In.
HTS-0	0	1	1/2	,029	,167
HTS-1	1	1	1/2	,049	,274
HTS-2	2	1	1/2	,059	,295
HTS-3	3	1	1/2	,059	,377
HTS-4	4	1	1/2	,073	,502

3/8" Square Drive Insert Bits



Part Number	Recess	Overall Length In.	Body Diameter In.	Blade Thickness In.	Blade Width In.
HTS-3A	3	1	3/4	,059	,377
HTS-4A	4	1	3/4	,073	,502
HTS-5	5	1 1/4	3/4	,079	,629
HTS-6	6	1 1/4	3/4	,095	,745

1/2" Square Drive Insert Bits



Part Number	Recess	Overall Length In.	Body Diameter In.	Blade Thickness In.	Blade Width In.
HTS-7	7	1 5/8	1	,112	,884
HTS-8	8	1 5/8	1	,142	,995
HTS-9	9	1 5/8	1 1/4	,162	1,136
HTS-10	10	1 5/8	1 1/4	,182	1,250
HTS-12	12	2 3/8	1 1/4	,216	1,500

1/4" Hex Insert Bits



Part Number	Recess	Overall Length In.	Body Diameter In.	Blade Thickness In.	Blade Width In.
HTN-B-1	1	1 1/4	9/32	,049	,274
HTN-B-2	2	1 1/4	5/16	,059	,295
HTN-B-3	3	1 1/4	3/8	,059	,377
HTN-B-4	4	1 1/4	1/2	,073	,502

Nominal Screw Size	0	1	2	3	4	5	6	8	10	1/4	5/16	3/8	7/16	1/2	9/16	5/8	3/4
Hi-Torque Recess	0	0	0	1	1	1	1	2	3	4	5	6	7	8	9	10	12

APEX® Solutions

Does Apex offer magnetic bit holders?

Bit holders, like this Apex M-490, let you use a variety of insert bits in power tool applications. You get economy and flexibility – and fasteners can be magnetically held to the bit.

(See page 31)



If the tool you need does not appear in this catalog, give us a call. The odds are, we may have what you need as a non-catalog item. If not, our experienced staff of tooling experts can design and manufacture “specials” to meet the needs of your specific application.

Give us a call at +49 7363-81-129 or visit our website www.apexpowertools.eu

Do Apex quick-release bit holders hold bits securely?

A quick-release bit holder allows fast, easy insert bit changes while assuring that bits stay securely in the bit holder. Simply pull back on the knurled sleeve to release the bit.

(See page 31)



Does Apex offer quick release chucks?

Apex has a complete line of quick release chucks that provide fast and easy power bit changes.

(See page 31)



Bitholder

1/4" Hex Drive for 1/4" Hex Inserts

Part Number	Overall Length	
	In.	mm



Non-magnetic

490	2 1/8	54
490-3	3	76
490-4	4	102
490-5	5	127
490-6	6	152
490-8	8	203
490-10	10	254



M-490-2	2	51	magnetic
M-490-NR	2 31/32	75	magnetic; no lock ring
M-490	2 31/32	75	magnetic
M-497	3 3/32	79	magnetic; 3/8" (9.5mm) turned shank
M-490-4	4	102	magnetic
M-490-6	6	152	magnetic
M-490-8	8	203	magnetic
M-490-10	10	254	magnetic
M-490-12	12	304	magnetic
M-44-90	3 1/4	83	magnetic; for Flip-Tip™ ureversible bits



M-495	2 7/8	73	magnetic; 3/8" (9.5mm) turned shank
M-495-5	5	127	magnetic; 3/8" (9.5mm) turned shank



RM-490	2 7/8	73	magnetic; nose piece only, #490-RN
RM-490-4	4	102	magnetic; nose piece only, #490-RN
RM-490-6	6	152	magnetic; nose piece only, #490-RN



M-490-2-OR	2	51	magnetic; with O-Ring retainer
M-490-OR	3	76	magnetic; with O-Ring retainer

1/4" Hex Drive for 1/4" Hex Inserts, Quick Release



Part Number	Overall Length	
	In.	mm

QR-M-490-2	2	51	magnetic
QR-M-490-A	2 29/32	74	magnetic
QR-M-490-A6	6	152	magnetic
QR-M-490-200M	7 7/8	200	magnetic

1/4" Hex Drive for 5/16" Hex Inserts



Part Number	Overall Length	
	In.	mm

498	2 3/8	60	
M-498	3 1/16	78	magnetic

5/16" Hex Drive



Part Number	Overall Length	
	In.	mm

630	1 13/16	46	für 1/4" hex inserts
M-630	3	76	für 1/4" hex inserts, magnetic
638	2 1/2	64	für 5/16" hex inserts
M-638	3 3/32	79	für 5/16" hex inserts, magnetic

5/16" Buckeye-Desoutter for 1/4" Hex Inserts



Part Number	Overall Length	
	In.	mm

610	2	51	
M-61	3 3/16	81	magnetic

7/16" Hex Drive



Part Number	Overall Length	
	In.	mm

488	2 3/4	70	für 1/4" hex inserts
M-488	3 1/16	78	für 1/4" hex inserts, magnetic
480	2 3/4	70	für 5/16" hex inserts
M-480	3 5/16	84	für 5/16" hex inserts, magnetic
M-480-6	6	152	für 5/16" hex inserts, magnetic

9/32" 130-A Yankee Type for 1/4" Hex Inserts



Part Number	Overall Length	
	In.	mm

450	2 1/4	57	
M-450	3 3/8	86	magnetic

5/16" 131-A Yankee Type for 1/4" Hex Inserts



Part Number	Overall Length	
	In.	mm

460	2 1/4	57	
M-460	3 3/8	86	magnetic

7/32" 135-A Yankee Type for 1/4" Hex Inserts



Part Number	Overall Length	
	In.	mm

M-470	3 3/8	86	magnetic
-------	-------	----	----------

1/4"-24 Screw Shank for 1/4" Hex Inserts



Part Number	Overall Length	
	In.	mm

400-BH	1 1/8	29
--------	-------	----

Bitholder

1/4" Female Square Drive



Part Number	Overall Length		
	In.	mm	
825	1	25	für 1/4" hex inserts
M-825	2 9/32	58	für 1/4" hex inserts, magnetic
820	23/32	18	für 1/4" square inserts

3/8" Female Square Drive



Part Number	Overall Length		
	In.	mm	
838	1 1/2	38	für 1/4" hex inserts
M-838	2 23/32	69	für 1/4" hex inserts, magnetic
835	1 1/2	38	für 5/16" hex inserts
M-835	2 3/4	70	für 5/16" hex inserts, magnetic
830	1 1/2	38	für 5/16" square inserts

1/2" Female Square Drive



Part Number	Overall Length		
	In.	mm	
858	1 3/4	45	für 1/4" hex inserts
M-858	2 3/4	70	für 1/4" hex inserts, magnetic
855	1 3/4	45	für 5/16" hex inserts
M-855	2 3/4	70	für 5/16" hex inserts, magnetic
850	1 3/4	45	für 5/16" square inserts

Bit Holders/Adapters with Set Screw or Thru Hole

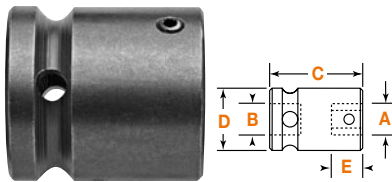

Part Number	Set Screw Lock	Spring Pin Retainer	Spring Pin Only	Hex Opening		Square Drive		Overall Length (C)		Body Dia. (D)		Opening Depth (E)	
				(A) In.	(B) In.	(B) In.	(A) In.	In.	mm	In.	mm	In.	mm
SC-108				1/4	1/4	1 1/4	32	3/4	19	5/8	16		
SC-308				1/4	3/8	1 1/2	38	3/4	19	5/8	16		
SC-508				1/4	1/2	1 1/2	38	7/8	22	5/8	16		
SC-114				7/16	1/4	1	25	3/4	19	17/32	13		
SC-314	RP-314	21-S-156-0750		7/16	3/8	1 3/8	35	3/4	19	17/32	13		
SC-514	RP-514	21-S-156-0937		7/16	1/2	1 5/8	41	15/16	24	17/32	13		
SC-614	RP-614	21-S-156-0375		7/16	5/8	1 3/4	46	1 1/4	32	17/32	13		
SC-520	RP-520	21-S-187-1125		5/8	1/2	1 1/2	38	1 1/8	29	11/16	17		
SC-620	RP-620	21-S-187-1250		5/8	5/8	1 1/2	38	1 1/4	32	11/16	17		
SC-720	RP-720	21-S-187-1500		5/8	3/4	1 11/16	43	1 1/2	38	11/16	17		
SC-820	RP-820	21-S-187-1375		5/8	1	2 1/8	54	2 1/8	54	11/16	17		
SC-724	RP-724	21-S-187-1500		3/4	3/4	2	51	1 5/8	42	7/8	22		
SC-728	RP-728	21-S-187-1625		7/8	3/4	2	51	1 5/8	42	57/64	23		
SC-828	RP-828	21-S-187-1625		7/8	1	2 1/8	54	2 1/8	54	5/8	23		

Note: Use SC bit holders with socket head inserts (page 19) and pipe plug inserts (page 21). Can be used with power bits.

Female Threaded Drive, Quick Releasing Chucks



Part Number	Female Thread	Hex Opening In.	Overall Length		Overall Diameter		Opening Depth	
			In.	mm	In.	mm	In.	mm
QRA-08	3/8"-24	1/4	1 3/4	45	3/4	19	61/64	24
QRA-14	3/8"-24	7/16	2	51	1 1/4	32	1 1/16	27
QRF-08	1/2"-20	1/4	1 3/4	45	3/4	19	61/64	24
QRF-14	1/2"-20	7/16	2	51	1 1/4	32	1 1/16	27
QRF-20	1/2"-20	5/8	2 5/8	67	1 5/8	41	1 1/2	38

Female Square Drive, Quick Releasing Chucks

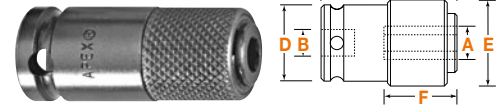

Part Number	Hex Open (A) In.	Square Drive (B) In.	Overall Length (C)		Body Diameter (D)		Sleeve Diameter (E)		Opening Depth (F)	
			In.	mm	In.	mm	In.	mm	In.	mm
QR-108	1/4	1/4	1 1/2	38	3/4	19	3/4	19	61/64	24
QR-308	1/4	3/8	1 3/4	45	3/4	19	3/4	19	61/64	24
QR-508	1/4	1/2	2 1/8	54	7/8	22	3/4	19	61/64	24
QR-314	7/16	3/8	2	51	1	25	1 1/4	32	1 3/32	28
QR-514	7/16	1/2	2 1/8	54	1	25	1 1/4	32	1 1/16	27
QR-614	7/16	5/8	2 1/8	54	1 1/4	32	1 1/4	32	1 1/16	27
QR-714	7/16	3/4	2 3/8	60	1 1/2	38	1 1/4	32	1 1/16	27
QR-520	5/8	1/2	2 5/8	67	1 1/2	38	1 5/8	41	1 1/2	38
QR-620	5/8	5/8	2 5/8	67	1 1/2	38	1 5/8	41	1 1/2	38
QR-720	5/8	3/4	3 1/8	79	1 1/2	38	1 5/8	41	1 1/2	38
QR-820	5/8	1	3 1/4	83	2 1/8	54	1 5/8	41	1 1/2	38
QR-824	3/4	1	3 3/4	95	2	51	1 7/8	48	1 5/8	41

1/4" Hex Drive Nutsetters for Sheet Metal Screws

6 Point Power Drive, SAE



Part Number 6 Point	Size In.	Overall Length In.	Socket Nose Diameter In.		
DB-08	1/4	2 9/16	7/16	non-magnetic	
DB-10	5/16	2 9/16	1/2	non-magnetic	
DB-12	3/8	2 9/16	9/16	non-magnetic	
MDA-08	1/4	1 3/4	7/16	magnetic	
MDAT-08	1/4	1 3/4	3/8	magnetic	
MDA-10	5/16	1 3/4	1/2	magnetic	
MDA-12	3/8	1 3/4	9/16	magnetic	
MDA-14	7/16	2	11/16	magnetic	
MDB-08	1/4	2 9/16	7/16	magnetic	5/16" Shank Diameter
MDB-10	5/16	2 9/16	1/2	magnetic	5/16" Shank Diameter
MDB-12	3/8	2 9/16	9/16	magnetic	5/16" Shank Diameter
MDB-14	7/16	2 9/16	5/8	magnetic	5/16" Shank Diameter
MDC-08	1/4	2 9/16	7/16	magnetic	3/8" Shank Diameter
MDC-10	5/16	2 9/16	1/2	magnetic	3/8" Shank Diameter
MDC-12	3/8	2 9/16	9/16	magnetic	3/8" Shank Diameter

6 Point Insert, SAE



Part Number 6 Point	Size In.	Overall Length In.	Socket Nose Diameter In.	
MHM-1310	5/16	1 1/8	1/2	magnetic
MHM-1912	3/8	1 3/4	9/16	magnetic

6 Point Power Drive, Metric



Part Number 6 Point	Size In.	Overall Length In.	Socket Nose Diameter In.	
MDA-6MM	6	44,5	9,5	magnetic
MDA-7MM	7	44,5	11,1	magnetic
MDA-8MM	8	44,5	12,7	magnetic
MDA-10MM	10	44,5	14,3	magnetic
MDA-10MM-80MM	10	80,0	14,3	magnetic

6 Point Insert, Metric



Part Number 6 Point	Size In.	Overall Length In.	Socket Nose Diameter In.	
MHM-7MM	7	31,8	11,1	magnetic
MHM-8MM	8	31,8	12,7	magnetic
MHM-10MM	10	31,8	14,3	magnetic

1/4" Hex Drive Nutsetters

6 Point and 6 Point Magnetic, SAE



Part Number 6 Point	Part Number Magnetic	Size In.	Overall Length In.	Socket Nose Diameter In.
6N-0806-2	M6N-0806-2	3/16	2	5/16
6N-0806-3	M6N-0806-3	3/16	3	5/16
-	M6N-0806-5	3/16	5	5/16
-	M6N-0806-6	3/16	6	5/16
6N-0808-2	M6N-0808-2	1/4	2	7/16
6N-0808-3	M6N-0808-3	1/4	3	7/16
6N-0808-4	M6N-0808-4	1/4	4	7/16
6N-0808-5	M6N-0808-5	1/4	5	7/16
6N-0808-6	M6N-0808-6	1/4	6	7/16
6N-0810-2	M6N-0810-2	5/16	2	1/2
6N-0810-3	M6N-0810-3	5/16	3	1/2
6N-0810-4	M6N-0810-4	5/16	4	1/2
6N-0810-5	M6N-0810-5	5/16	5	1/2
6N-0810-6	M6N-0810-6	5/16	6	1/2
6N-0811-2	M6N-0811-2	11/32	2	9/16
6N-0811-3	M6N-0811-3	11/32	3	9/16
6N-0812-2	M6N-0812-2	3/8	2	9/16
6N-0812-3	M6N-0812-3	3/8	3	9/16
6N-0812-4	M6N-0812-4	3/8	4	9/16
6N-0812-6	M6N-0812-6	3/8	6	9/16
6N-0814-2	M6N-0814-2	7/16	2	21/32
6N-0814-3	M6N-0814-3	7/16	3	21/32
6N-0814-4	M6N-0814-4	7/16	4	21/32
6N-0814-6	M6N-0814-6	7/16	6	21/32
6N-0816-2	M6N-0816-2	1/2	2	3/4
6N-0816-3	M6N-0816-3	1/2	3	3/4
6N-0818-2	M6N-0818-2	9/16	2	13/16

6 Point and 6 Point Magnetic, Metric



Part Number 6 Point	Part Number Magnetic	Size In.	Overall Length In.	Socket Nose Diameter In.
6N-08-8M-3	M6N-08-8M-3	8	76	12,7
6N-08-8M-4	M6N-08-8M-4	8	102	12,7
6N-08-8M-6	M6N-08-8M-6	8	152	12,7
6N-08-10M-3	M6N-08-10M-3	10	76	14,3
6N-08-10M-4	M6N-08-10M-4	10	102	14,3
6N-08-10M-6	M6N-08-10M-6	10	76	14,3
6N-08-12M-3	M6N-08-12M-3	12	76	19,0
6N-08-12M-4	M6N-08-12M-4	12	102	19,0
6N-08-12M-6	M6N-08-12M-6	12	152	19,0

1/4" Hex Drive Nutsetters

6 Point, Bolt Clearance

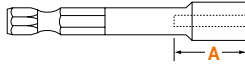

Part Number	Size In.	Overall Length In.	Socket Nose Diameter In.	Depth Clearance (A) In.
6B-0808	1/4	3 1/4	7/16	1 3/8
6B-0809	9/32	3 1/4	1/2	1 3/8
6B-0810	5/16	3 1/4	1/2	1 3/8
6B-0811	11/32	3 1/4	9/16	1 3/8
6B-0812	3/8	3 1/4	9/16	1 3/8
6B-0814	7/16	3 1/4	21/32	1 3/8
6B-0816	1/2	3 1/4	3/4	1 3/8
6B-0818	9/16	3 1/4	13/16	1 3/8
6B-0820	5/8	3 1/4	7/8	1 3/8

See bolt clearance Tool Tip page 38.

7/16" Hex Drive Nutsetters

6 Point



Part Number	Size In.	Overall Length In.	Socket Nose Diameter In.
6N-1410-3	5/16	3	9/16
6N-1412-3	3/8	3	9/16
6N-1414-3	7/16	3	3/4
6N-1416-3	1/2	3	13/16
6N-1416-4	1/2	4	13/16
6N-1418-3	9/16	3	7/8
6N-1418-6	9/16	6	7/8
6N-1420-3	5/8	3	1
6N-1424-3	3/4	3	1 1/8
6N-1424-6	3/4	6	1 1/8

5/8" Hex Drive Nutsetters

6 Point



Part Number	Size In.	Overall Length In.	Socket Nose Diameter In.
6N-2028-4	7/8	4	1 3/8
6N-2036-4	1 1/8	4	1 5/8

Hand Drivers

Drivers with Self-Contained Insert Bits



Part Number	Female Hex Size	Overall Length In.	Overall Length mm	Blade Projection In.	Blade Projection mm	
M-15-SC	1/4	8 1/2	216	4 3/8	111	Phillips #1, #2, #3; Slotted 4F-5R, 10F-12-R; hollow handle
M-15-SC-A	1/4	8 1/2	216	4 3/8	111	without bits, hollow handle

Replaceable Bit Drivers



Part Number	Female Hex Size	Overall Length In.	Overall Length mm	Blade Projection In.	Blade Projection mm
1510-P	1/4	2 3/4	70	7/8	22
1500-P	1/4	7 1/2	191	3 9/32	83

Replaceable Bit Drivers – magnetic



Part Number	Female Hex Size	Overall Length In.	Overall Length mm	Blade Projection In.	Blade Projection mm
M-1505-P	1/4	2 3/8	60	3/8	10
M-1500-P	1/4	8 1/2	216	4 3/8	111

Industrial Bit Kit



24 Bit Kit

Tool kit includes plastic carrying case with:
Magnetic hand driver and magnetic bit holder.

Phillips bits: #1, #2, #3

Slotted bits: 3F-4R, 4F-5R, 6F-8R, 8F-10R, 10F-12R

Torx® bits: T-10, T-15, T-20, T-25, T-27, T-30, T-40

Square Recess bits: 3/32", 1/8"

Hex bits: 5/64", 3/32", 7/64", 1/8", 9/64"

Pozidriv® bits: #1, #2

Awls



Part Number	Overall Length In.	Overall Length mm	Shank Diameter In.	Shank Diameter mm
AW-95	7 7/16	189	.307	7,8
AW-95-L	8	203	.307	7,8
AW-95-LL	8 7/8	225	.307	7,8

Hex Extensions

Male Hex Drive with 1/4" Male Square



Part Number	Hex Drive In.	Type of Lock	Overall Length In.	Overall Length mm
EX-250	1/4	Pin	1 3/8	35
EX-250-B	1/4	Ball	1 3/8	35
EX-250-2	1/4	Pin	2	51
EX-250-B-2	1/4	Ball	2	51
EX-250-3	1/4	Pin	3	76
EX-250-B-3	1/4	Ball	3	76
EX-250-4	1/4	Pin	4	102
EX-250-B-4	1/4	Ball	4	102
EX-250-5	1/4	Pin	5	127
EX-250-B-5	1/4	Ball	5	127
EX-250-6	1/4	Pin	6	152
EX-250-B-6	1/4	Ball	6	152
EX-250-8	1/4	Pin	8	203
EX-250-B-8	1/4	Ball	8	203
EX-250-12	1/4	Pin	12	305
EX-250-B-12	1/4	Ball	12	305
EX-262	5/16	Pin	1 1/2	38
EX-262-4	5/16	Pin	4	102
EX-262-B-4	5/16	Ball	4	102
EX-262-6	5/16	Pin	6	152
EX-251	7/16	Pin	1 3/8	35
EX-251-B	7/16	Ball	1 3/8	35
EX-251-2	7/16	Pin	2	51
EX-251-B-2	7/16	Ball	2	51
EX-251-3	7/16	Pin	3	76
EX-251-6	7/16	Pin	6	152
EX-251-8	7/16	Pin	8	203
EX-251-10	7/16	Pin	10	254

Male Hex Drive with 3/8" Male Square



Part Number	Hex Drive In.	Type of Lock	Overall Length In.	Overall Length mm
EX-370	1/4	Pin	1 5/8	41
EX-370-B	1/4	Ball	1 5/8	41
EX-370-2	1/4	Pin	2	51
EX-370-B-2	1/4	Ball	2	51
EX-370-3	1/4	Pin	3	76
EX-370-B-3	1/4	Ball	3	76
EX-370-4	1/4	Pin	4	102
EX-370-B-4	1/4	Ball	4	102
EX-370-5	1/4	Pin	5	127
EX-370-6	1/4	Pin	6	152
EX-370-B-6	1/4	Ball	6	152
EX-370-8	1/4	Pin	8	203
EX-370-B-8	1/4	Ball	8	203
EX-370-10	1/4	Pin	10	254
EX-370-B-10	1/4	Ball	10	254
EX-380	5/16	Pin	1 1/2	38
EX-380-B	5/16	Ball	1 1/2	38
EX-380-2	5/16	Pin	2	51
EX-380-B-2	5/16	Ball	2	51
EX-380-3	5/16	Pin	3	76
EX-380-4	5/16	Pin	4	102
EX-380-6	5/16	Pin	6	152
EX-371	7/16	Pin	1 3/4	45
EX-371-2	7/16	Pin	2	51
EX-371-2 3/4	7/16	Pin	2 3/4	70
EX-371-3	7/16	Pin	3	76
EX-371-B-3	7/16	Ball	3	76
EX-371-4	7/16	Pin	4	102
EX-371-5	7/16	Pin	5	127
EX-371-6	7/16	Pin	6	152
EX-371-8	7/16	Pin	8	203
EX-371-10	7/16	Pin	10	254
EX-371-12	7/16	Pin	12	305
EX-371-15	7/16	Pin	15	381

Hex Extensions

Male Hex Drive with 1/2" Male Square



Part Number	Hex Drive In.	Type of Lock	Overall Length	
			In.	mm
EX-500-2	1/4	Pin	2	51
EX-500-B-2	1/4	Ball	2	51
EX-500-3	1/4	Pin	3	76
EX-500-B-3	1/4	Ball	3	76
EX-500-4	1/4	Pin	4	102
EX-500-B-4	1/4	Ball	4	102
EX-500-6	1/4	Pin	6	152
EX-500-B-6	1/4	Ball	6	152
EX-512-2	5/16	Pin	2	51
EX-512-B-2	5/16	Ball	2	51
EX-512-3	5/16	Pin	3	76
EX-512-B-4	5/16	Ball	4	102
EX-501-2	7/16	Pin	2 1/8	54
EX-501-B-2	7/16	Ball	2 1/8	54
EX-501-3	7/16	Pin	3	76
EX-501-B-3	7/16	Ball	3	76
EX-501-4	7/16	Pin	4	102
EX-501-B-4	7/16	Ball	4	102
EX-501-5	7/16	Pin	5	127
EX-501-B-5	7/16	Ball	5	127
EX-501-6	7/16	Pin	6	152
EX-501-B-6	7/16	Ball	6	152
EX-501-8	7/16	Pin	8	203
EX-501-B-8	7/16	Ball	8	203
EX-501-10	7/16	Pin	10	254
EX-501-B-10	7/16	Ball	10	254
EX-501-12	7/16	Pin	12	305
EX-501-B-12	7/16	Ball	12	305
EX-501-15	7/16	Pin	15	381
EX-502	5/8	Pin	2	51
EX-502-B	5/8	Ball	2	51
EX-502-3	5/8	Pin	3	76
EX-502-B-3	5/8	Ball	3	76
EX-502-4	5/8	Ball	4	102
EX-502-5	5/8	Pin	5	127
EX-502-6	5/8	Pin	6	152
EX-502-8	5/8	Pin	8	203

Male Hex Drive with 5/8" Male Square



Part Number	Hex Drive In.	Type of Lock	Overall Length	
			In.	mm
EX-620-3	7/16	Pin	3	76
EX-620-6	7/16	Pin	6	152
EX-621-3	5/8	Pin	3	76
EX-621-B-3	5/8	Ball	3	76
EX-621-6	5/8	Pin	6	152
EX-621-8	5/8	Pin	8	203

Male Hex Drive with 3/4" Male Square



Part Number	Hex Drive In.	Type of Lock	Overall Length	
			In.	mm
EX-757-3	7/16	7/32 Drill Hole	3	76
EX-757-B-3	7/16	Ball	3	76
EX-758-4	5/8	7/32 Drill Hole	4	102
EX-758-B-4	5/8	Ball	4	102
EX-758-6	5/8	7/32 Drill Hole	6	152
EX-758-9	5/8	7/32 Drill Hole	9	229

Extensions

Threaded Screw Shank



Part Number	Male Square In.	Male Thread In.	Overall Length		Body Diameter	
			In.	mm	In.	mm
TH-256	1/4	1/4-28	1 5/8	41	7/16	11
TH-376	3/8	1/4-28	1 5/8	41	1/2	13
TH-250	1/4	1/4-24	1 5/8	41	7/16	11
TH-370	3/8	1/4-24	1 3/4	45	1/2	13
TH-372	3/8	1/4-20	1 3/4	45	1/2	13

1/4" Male Hex Universal Wrenches

SAE 6 Point, Standard & Tension Type – Extension

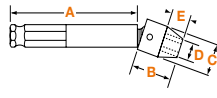

Part Number Standard	Part Number Tension	Hex Opening In.	Shank Length (A) In.	Socket Length (B) In.	Socket Diameter (C) In.	Nose End Diameter (D) In.	Clearance Depth (E) In.
KC-25-3	-	1/4	3	3/4	5/8	3/8	3/8
KC-25-4	-	1/4	4	3/4	5/8	3/8	3/8
KC-25-6	KS-25-6	1/4	6	3/4	5/8	3/8	3/8
KC-25-9	-	1/4	9	3/4	5/8	3/8	3/8
KC-25-12	-	1/4	12	3/4	5/8	3/8	3/8
KC-26-3	-	5/16	3	3/4	5/8	7/16	3/8
KC-26-6	KS-26-6	5/16	6	3/4	5/8	7/16	3/8
KC-26-9	-	5/16	9	3/4	5/8	7/16	3/8
KC-26-12	KS-26-12	5/16	12	3/4	5/8	7/16	3/8
-	KS-100-6	5/16	6	3/4	3/4	7/16	5/16
KC-27-3	-	11/32	3	3/4	5/8	1/2	3/8
KC-27-6	-	11/32	6	3/4	5/8	1/2	3/8
KC-101-6	-	11/32	6	3/4	3/4	15/32	5/16
KC-28-3	-	3/8	3	13/16	5/8	9/16	7/16
KC-28-6	KS-28-6	3/8	6	13/16	5/8	9/16	7/16
-	KS-28-12	3/8	12	13/16	5/8	9/16	7/16
-	KS-102-6	3/8	6	13/16	3/4	9/16	3/8
KC-29-3	-	7/16	3	7/8	5/8	5/8	1/2
KC-29-6	KS-29-6	7/16	6	7/8	5/8	5/8	1/2
KC-30-3	-	1/2	3	7/8	11/16	11/16	1/2
KC-30-4	-	1/2	4	7/8	11/16	11/16	1/2
KC-30-6	KS-30-6	1/2	6	7/8	11/16	11/16	1/2
KC-30-9	-	1/2	9	7/8	11/16	11/16	1/2
-	KS-104-6	1/2	6	1	3/4	3/4	9/16
KC-105-6	KS-105-6	9/16	6	1	13/16	13/16	9/16
-	KS-105-9	9/16	9	1	13/16	13/16	9/16

7/16" 1/4" Male Hex Universal Wrenches

SAE 6 Point, Standard & Tension Type – Extension

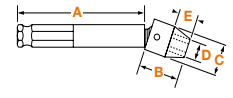

Part Number Standard	Part Number Tension	Hex Opening In.	Shank Length (A) In.	Socket Length (B) In.	Socket Diameter (C) In.	Nose End Diameter (D) In.	Clearance Depth (E) In.
KB-43-6	-	3/8	6	13/16	5/8	7/32	7/16
-	KT-44-6	7/16	6	7/8	5/8	5/8	1/2
KB-45-3	-	1/2	3	7/8	11/16	11/16	1/2
KB-45-4	-	1/2	4	7/8	11/16	11/16	1/2
KB-104-6	KT-104-6	1/2	6	1	3/4	3/4	9/16
KB-202-6	KT-202-6	1/2	6	1	7/8	11/16	15/32
-	KT-202-9	1/2	9	1	7/8	11/16	15/32
KB-202-12	KT-202-12	1/2	12	1	7/8	11/16	15/32
KB-317-9	KT-317-9	1/2	9	1	1	11/16	7/16
KB-105-3	-	9/16	3	1	13/16	13/16	9/16
-	KT-105-6	9/16	6	1	13/16	13/16	9/16
-	KT-105-9	9/16	9	1	13/16	13/16	9/16
-	KT-105-12	9/16	12	1	13/16	13/16	9/16
-	KT-203-6	9/16	6	1 1/16	7/8	3/4	17/32
KB-203-9	KT-203-9	9/16	9	1 1/16	7/8	3/4	17/32
KB-203-12	KT-203-12	9/16	12	1 1/16	7/8	3/4	17/32
-	KT-318-6	9/16	6	1 1/8	1	3/4	9/16
KB-318-12	-	9/16	12	1 1/8	1	3/4	9/16
KB-205-6	KT-205-6	5/8	6	1 1/8	7/8	7/8	19/32
KB-205-12	KT-205-12	5/8	12	1 1/8	7/8	7/8	19/32
KB-320-6	KT-320-6	5/8	6	1 3/16	1	27/32	5/8
-	KT-320-9	5/8	9	1 3/16	1	27/32	5/8
-	KT-320-12	5/8	12	1 3/16	1	27/32	5/8
KB-321-6	-	11/16	6	1 1/4	1	1	11/16
KB-322-3	-	3/4	3	1 1/4	1 1/8	1 1/8	11/16
KB-322-6	KT-322-6	3/4	6	1 1/4	1 1/8	1 1/8	11/16
-	KT-322-9	3/4	9	1 1/4	1 1/8	1 1/8	11/16

Metric 6 Point, Standard & Tension Type – Extension

Part Number Standard	Part Number Tension	Hex Opening mm	Shank Length (A) mm	Socket Length (B) mm	Socket Diameter (C) mm	Nose End Diameter (D) mm	Clearance Depth (E) mm
KC-5-7m-4	-	7	102	19.1	15.9	10.3	9.5
KC-5-7m-6	KS-5-7m-6	7	152	19.1	15.9	10.3	9.5
-	KS-5-7m-9	7	229	19.1	15.9	10.3	9.5
KC-6-8m-3	-	8	76	19.1	19.1	11.1	7.9
KC-6-8m-4	-	8	102	19.1	19.1	11.1	7.9
KC-6-8m-6	KS-6-8m-6	8	152	19.1	19.1	11.1	7.9
-	KS-6-8m-9	8	229	19.1	19.1	11.1	7.9
KC-6-9m-6	-	9	152	19.1	19.1	12.7	7.9
KC-6-10m-3	-	10	76	20.6	19.1	15.1	9.5
KC-6-10m-4	-	10	102	20.6	19.1	15.1	9.5
KC-6-10m-6	KS-6-10m-6	10	152	20.6	19.1	15.1	9.5
KC-6-10m-9	KS-6-10m-9	10	229	20.6	19.1	15.1	9.5
KC-6-10m-12	-	10	305	20.6	19.1	15.1	9.5
KC-7-11m-6	KS-7-11m-6	11	152	23.8	22.2	15.9	10.3
KC-7-12m-3	-	12	76	23.8	22.2	17.5	10.3
KC-7-12m-6	-	12	152	23.8	22.2	17.5	10.3
KC-7-12m-9	-	12	229	23.8	22.2	17.5	10.3
KC-7-13m-3	-	13	76	25.4	22.2	17.5	11.9
KC-7-13m-6	KS-7-13m-6	13	152	25.4	22.2	17.5	11.9
KC-7-13m-9	KS-7-13m-9	13	229	25.4	22.2	17.5	11.9

Actual design of universal wrenches may not be exactly like pictures above.

Universal wrenches must not be used with impact drivers. Maximum operating angle is 30°.

Metric 6 Point, Standard & Tension Type – Extension

Part Number Standard	Part Number Tension	Hex Opening mm	Shank Length (A) mm	Socket Length (B) mm	Socket Diameter (C) mm	Nose End Diameter (D) mm	Clearance Depth (E) mm
KB-6-10m-6	KT-6-10m-6	10	152	20.6	19.1	15.1	9.5
-	KT-6-10m-9	10	229	20.6	19.1	15.1	9.5
-	KT-6-10m-12	10	305	20.6	19.1	15.1	9.5
KB-7-11m-6	-	11	152	23.8	22.2	15.9	10.3
KB-7-13m-3	-	13	76	25.4	22.2	17.5	11.9
KB-7-13m-6	KT-7-13m-6	13	152	25.4	22.2	17.5	11.9
KB-7-13m-9	KT-7-13m-9	13	229	25.4	22.2	17.5	11.9
KB-7-13m-12	-	13	305	25.4	22.2	17.5	11.9
KB-7-14m-6	KT-7-14m-6	14	152	27.0	22.2	19.1	13.5
-	KT-7-14m-12	14	305	27.0	22.2	19.1	14.3
-	KT-7-15m-6	15	152	27.0	22.2	19.1	14.3
KB-8-15m-6	KT-8-15m-6	15	152	28.6	25.4	19.8	14.3
KB-8-15m-9	KT-8-15m-9	15	229	28.6	25.4	19.8	14.3
KB-8-15m-12	KT-8-15m-12	15	305	28.6	25.4	19.8	14.3
KB-8-16m-6	KT-8-16m-6	16	152	30.2	25.4	21.4	15.9
KB-8-16m-9	KT-8-16m-9	16	229	30.2	25.4	21.4	15.9
-	KT-8-16m-12	16	305	30.2	25.4	21.4	15.9
-	KT-8-17m-6	17	152	31.8	25.4	25.4	17.5
KB-8-17m-12	KT-8-13m-12	17	305	31.8	25.4	25.4	17.5
KB-8-18m-6	KT-8-18m-6	18	152	31.8	25.4	25.4	17.5
-	KT-8-18m-9	18	229	31.8	25.4	25.4	17.5
-	KT-8-18m-12	18	305	31.8	25.4	25.4	17.5
KB-10-19m-6	KT-10-19m-6	19	152	34.9	31.8	26.2	16.3

Actual design of universal wrenches may not be exactly like pictures above.

Universal wrenches must not be used with impact drivers. Maximum operating angle is 30°.

APEX® Solutions



When can I use a universal adapter?

A universal adapter gives all of your sockets the versatility of a universal wrench. Universal adapters must not be used with impact drivers.

(See page 42)

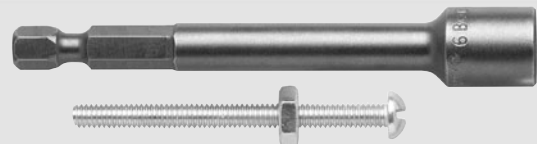

Bietet Apex Schraubwerkzeuge mit Freiraum für Gewindebolzen an?

Bolt clearance nutsetters allow the bolt or stud to recess into the nutsetter body as the nut is driven down. Bolt clearance nutsetters are prefixed with the numbers 6B-.

(See page 34)

Does Apex offer Torx® sockets?

Like Torx® screws, Torx® bolts are becoming commonplace in a variety of assembly applications. Apex offers a wide variety of Torx® sockets.

(See page 45)



What is the advantage of surface drive sockets?

Use surface drive sockets if tools are still running when they engage the fasteners (such as on this multi-spindle machine). They're easier to engage and will result in less tool wear.



Does Apex offer universal wrenches with longer sockets?

Universal wrenches are available with a longer socket to allow a stud to recess into the socket opening.

(Check with your Apex representative for details.)

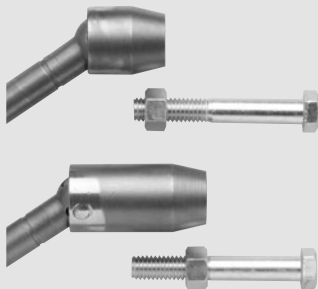

If the tool you need does not appear in this catalog, give us a call. The odds are, we may have what you need as a non-catalog item. If not, our experienced staff of tooling experts can design and manufacture "specials" to meet the needs of your specific application.

Give us a call at +49 7363-81-129 or visit our website www.apexpowertools.eu

What is the benefit of a tension sleeve?

A universal wrench with a tension sleeve holds the socket at the desired driving angle while aligning the tool and fastener. Other universal wrench sockets can “flop” making engagement difficult.

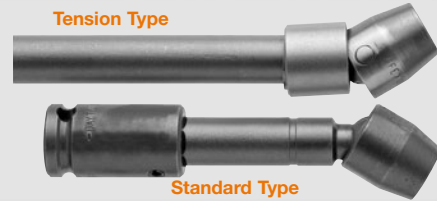

What Types of magnetic sockets does Apex offer?

In addition to a fixed magnet socket (center), Apex offers spring-loaded (left) and cylindrical (right) magnet styles that allow the bolt to recess into the socket body as the nut is driven down. Fixed magnet sockets are designated by a M- part number prefix, spring-loaded by MB- prefix and cylindrical by a SM- prefix.



Does Apex offer thin wall sockets?

Thin wall sockets accommodate countersunk or limited clearance nut or bolt locations. Many of these sockets have a shouldered body design that can fit in tight quarters.

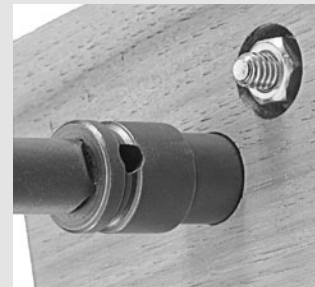

Does Apex offer a complete line of extensions?

Apex features a wide selection of extension lengths, styles and sizes. (See the Table of Contents for a complete listing.)



Does Apex offer mar resistant bits and sockets?

Apex can nylon coat just about any of our bits or sockets. Nylon offers excellent mar resistance for assemblies that have painted, varnished or chromed surfaces. Nylon also offers some safety benefits by covering tool junctions.

(See pages 74-77 for more information)



Can I use my extensions, adapters and universals with impact drivers?

Quality design and construction give Apex universal wrenches a long service life and durability. Remember, universal wrenches, extensions and adapters are not to be used with impact drivers.



In this section:



Impact Sockets

Apex industrial grade impact sockets are available in a wide range of lengths and wall thicknesses, and with single or double hex openings. Square openings are available in select sizes.

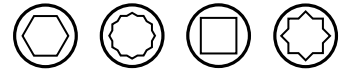

Fixed Magnetic Impact Sockets

Magnetic sockets hold the fastener in driving position, even when working straight down. Time-wasting motions are eliminated when starting fasteners or working in hard-to-reach areas. These sockets are identified with a M- prefix.



Magnetic Bolt Clearance Impact Sockets

As the nut is run down, a spring-loaded or hollow cylinder magnet allows the bolt or stud to retract into the socket body. Nuts are held firmly in the socket. These sockets are identified with a MB- prefix.



Surface Drive Sockets

Large openings on the six corners of the opening create a “floating” action that allows the socket to slip quickly and easily onto the nut or bolt. Ideal for compensating for imperfect alignment between the tool and fastener. Not generally recommended for impact use. These sockets are identified with a SF- prefix.



Fast Lead Impact Sockets

Designed for power tool and multiple spindle power tools, a specially tapered opening provides complete engagement with the nut almost instantly upon engagement. This speeds productivity and extends tool life. Engagement is possible without starting and stopping the tool for each nut. These sockets are identified with a FL- prefix.



Special Sockets

You'll find Spine, Torx®, tap holding, Budd Wheel, grease fitting and other sockets for special applications.



Extensions and Adapters

Apex provides the accessories needed to adapt sockets to nearly every tool and application.



Square Drive Universal Wrenches

Hard-to-reach areas are no problem with Apex's wide range of universal and extension universal wrenches.

1/4" Square Drive Sockets, SAE

Standard Length, 6 Point and Double Hex



Part Number 6 Point	Part Number Double Hex	Hex Opening In.	Overall Length (A)	Diameter Nose End (B)	Diameter Drive End (C)	Opening Depth (D)
1105	-	5/32	7/8	1/4	1/2	3/32
1106	1106-D	3/16	7/8	5/16	1/2	3/32
1107	1107-D	7/32	7/8	3/8	1/2	5/32
1108	1108-D	1/4	7/8	3/8	1/2	5/32
X-1108*	-	1/4	7/8	3/8	1/2	5/32
1109	1109-D	9/32	1	7/16	1/2	3/16
1110	1110-D	5/16	1	1/2	1/2	3/16
X-1110*	-	5/16	1	1/2	1/2	3/16
HA-510	-	5/16	7/8	7/16	7/16	3/16
1111	1111-D	11/32	1	9/16	9/16	3/16
1112	1112-D	3/8	1	9/16	9/16	1/4
1113	-	13/32	1	5/8	5/8	1/4
1114	1114-D	7/16	1	5/8	5/8	9/32
1116	1116-D	1/2	1	11/16	11/16	11/32
1118	-	9/16	1	13/16	13/16	7/16
1120	-	5/8	1	7/8	7/8	7/16

* Parts have a harder heat treat.

Magnetic, Standard Length, 6 Point

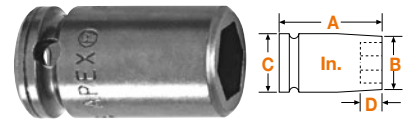

Part Number 6 Point	Hex Opening In.	Overall Length (A)	Diameter Nose End (B)	Diameter Drive End (C)	Opening Depth (D)
M-1105	5/32	7/8	5/16	1/2	3/32
M-1106	3/16	7/8	5/16	1/2	3/32
M-1107	7/32	7/8	3/8	1/2	5/32
MX-1108*	1/4	7/8	3/8	1/2	5/32
M-1108-E*	1/4	7/8	3/8	1/2	5/32
MX-1109*	9/32	1	7/16	1/2	3/16
MHA-510	5/16	7/8	7/16	7/16	1/8
M-1110	5/16	1	1/2	1/2	3/16
MX-1110*	5/16	1	1/2	1/2	3/16
MX-1111	11/32	1	1/2	1/2	3/16
M-1112	3/8	1	9/16	9/16	1/4
MX-1112*	3/8	1	9/16	9/16	1/4
M-1114	7/16	1	5/8	5/8	9/32
M-1116	1/2	1	11/16	11/16	11/32
M-1118	9/16	1	11/16	11/16	11/32

* Parts have a harder heat treat; MX-1108-E has no lead-in chamfer.

Long Length, 6 Point and Double Hex



Part Number 6 Point	Part Number Double Hex	Hex Opening In.	Overall Length (A)	Diameter Nose End (B)	Diameter Drive End (C)	Opening Depth (D)
1206	1206-D	3/16	1 3/4	5/16	1/2	3/32
1207	-	7/32	1 3/4	3/8	1/2	5/32
1208	1208-D	1/4	1 3/4	3/8	1/2	5/32
1209	1209-D	9/32	1 3/4	7/16	1/2	3/16
1210	1210-D	5/16	1 3/4	1/2	1/2	3/16
1211	-	11/32	1 3/4	9/16	9/16	3/16
1212	1212-D	3/8	1 3/4	9/16	9/16	1/4
1213	-	13/32	1 3/4	5/8	5/8	1/4
1214	-	7/16	1 3/4	5/8	5/8	9/32
1216	1216-D	1/2	1 3/4	11/16	11/16	11/32
1218	-	9/16	1 3/4	13/16	13/16	7/16

Magnetic, Long & Extra Long Length, 6 Point



Part No. Fixed Magnet	Part No. Bolt Clearance	Hex Opening In.	Overall Length (A)	Diameter Nose End (B)	Diameter Drive End (C)	Opening Depth (D)
-	MB-1206	3/16	1 3/4	5/16	1/2	5/32
M-1208	MB-1208	1/4	1 3/4	3/8	1/2	5/32
-	MB-1308	1/4	3	3/8	1/2	5/32
M-1209	MB-1209	9/32	1 3/4	7/16	1/2	3/16
M-1210	MB-1210	5/16	1 3/4	1/2	1/2	3/16
-	MB-1211	11/32	1 3/4	9/16	9/16	3/16
-	MB-1311	11/32	3	1/2	1/2	3/16
M-1212	MB-1212	3/8	1 3/4	9/16	9/16	1/4
-	MB-1312	3/8	3	9/16	9/16	1/4
M-1214	MB-1214	7/16	1 3/4	5/8	5/8	9/32
-	MB-1314	7/16	3	5/8	5/8	9/32
-	MB-1216	1/2	1 3/4	11/16	11/16	11/32
-	MB-1218	9/16	1 3/4	13/16	13/16	7/16

* For explanation of magnets, see Tool Tip on page 39.

Extra Long Length, 6 Point and Double Hex



Part Number 6 Point	Part Number Double Hex	Hex Opening In.	Overall Length (A)	Diameter Nose End (B)	Diameter Drive End (C)	Opening Depth (D)
1308	1308-D	1/4	3	3/8	1/2	5/32
1310	-	5/16	3	1/2	1/2	3/16
1311	1311-D	11/32	3	1/2	1/2	3/16
1312	-	3/8	3	9/16	9/16	1/4
1313	-	13/32	3	9/16	9/16	1/4
1314	-	7/16	3	5/8	5/8	9/32
1316	-	1/2	3	11/16	11/16	11/32
1318	-	9/16	3	13/16	13/16	7/16
1320	-	5/8	3	7/8	7/8	7/16

Surface Drive & Fast Lead, Standard & Long Length

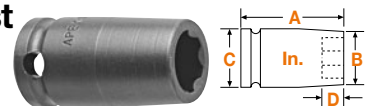

Part No. Surface Drive	Part No. Fast Lead	Hex Opening In.	Overall Length (A)	Diameter Nose End (B)	Diameter Drive End (C)	Opening Depth (D)
-	FL-1108	1/4	7/8	3/8	1/2	5/32
-	FL-1109	9/32	7/8	3/8	1/2	5/32
-	FL-1110	5/16	1	1/2	1/2	3/16
SF-1112	FL-1112	3/8	1	9/16	9/16	1/4
-	FL-1212	3/8	1 3/4	9/16	9/16	1/4
-	FL-1114	7/16	1	5/8	5/8	9/32
-	FL-1214	7/16	1 3/4	5/8	5/8	9/32
SF-1116	FL-1116	1/2	1	11/16	11/16	11/32
-	FL-1216	1/2	1 3/4	11/16	11/16	11/32

1/4" Square Drive Sockets for SAE Sheet Metal Screws

6 Point & 6 Point Magnetic, For Predrilled Holes*

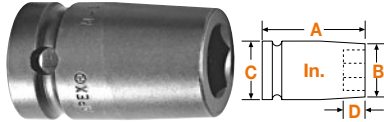

Part Number 6 Point	Part Number Magnetic	Hex Opening In.	Overall Length (A)	Diameter Nose End (B)	Diameter Drive End (C)	Opening Depth (D)
-	M1E06	3/16	7/8	5/16	1/2	3/32
-	M1E07	7/32	7/8	3/8	1/2	5/32
1E08	M1E08	1/4	7/8	3/8	1/2	5/32
1E10	M1E10	5/16	7/8	1/2	1/2	3/16
-	M1E11	11/32	1	1/2	1/2	3/16
-	M1E12	3/8	1	5/8	5/8	1/4
-	M1E14	7/16	1	11/16	11/16	9/32
-	M1E16	1/2	1	11/16	11/16	11/32

*Sockets for predrilled holes are intermediate hardness; sockets for self-drilling and tapping screws are maximum hardness.

6 Point & 6 Point Magnetic, for Self-Drilling and Tapping Screws*

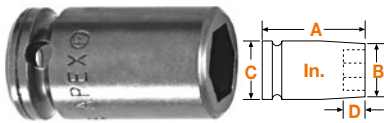

Part Number 6 Point	Part Number Magnetic	Hex Opening In.	Overall Length (A)	Diameter Nose End (B)	Diameter Drive End (C)	Opening Depth (D)
1P06	M1P06	3/16	7/8	5/16	1/2	3/32
1P07	M1P07	7/32	7/8	3/8	1/2	5/32
1P08	M1P08	1/4	7/8	7/16	1/2	5/32
-	M1P09	9/32	7/8	1/2	1/2	3/16
1P10	M1P10	5/16	7/8	1/2	1/2	3/16
1P11	M1P11	11/32	1	1/2	1/2	3/16
1P12	M1P12	3/8	1	5/8	5/8	1/4
1P14	M1P14	7/16	1	11/16	11/16	9/32
1P16	M1P16	1/2	1	11/16	11/16	11/32

*Sockets for predrilled holes are intermediate hardness; sockets for self-drilling and tapping screws are maximum hardness.

1/4" Square Drive Sockets for SAE Square Nuts

Single Square & Double Square



Part Number Square	Part No. Double Square	Hex Opening In.	Overall Length (A)	Diameter Nose End (B)	Diameter Drive End (C)	Opening Depth (D)
1608	1608-D	1/4	1	1/2	1/2	3/16
1612	1612-D	3/8	1	3/4	3/4	1/4

1/4" Square Drive Universal Wrenches, SAE

6 Point and Double Hex

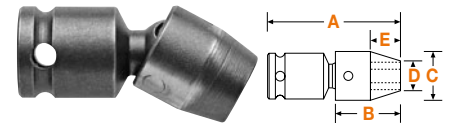

Part Number 6 Point	Part Number Double Hex	Hex Opening In.	Overall Length (A)	Socket Length (B)	Socket Diameter (C)	Nose End Diameter (D)	Clearance Depth (E)
SA-25	SA-25-D	1/4	1 7/32	3/4	5/8	3/8	3/8
SA-26	SA-26-D	5/16	1 17/32	3/4	5/8	7/16	3/8
SA-28	SA-28-D	3/8	1 19/32	13/16	5/8	17/32	7/16
SA-29	SA-29-D	7/16	1 21/32	7/8	5/8	5/8	1/2
SA-30	SA-30-D	1/2	1 21/32	7/8	11/16	11/16	1/2
SA-65	-	9/16	1 21/32	7/8	11/16	11/16	1/2

Universal wrenches must not be used with impact drivers.
Maximum operating angle is 30°.

1/4" Square Drive Sockets, Metric

Standard Length, 6 Point and Double Hex



Part Number 6 Point	Part Number Double Hex	Hex Opening mm	Overall Length (A)	Diameter Nose End (B)	Diameter Drive End (C)	Opening Depth (D)
3.5MM11	-	3.5	22.2	6.4	12.7	2.4
4MM11	-	4	22.2	6.4	12.7	2.4
4.5MM11	-	4.5	22.2	7.9	12.7	2.4
5MM11	-	5	22.2	8.7	12.7	3.9
5.5MM11	-	5.5	22.2	9.5	12.7	3.9
6MM11	6MM11-D	6	22.2	9.5	12.7	3.9
7MM11	7MM11-D	7	22.2	11.1	12.7	4.8
8MM11	8MM11-D	8	25.4	12.7	12.7	4.8
9MM11	9MM11-D	9	25.4	14.3	14.3	4.8
10MM11	10MM11-D	10	25.4	15.9	15.9	6.4
OS-10MM11	-	10	25.4	14.3	14.3	6.4
11MM11	11MM11-D	11	25.4	15.9	15.9	7.2
12MM11	12MM11-D	12	25.4	17.5	17.5	7.2
13MM11	13MM11-D	13	25.4	19.1	19.1	8.7
14MM11	14MM11-D	14	25.4	20.6	20.6	11.1
15MM11	-	15	25.4	22.2	22.2	11.1
16MM11	-	16	25.4	22.2	22.2	11.1

Magnetic, Standard Length, 6 Point

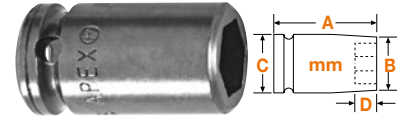

Part Number Fixed Magnet	Hex Opening mm	Overall Length (A)	Diameter Nose End (B)	Diameter Drive End (C)	Opening Depth (D)
M-5MM11	5	22.2	8.7	12.7	3.9
M-5.5MM11	5.5	22.2	9.5	12.7	3.9
M-6MM11	6	22.2	9.5	12.7	3.9
M-7MM11	7	22.2	11.9	12.7	4.8
M-8MM11	8	25.4	12.7	12.7	4.8
M-9MM11	9	25.4	14.3	14.3	4.8
M-10MM11	10	25.4	15.9	15.9	6.4
M-11MM11	11	25.4	15.9	15.9	7.2
M-12MM11	12	25.4	17.5	17.5	7.2
M-13MM11	13	25.4	19.1	19.1	8.7
M-14MM11	14	25.4	20.6	20.6	11.1
M-15MM11	15	25.4	22.2	22.2	11.1

Long Length, 6 Point and Double Hex



Part Number 6 Point	Part Number Double Hex	Hex Opening mm	Overall Length (A)	Diameter Nose End (B)	Diameter Drive End (C)	Opening Depth (D)
5MM21	-	5	44.4	8.7	12.7	3.9
5.5MM21	-	5.5	44.4	9.5	12.7	3.9
6MM21	-	6	44.4	9.5	12.7	3.9
7MM21	-	7	44.4	11.1	12.7	4.8
8MM21	8MM21-D	8	44.4	12.7	12.7	4.8
9MM21	9MM21-D	9	44.4	14.3	14.3	4.8
10MM21	10MM21-D	10	44.4	15.9	15.9	6.4
11MM21	-	11	44.4	15.9	15.9	7.2
12MM21	-	12	44.4	17.5	17.5	7.2
13MM21	13MM21-D	13	44.4	19.1	19.1	8.7
14MM21	-	14	44.4	20.6	20.6	11.1
15MM21	15MM21-D	15	50.8	22.2	22.2	11.1
16MM21	-	16	50.8	22.2	22.2	11.1

Magnetic, Long Length, 6 Point



Part No. Fixed Magnet	Part No. Magnetic Bolt Clearance	Hex Opening mm	Overall Length (A)	Diameter Nose End (B)	Diameter Drive End (C)	Opening Depth (D)
-	MB-5MM21	5	44.4	8.7	12.7	3.9
-	MB-5.5MM21	5.5	44.4	9.5	12.7	3.9
M-6MM21	MB-6MM21	6	44.4	9.5	12.7	3.9
M-7MM21	MB-7MM21	7	44.4	11.9	12.7	4.8
M-8MM21	MB-8MM21	8	44.4	12.7	12.7	4.8
M-9MM21	MB-9MM21	9	44.4	14.3	14.3	4.8
M-10MM21	MB-10MM21	10	44.4	15.9	15.9	6.4
-	**OSMB-10MM21	10	44.4	14.2	14.2	6.4
M-11MM21	MB-11MM21	11	44.4	15.9	15.9	7.2
M-12MM21	MB-12MM21	12	44.4	17.5	17.5	7.2
M-13MM21	MB-13MM21	13	44.4	19.1	19.1	8.7
-	MB-14MM21	14	44.4	20.6	20.6	11.1
-	MB-15MM21	15	50.8	22.2	22.2	11.1
-	MB-16MM21	16	50.8	22.2	22.2	11.1

* For an explanation of magnets, see Tool Tip on page 33.
** No ring groove.

Surface Drive, Standard and Long Length



Part Number Surface Drive	Hex Opening mm	Overall Length (A)	Diameter Nose End (B)	Diameter Drive End (C)	Opening Depth (D)
SF-8MM11	8	25.4	12.7	12.7	4.7
SF-10MM11	10	25.4	15.9	15.9	6.4
SF-10MM21	10	44.4	15.9	15.9	6.4
SF-12MM21	11	44.4	17.5	15.9	7.2
SF-13MM11	13	25.4	19.1	19.1	8.7
SF-13MM21	13	44.4	19.1	19.1	8.7
SF-15MM11	15	25.4	22.2	22.2	11.1

1/4" Square Drive Sockets For Metric Sheet Metal Screws

6 Point and 6 Point Magnetic



Part Number	Part Number magnetic	Hex Opening mm	Overall Length (A)	Diameter Nose End (B)	Diameter Drive End (C)	Opening Depth (D)
3,5MME1	-	3,5	22,2	6,4	12,7	2,4
4MME1	M-4MME1	4	22,2	6,4	12,7	2,4
-	M-5MME1	5	22,2	8,7	12,7	3,9
5,5MME1	M-5,5MME1	5,5	22,2	9,5	12,7	3,9
6MME1	M-6MME1	6	22,2	9,5	12,7	3,9
7MME1	M-7MME1	7	22,2	11,1	12,7	4,8
-	MR-7MME1*	7	22,2	11,1	12,7	4,8
8MME1	M-8MME1	8	25,4	12,7	12,7	4,8
9MME1	M-9MME1	9	25,4	14,3	14,3	4,8
10MME1	M-10MME1	10	25,4	15,9	15,9	6,4
11MME1	M-11MME1	11	25,4	17,5	17,5	7,2
12MME1	M-12MME1	12	25,4	17,5	17,5	7,2
13MME1	M-13MME1	13	25,4	19,1	19,1	8,7

*MR-7mmE1 has stronger magnet

1/4" Square Drive Sockets For Spline Fasteners

Standard and Long Length

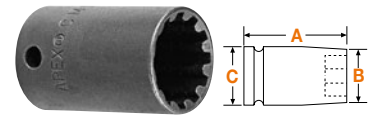

Part Number	Spline Size	Nominal Size	Overall Length (A)		Diameter Nose End (B)		Diameter Drive End (C)	
			In.	mm	In.	mm	In.	mm
CMS-1507	7	7/32	2	51	21/64	8	7/16	11
CMS-1408	8	1/4	7/8	22	3/8	10	7/16	11
CMS-1508	8	1/4	2	51	3/8	10	7/16	11
CMS-1409	9	9/32	7/8	22	7/16	11	7/16	11
CMS-1509	9	9/32	2	51	7/16	11	7/16	11
CMS-1410	10	5/16	7/8	22	29/64	12	29/64	12
CMS-1510	10	5/16	2	51	29/64	12	29/64	12
CMS-1412	12	3/8	7/8	22	17/32	14	17/32	14
CMS-1414	14	7/16	1	25	39/64	16	39/64	16

Apex spline sockets conform to military specifications MS-37787 and MIL-W-8982C.

1/4" Square Drive Universal Wrenches, Metric

6 Point

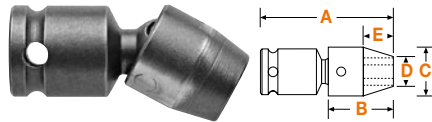

Part Number	Hex Opening mm	Overall Length (A)	Socket Length (B)	Socket Diameter (C)	Nose End Diameter (D)	Opening Depth (E)
SA-15-6M	6	31	19,1	15,9	9,5	9,5
SA-15-7M	7	31	19,1	15,9	10,3	9,5
SA-16-8M	8	38	19,1	19,1	11,1	7,9
SA-16-10M	10	40	20,6	19,1	15,1	9,5

Universal wrenches must not be used with impact drivers. Maximum operating angle is 30°.-

If the tool you need does not appear in this catalog, give us a call. The odds are, we may have what you need as a non-catalog item. If not, our experienced staff of tooling experts can design and manufacture "specials" to meet the needs of your specific application.

Give us a call at +49 7363-81-129 or visit our website www.apexpowertools.eu.

1/4" Square Drive Torx® Sockets

For External Torx Screws



Part Number	Driver Size	Overall Length (A)		Nose End Diameter (B)		Drive End Diameter (C)	
		In.	mm	In.	mm	In.	mm
TX-1104	E-4	1	25,4	1/4	6,4	1/2	12,7
TX-1105	E-5	1	25,4	1/4	6,4	1/2	12,7
TX-1106	E-6	1	25,4	5/16	7,9	1/2	12,7
TX-1108	E-8	1	25,4	3/8	9,5	1/2	12,7
TX-1110	E-10	1	25,4	9/16	14,3	9/16	14,3
TX-1112	E-12	1	25,4	5/8	15,9	5/8	15,9

For External Torx Screws, Thin Wall

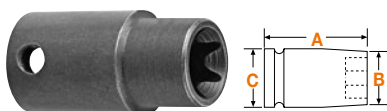

Part Number	Driver Size	Overall Length (A)		Nose End Diameter (B)		Drive End Diameter (C)	
		In.	mm	In.	mm	In.	mm
TX-1404	E-4	1	25,4	1/4	6,4	1/2	12,7
TX-1405	E-5	1	25,4	1/4	6,4	1/2	12,7
TX-1406	E-6	1	25,4	5/16	7,9	1/2	12,7
TX-1407	E-7	1	25,4	5/16	7,9	1/2	12,7
TX-1408	E-8	1	25,4	3/8	9,5	1/2	12,7
TX-1410	E-10	1	25,4	1/2	12,7	1/2	12,7
TX-1411	E-11	1	25,4	1/2	12,7	1/2	12,7
TX-1412	E-12	1	25,4	9/16	14,3	9/16	14,3

For Torx Nuts



Part Number	Driver Size	Overall Length (A)		Nose End Diameter (B)		Drive End Diameter (C)	
		In.	mm	In.	mm	In.	mm
TX-1E05	E-5	7/8	22,2	3/8	9,5	1/2	12,7
TX-1E06	E-6	7/8	22,2	7/16	11,1	1/2	12,7
TX-1E08	E-8	7/8	22,2	1/2	12,7	1/2	12,7

Sockets for Torx® nuts have a larger lead-in chamfer than sockets for external Torx® screws. Most Torx® sockets have a DIN (pin and o-ring) groove.

1/4" Square Drive Extensions

7/8" to 14"
(22mm to 356mm)
Length



Part Number	Male Square In.	Type of Lock	Overall Length	
			In.	mm
EX-252	1/4	Pin	7/8	22
EX-252-B	1/4	Ball	1	25
EX-255-2	1/4	Pin	2	51
EX-255-B-2	1/4	Ball	2	51
EX-255-3	1/4	Pin	3	76
EX-255-4	1/4	Pin	4	102
EX-255-B-4	1/4	Ball	4	102
EX-255-6	1/4	Pin	6	152
EX-255-B-6	1/4	Ball	6	152
EX-255-8	1/4	Pin	8	203
EX-255-10	1/4	Pin	10	254
EX-255-12	1/4	Pin	12	305
EX-255-14	1/4	Pin	14	356

1/4" Square Drive Adapters



1/4" to 3/8" Male Square

Part	Male Square In.	Female Square In.	Type of Lock	Overall Length	
				In.	mm
EX-372	3/8	1/4	Pin	1	25
EX-372-B	3/8	1/4	Ball	1	25

1/4" Square Drive Universal Adapters



Male Square to Female Square

Part	Male Square In.	Female Square In.	Type of Lock	Overall Length		Largest Diameter	
				In.	mm	In.	mm
MF-25	1/4	1/4	Pin	1 5/8	41	5/8	16
MF-25-B	1/4	1/4	Ball	1 5/8	41	5/8	16

Universal wrenches must not be used with impact drivers. Maximum operating angle is 30°.

3/8" Square Drive Sockets, SAE

6 Point & Double Hex, Short and Standard Length

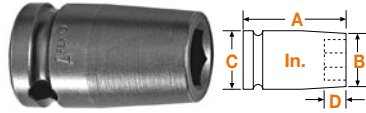

Part Number 6 Point	Part Number Double Hex	Hex Opening In.	Overall Length (A)	Diameter Nose End (B)	Diameter Drive End (C)	Opening Depth (D)
3108	3108-D	1/4	1 1/4	7/16	3/4	5/32
3109	-	9/32	1 1/4	7/16	3/4	3/16
3010	-	5/16	7/8	1/2	3/4	3/16
3110	3110-D	5/16	1 1/4	1/2	3/4	3/16
3111	-	11/32	1 1/4	1/2	3/4	3/16
3012	3012-D	3/8	7/8	19/32	3/4	3/16
3112	3112-D	3/8	1 1/4	19/32	3/4	1/4
3113	3113-D	13/32	1 1/2	11/16	3/4	1/4
3014	3014-D	7/16	7/8	11/16	3/4	9/32
3114	3114-D	7/16	1 1/2	11/16	3/4	9/32
SW-604	-	7/16	1 1/2	21/32	3/4	9/32
3016	3016-D	1/2	7/8	13/16	13/16	5/16
3116	3116-D	1/2	1 1/2	13/16	13/16	11/32
HC-3816	-	1/2	1 1/2	11/16	11/16	11/32
3117	-	17/32	1 1/2	13/16	13/16	11/32
3018	3018-D	9/16	7/8	7/8	7/8	5/16
3118	-	9/16	1 1/2	7/8	7/8	7/16
SW-343	-	9/16	1 1/2	3/4	3/4	7/16
SW-605	SW-605-D	9/16	1 1/2	3/4	13/16	7/16
3119	-	19/32	1 1/2	7/8	7/8	7/16
3020	3020-D	5/8	1	15/16	15/16	7/16
3120	3120-D	5/8	1 1/2	15/16	15/16	7/16
HC-3520*	-	5/8	2 3/8	7/8	7/8	7/32
3022	3022-D	11/16	1	1	1	7/16
3122	-	11/16	1 1/2	1	1	7/16
3024	3024-D	3/4	1	1 1/16	1 1/16	7/16
3124	3124-D	3/4	1 1/2	1 1/16	1 1/16	15/32
3126	-	13/16	1 1/2	1 1/8	1 1/8	7/16
3028	3028-D	7/8	1	1 1/4	1 1/4	7/16

*HC-3520 is spark plug socket.

6 Point & Double Hex, Thin Wall, Standard Length



Part Number 6 Point	Part Number Double Hex	Hex Opening In.	Overall Length (A)	Diameter Nose End (B)	Diameter Drive End (C)	Opening Depth (D)
3408	3408-D	1/4	1 1/4	7/16	3/4	5/32
3409	-	9/32	1 1/4	7/16	3/4	3/16
3410	3410-D	5/16	1 1/4	1/2	3/4	3/16
OS-3410*	-	5/16	1 1/4	7/16	19/32	3/16
3412	3412-D	3/8	1 1/2	19/32	3/4	1/4
3414	3414-D	7/16	1 1/2	5/8	3/4	9/32
3416	3416-D	1/2	1 1/2	3/4	3/4	11/32
3418	3418-D	9/16	1 1/2	25/32	13/16	7/16
3420	3420-D	5/8	1 1/2	7/8	7/8	7/16
3424	3424-D	3/4	1 1/2	1	1	15/32
3426	-	13/16	1 1/2	1 1/8	1 1/8	17/32
3428	-	7/8	1 1/2	1 3/16	1 1/4	9/16
3430	3430-D	15/16	1 1/2	1 5/16	1 5/16	5/8
3432	-	1	1 1/2	1 3/8	1 3/8	5/8
3434	-	1 1/16	1 1/2	1 1/2	1 1/2	11/16

*No ring groove.

6 Point & Double Hex, Long and Extra Long Length



Part Number 6 Point	Part Number Double Hex	Hex Opening In.	Overall Length (A)	Diameter Nose End (B)	Diameter Drive End (C)	Opening Depth (D)
3208	3208-D	1/4	2	7/16	3/4	5/32
3308	-	1/4	3 1/2	7/16	3/4	5/32
3209	-	9/32	2	7/16	3/4	3/16
3210	3210-D	5/16	2	1/2	3/4	3/16
3310	3310-D	5/16	3 1/2	1/2	3/4	3/16
OS-3310-D*	-	5/16	3 1/2	15/32	5/8	3/16
3211	-	11/32	2	1/2	3/4	3/16
3311	-	11/32	3 1/2	1/2	3/4	3/16
3212	3212-D	3/8	2	19/32	3/4	1/4
3312	3312-D	3/8	3 1/2	19/32	3/4	1/4
3214	3214-D	7/16	2	11/16	3/4	9/32
3314	3314-D	7/16	3 1/2	11/16	3/4	9/32
3216	3216-D	1/2	2	13/16	13/16	11/32
3316	3316-D	1/2	3 1/2	13/16	13/16	11/32
3218	3218-D	9/16	2	7/8	7/8	7/16
3318	3318-D	9/16	3 1/2	7/8	7/8	7/16
3220	3220-D	5/8	2	15/16	15/16	7/16
3320	3320-D	5/8	3 1/2	15/16	15/16	7/16
3222	3222-D	11/16	2	1	1	7/16
3322	3322-D	11/16	3 1/2	1	1	7/16
3224	3224-D	3/4	2	1 1/16	1 1/16	15/32
3324	3324-D	3/4	3 1/2	1 1/16	1 1/16	15/32
3226	3226-D	13/16	2	1 1/4	1 1/4	17/32
3326	3326-D	13/16	3 1/2	1 1/4	1 1/4	17/32
3228	3228-D	7/8	2	1 1/4	1 1/4	9/16
3328	-	7/8	3 1/2	1 1/4	1 1/4	9/16

*No ring groove.

6 Point & Double Hex, Thin Wall, Long Length



Part Number 6 Point	Part Number Double Hex	Hex Opening In.	Overall Length (A)	Diameter Nose End (B)	Diameter Drive End (C)	Opening Depth (D)
3510	-	5/16	2	1/2	3/4	3/16
3511	-	11/32	2	1/2	3/4	3/16
3512	3512-D	3/8	2	19/32	3/4	1/4
3514	3514-D	7/16	2	5/8	3/4	9/32
3516	3516-D	1/2	2	3/4	3/4	11/32
3518	3518-D	9/16	2	25/32	13/16	7/16
3524	3524-D	3/4	2	1	1	15/32
3530	-	15/16	2	1 5/16	1 5/16	5/8
3532	-	1	2	1 3/8	1 3/8	5/8
3534	-	1 1/16	2	1 1/2	1 1/2	11/16

3/8" Square Drive Sockets, SAE

Magnetic, Short and Standard Length

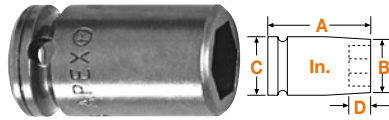

Part Number Fixed Magnet	Hex Opening In.	Overall Length (A)	Diameter Nose End (B)	Diameter Drive End (C)	Opening Depth (D)
M-3108	1/4	1 1/4	7/16	3/4	5/32
M-3109	9/32	1 1/4	7/16	3/4	3/16
M-3110	5/16	1 1/4	1/2	3/4	3/16
M-3012	3/8	7/8	19/32	3/4	3/16
M-3112	3/8	1 1/4	19/32	3/4	1/4
M-3014	7/16	7/8	11/16	3/4	9/32
M-3114	7/16	1 1/2	11/16	3/4	9/32
MSW-604	7/16	1 1/2	21/32	3/4	9/32
M-3016	1/2	7/8	13/16	13/16	5/16
M-3116	1/2	1 1/2	13/16	13/16	11/32
MHC-3816	1/2	1 1/2	11/16	11/16	11/32
M-3018	9/16	7/8	7/8	7/8	5/16
M-3118	9/16	1 1/2	7/8	7/8	7/16
MSW-343	9/16	1 1/2	3/4	3/4	7/16
M-3120	5/8	1 1/2	15/16	15/16	7/16

Magnetic, Thin Wall, Standard Length



Part Number Fixed Magnet	Hex Opening In.	Overall Length (A)	Diameter Nose End (B)	Diameter Drive End (C)	Opening Depth (D)
M-3408	1/4	1 1/4	7/16	3/4	5/32
M-3410	5/16	1 1/4	1/2	3/4	3/16
OSM-3410*	5/16	1 1/4	7/16	19/32	3/16
M-3411	11/32	1 1/4	1/2	3/4	3/16
M-3412	3/8	1 1/2	19/32	3/4	1/4
M-3414	7/16	1 1/2	5/8	3/4	9/32
OSM-3414*	7/16	1 1/2	5/8	5/8	9/32
M-3416	1/2	1 1/2	3/4	3/4	11/32
M-3418	9/16	1 1/2	25/32	13/16	7/16
M-3424	3/4	1 1/2	1	1	15/32
M-3426	13/16	1 1/2	1 1/8	1 1/8	17/32

*No ring groove.

Magnetic, Long Length & Extra Long Length



Part Number Fixed Magnet	Part Number Magnetic Bolt Clearance	Hex Opening In.	Overall Length (A)	Diameter Nose End (B)	Diameter Drive End (C)	Opening Depth (D)
-	MB-3210	5/16	2	1/2	3/4	3/16
M-3212	MB-3212	3/8	2	19/32	3/4	1/4
M-3214	MB-3214	7/16	2	11/16	3/4	9/32
-	MB-3314	7/16	3 1/2	11/16	3/4	9/32
M-3216	MB-3216	1/2	2	13/16	13/16	11/32
M-3218	MB-3218	9/16	2	7/8	7/8	7/16
-	MB-3318	9/16	3 1/2	7/8	7/8	7/16
-	MB-3220	5/8	2	15/16	15/16	7/16

Magnetic, Thin Wall, Long Length



Part Number Fixed Magnet	Part Number Magnetic Bolt Clearance	Hex Opening In.	Overall Length (A)	Diameter Nose End (B)	Diameter Drive End (C)	Opening Depth (D)
-	MB-3512	3/8	2	19/32	3/4	1/4
M-3514	MB-3514	7/16	2	5/8	3/4	9/32
-	MB-3516	1/2	2	3/4	3/4	11/32

Surface Drive & Fast Lead, Short and Standard Length

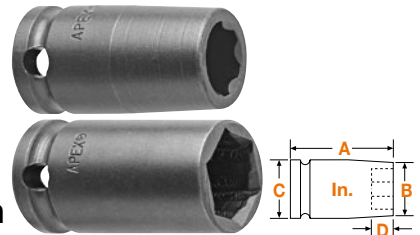

Part Number Surface- Drive	Part Number Fast Lead	Hex Opening In.	Overall Length (A)	Diameter Nose End (B)	Diameter Drive End (C)	Opening Depth (D)
SF-3010	-	5/16	7/8	1/2	3/4	3/16
SF-3110	FL-3110	5/16	1 1/4	1/2	3/4	3/16
SF-3012	FL-3012	3/8	7/8	19/32	3/4	3/16
SF-3112	FL-3112	3/8	1 1/4	19/32	3/4	1/4
SF-3014	FL-3014	7/16	7/8	11/16	3/4	9/32
SF-3114	FL-3114	7/16	1 1/2	11/16	3/4	9/32
SF-3016	FL-3016	1/2	7/8	13/16	13/16	5/16
SF-3116	FL-3116	1/2	1 1/2	13/16	13/16	11/32
SF-HC-3816	-	1/2	1 1/2	11/16	11/16	11/32
SF-3018	FL-3018	9/16	7/8	7/8	7/8	5/16
SF-3118	FL-3118	9/16	1 1/2	7/8	7/8	7/16
SF-3120	FL-3120	5/8	1 1/2	15/16	15/16	7/16
-	FL-3022	11/16	1	15/16	15/16	7/16
-	FL-3122	11/16	1 1/2	1	1	7/16
-	FL-3024	3/4	1	1 1/16	1 1/16	7/16
-	FL-3124	3/4	1 1/2	1 1/16	1 1/16	15/32

Surface Drive & Fast Lead, Thin Wall, Standard Length

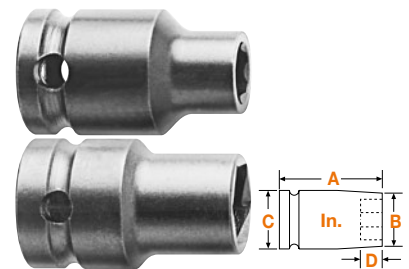

Part Number Surface- Drive	Part Number Fast Lead	Hex Opening In.	Overall Length (A)	Diameter Nose End (B)	Diameter Drive End (C)	Opening Depth (D)
SF-3412	FL-3412	3/8	1 1/2	19/32	3/4	1/4
SF-3414	FL-3414	7/16	1 1/2	5/8	3/4	9/32
SF-3416	-	1/2	1 1/2	3/4	3/4	11/32
SF-3418	-	9/16	1 1/2	25/32	13/16	7/16
SF-3432	-	1	1 1/2	1 3/8	1 3/8	5/8

3/8" Square Drive Sockets, SAE

Surface Drive & Fast Lead, Long and Extra Long Length

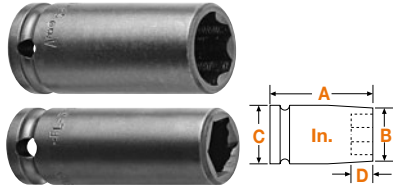

Part Number Surface-Drive	Part Number Fast Lead	Hex Opening In.	Overall Length (A)	Diameter Nose End (B)	Diameter Drive End (C)	Opening Depth (D)
-	FL-3210	5/16	2	1/2	3/4	3/16
SF-3212	FL-3212	3/8	2	19/32	3/4	1/4
-	FL-3312	3/8	3 1/2	19/32	3/4	1/4
SF-3214	FL-3214	7/16	2	11/16	3/4	9/32
SF-3314	FL-3314	7/16	3 1/2	11/16	3/4	9/32
SF-3216	FL-3216	1/2	2	13/16	13/16	11/32
SF-3316	FL-3316	1/2	3 1/2	13/16	13/16	11/32
SF-3218	FL-3218	9/16	2	7/8	7/8	7/16
SF-3318	FL-3318	9/16	3 1/2	7/8	7/8	7/16
-	FL-3220	5/8	2	15/16	15/16	7/16
SF-3320	FL-3320	5/8	3 1/2	15/16	15/16	7/16
SF-3224	-	3/4	2	1 1/16	1 1/16	15/32
SF-3324	FL-3324	3/4	3 1/2	1 1/16	1 1/16	15/32
-	FL-3326	13/16	3 1/2	1 1/4	1 1/4	17/32

Surface Drive, Thin Wall, Long Length



Part Number Surface-Drive	Hex Opening In.	Overall Length (A)	Diameter Nose End (B)	Diameter Drive End (C)	Opening Depth (D)
SF-3512	3/8	2	19/32	3/4	1/4
OSSF-3512*	3/8	2	19/32	19/32	1/4
SF-3514	7/16	2	5/8	3/4	9/32
OSSF-3514*	7/16	2	5/8	5/8	9/32
SF-3516	1/2	2	3/4	3/4	11/32
SF-3518	9/16	2	25/32	13/16	7/16

*No ring groove.

3/8" Square Drive Sockets For SAE Sheet Metal Screws

6 Point & 6 Point Magnetic, For Predrilled Holes*

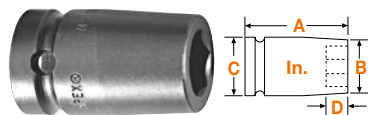

Part Number Non Magnetic	Part Number Magnetic	Hex Opening In.	Overall Length (A)	Diameter Nose End (B)	Diameter Drive End (C)	Opening Depth (D)
-	M3E08	1/4	1 1/4	7/16	3/4	5/32
3E10	M3E10	5/16	1 1/4	1/2	3/4	3/16
3E11	-	11/32	1 1/4	1/2	3/4	3/16
3E12	M3E12	3/8	1 1/4	19/32	3/4	1/4
3E14	M3E14	7/16	1 1/4	11/16	3/4	9/32
3E16	M3E16	1/2	1 1/2	13/16	13/16	11/32
-	M3E18	9/16	1 1/2	7/8	7/8	7/16

*Sockets for predrilled holes are intermediate hardness, sockets for self-drilling and tapping screws are maximum hardness.

3/8" Square Drive Sockets For SAE Sheet Metal Screws

6 Point & 6 Point Magnetic, For Self-Tapping Screws*

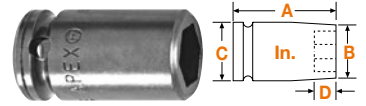

Part Number Non Magnetic	Part Number Magnetic	Hex Opening In.	Overall Length (A)	Diameter Nose End (B)	Diameter Drive End (C)	Opening Depth (D)
-	M3P06	3/16	1 1/4	5/16	3/4	3/32
-	M3P07	7/32	1 1/4	3/8	3/4	5/32
-	M3P08	1/4	1 1/4	7/16	3/4	5/32
3P10	M3P10	5/16	1 1/4	1/2	3/4	3/16
3P12	M3P12	3/8	1 1/4	5/8	3/4	1/4
3P14	M3P14	7/16	1 1/4	11/16	3/4	9/32
3P16	M3P16	1/2	1 1/2	13/16	13/16	11/32
-	M3P18	9/16	1 1/2	7/8	7/8	7/16

*Sockets for predrilled holes are intermediate hardness, sockets for self-drilling and tapping screws are maximum hardness.

3/8" Square Drive Sockets For SAE Square Nuts

Single Square & Double Square

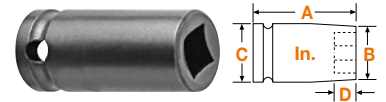

Part No. Single Square	Part No. Double Square	Hex Opening In.	Overall Length (A)	Diameter Nose End (B)	Diameter Drive End (C)	Opening Depth (D)
3607	-	7/32	1 1/2	7/16	3/4	3/16
360	-	1/4	1 1/2	1/2	3/4	3/16
3609	3609-D	9/32	1 1/2	9/16	3/4	3/16
3610	3610-D	5/16	1 1/2	5/8	3/4	1/4
3612	3612-D	3/8	1 1/2	3/4	3/4	1/4
3614	3614-D	7/16	1 1/2	7/8	7/8	9/32
3616	3616-D	1/2	1 1/2	1	1	11/32
3618	3618-D	9/16	1 1/2	1	1	7/16
3620	-	5/8	1 1/2	1 1/8	1 1/8	7/16
3624	-	3/4	1 1/2	1 3/8	1 3/8	15/32

3/8" Sq. Drive Socket Sets, SAE

6 Point



APS38	8 pieces, standard length: 5/16, 3/8, 7/16, 1/2, 9/16, 5/8, 11/16, 3/4
APS38L	8 pieces, long length: 5/16, 3/8, 7/16, 1/2, 9/16, 5/8, 11/16, 3/4

3/8" Square Drive Universal Wrenches, SAE

6 Point & 12 Point

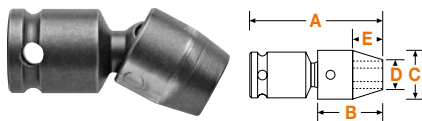

Part Number 6 Point	Part Number-12 Point	Hex Opening In.	Overall Length (A) In.	Socket Length (B) In.	Socket Diameter (C) In.	Nose End Diameter (D) In.	Clearance Depth (E) In.
SA-120	SA-120-D	5/16	1 53/64	3/4	3/4	7/16	5/16
SA-122	SA-122-D	3/8	1 57/64	13/16	3/4	9/16	3/8
SA-200	-	3/8	1 15/16	7/8	7/8	9/16	11/32
SA-123	SA-123-D	7/16	2 1/64	15/16	3/4	19/32	1/2
SA-201	-	7/16	2	15/16	7/8	5/8	13/32
SA-124	SA-124-D	1/2	2 5/64	1	3/4	3/4	9/16
SA-202	SA-202-D	1/2	2 1/16	1	7/8	11/16	15/32
SA-125	SA-125-D	9/16	2 1/8	1	13/16	13/16	9/16
SA-203	SA-203-D	9/16	2 1/16	1 1/16	7/8	3/4	17/32
SA-302	-	9/16	2 1/8	1 1/8	1	3/4	9/16
SA-205	SA-205-D	5/8	2 1/8	1 1/8	7/8	7/8	19/32
SA-305	-	11/16	2 5/16	1 1/4	1	1	11/16
SA-306	-	3/4	2 5/16	1 1/4	1 1/8	1 1/8	11/16

Universal wrenches must not be used with impact drivers. Maximum operating angle is 30°.

3/8" Square Drive IronBand™ Universal Wrenches, SAE

6 Point

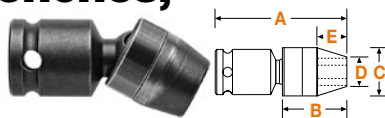

Part Number 6 Point	Part Number-12 Point	Hex Opening In.	Overall Length (A) In.	Socket Length (B) In.	Socket Diameter (C) In.	Nose End Diameter (D) In.	Clearance Depth (E) In.
SA-C-120	5/16	1,83	,75	,75	,44	,31	
SA-C-122	3/8	1,89	,81	,75	,56	,38	
SA-C-123	7/16	2,02	,94	,75	,59	,50	
SA-C-124	1/2	2,08	1,0	,75	,75	,56	
SA-C-205	5/8	2,13	1,13	,88	,88	,59	
SA-C-305	11/16	2,31	1,25	1,00	1,00	,69	
SA-C-306	3/4	2,31	1,25	1,13	1,13	,69	

Universal wrenches must not be used with impact drivers. Maximum operating angle is 30°.

3/8" Square Drive Universal Wrench Set, SAE

6 Point



APU37
7 pieces, standard length:
3/8, 7/16, 1/2, 9/16, 5/8, 11/16, 3/4

3/8" Square Drive Universal Wrenches, SAE - Extension

6 Point Standard and Tension Type



Part Number Standard	Part Number Tension	Hex Opening In.	Overall Length (A) In.	Socket Length (B) In.	Socket Dia. (C) In.	Nose End Dia. (D) In.	Clearance Depth (E) In.
KA-43-6	KD-43-6	3/8	6	13/16	5/8	17/32	7/16
KA-44-3	-	7/16	3	7/8	5/8	5/8	1/2
KA-44-4	-	7/16	4	7/8	5/8	5/8	1/2
KA-44-6	KD-44-6	7/16	6	7/8	5/8	5/8	1/2
KA-103-6	KD-103-6	7/16	6	15/16	3/4	19/32	1/2
KA-45-3	-	1/2	3	7/8	11/16	11/16	1/2
KA-45-4	-	1/2	4	7/8	11/16	11/16	1/2
KA-45-6	KD-45-6	1/2	6	7/8	11/16	11/16	1/2
KA-45-9	-	1/2	9	7/8	11/16	11/16	1/2
KA-104-9	-	1/2	9	1	3/4	3/4	9/16
-	KD-104-12	1/2	12	1	3/4	3/4	9/16
KA-105-3	KD-105-3	9/16	3	1	13/16	13/16	9/16
KA-105-4	-	9/16	4	1	13/16	13/16	9/16
KA-105-6	KD-105-6	9/16	6	1	13/16	13/16	9/16
KA-105-9	-	9/16	9	1	13/16	13/16	9/16
KA-205-3	-	5/8	3	1 1/8	7/8	7/8	19/32
-	KD-205-6	5/8	6	1 1/8	7/8	7/8	19/32

Universal wrenches must not be used with impact drivers. Maximum operating angle is 30°.

3/8" Sq. Drive IronBand™ Univ. Wrenches, SAE - Extension

6 Point Standard and Tension Type



Part Number Standard	Part Number Tension	Hex Opening In.	Overall Length (A) In.	Socket Length (B) In.	Socket Dia. (C) In.	Nose End Dia. (D) In.	Clearance Depth (E) In.
KAW-C-43-6	KDW-C-43-6	3/8	6	,81	,63	,53	,44
KAW-C-44-6	KDW-C-44-6	7/16	6	,88	,63	,63	,50
KAW-C-45-6	KDW-C-45-6	1/2	6	,88	,69	,69	,50
KAW-C-104-9	-	1/2	9	1,00	,75	,75	,56
-	KDW-C-104-12	1/2	12	1,00	,75	,75	,56
KAW-C-105-6	KDW-C-105-6	9/16	6	1,00	,81	,81	,56

Universal wrenches must not be used with impact drivers. Maximum operating angle is 30°.

3/8" Square Drive Socket Head Bits, SAE

Complete, Adapter Only, Insert Only

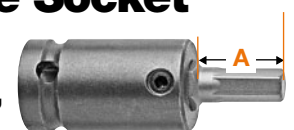

Complete	Part Number		Hex Size	Overall Length In.	Length of Insert (A) mm		
	Adapter Only	Insert Only					
SZ-10	SC-314	SZ-10-A	1/8	2 1/4	57	1 3/8	35
SZ-11	SC-314	SZ-11-A	5/32	2 1/4	57	1 3/8	35
SZ-12	SC-314	SZ-12-A	3/16	2 1/4	57	1 3/8	35
SZ-13	SC-314	SZ-13-A	7/32	2 1/4	57	1 3/8	35
SZ-14	SC-314	SZ-14-A	1/4	2 1/4	57	1 3/8	35
SZ-15	SC-314	SZ-15-A	5/16	2 1/4	57	1 3/8	35
SZ-16	SC-314	SZ-16-A	3/8	2 1/4	57	1 3/8	35

See page 35 for more 3/8" drive complete socket head bits.

3/8" Square Drive Sockets, Metric

6 Point & 12 Point, Short and Standard Length

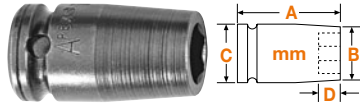

Part Number 6 Point	Part Number 12 Point	Hex Opening mm	Overall Length (A)	Diameter Nose End (B)	Diameter Drive End (C)	Opening Depth (D)
6MM13	-	6	31,7	11,1	19,1	3,9
7MM03	-	7	22,2	11,1	19,1	3,0
7MM13	-	7	31,7	11,1	19,1	4,8
8MM03	-	8	22,2	12,7	19,1	4,8
8MM13	8MM13-D	8	31,7	12,7	19,1	4,8
OS-8MM13*	-	8	31,7	11,7	15,7	4,8
9MM13	9MM13-D	9	31,7	15,1	19,1	4,8
10MM03	10MM03-D	10	22,2	16,8	19,1	6,4
OS-10MM03*	-	10	22,1	15,7	15,7	6,4
10MM13	10MM13-D	10	31,7	16,8	19,1	6,4
11MM03	11MM03-D	11	22,2	17,5	19,1	7,2
11MM13	11MM13-D	11	31,7	17,5	19,1	7,2
12MM03	12MM03-D	12	22,2	19,1	19,1	7,2
12MM13	12MM13-D	12	38,1	19,1	19,1	7,2
13MM03	13MM03-D	13	22,2	20,6	20,6	7,9
13MM13	13MM13-D	13	38,1	20,6	20,6	8,7
14MM03	14MM03-D	14	22,2	22,2	22,2	7,9
14MM13	14MM13-D	14	38,1	22,2	22,2	11,1
15MM03	15MM03-D	15	23,8	22,2	22,2	9,5
15MM13	15MM13-D	15	38,1	22,2	22,2	11,1
16MM03	16MM03-D	16	25,4	23,8	23,8	11,1
16MM13	16MM13-D	16	38,1	23,8	23,8	11,1
17MM03	-	17	25,4	25,4	25,4	11,1
17MM13	17MM13-D	17	38,1	25,4	25,4	11,1
18MM03	-	18	25,4	25,4	25,4	11,1
18MM13	18MM13-D	18	38,1	25,4	25,4	11,1
19MM03	19MM03-D	19	25,4	28,6	28,6	11,1
19MM13	19MM13-D	19	38,1	28,6	28,6	11,9
20MM03	-	20	25,4	28,6	28,6	11,1
21MM03	-	21	25,4	31,7	31,7	11,1
21MM13	-	21	38,1	31,7	31,7	13,5
22MM03	-	22	25,4	31,7	31,7	11,1
22MM13	-	22	38,1	31,7	31,7	14,3

*No ring groove.

6 Point & Double Hex, Thin Wall, Standard Length



Part Number 6 Point	Part Number 12 Point	Hex Opening mm	Overall Length (A)	Diameter Nose End (B)	Diameter Drive End (C)	Opening Depth (D)
6MM43	-	6	31,7	9,5	19,1	3,9
7MM43	7MM43-D	7	31,7	11,1	19,1	4,8
8MM43	8MM43-D	8	31,7	12,7	19,1	4,8
9MM43	9MM43-D	9	31,7	12,7	19,1	4,8
10MM43	10MM43-D	10	31,7	15,1	19,1	6,4
11MM43	-	11	38,1	15,9	19,1	7,2
12MM43	12MM43-D	12	38,1	17,5	19,1	7,2
13MM43	13MM43-D	13	38,1	19,1	19,1	8,7
14MM43	14MM43-D	14	38,1	19,8	20,6	11,1
15MM43	15MM43-D	15	38,1	20,6	20,6	11,1
16MM43	16MM43-D	16	38,1	22,2	22,2	11,1
17MM43	17MM43-D	17	38,1	23,8	23,8	11,1
18MM43	-	18	38,1	23,8	23,8	11,1
19MM43	19MM43-D	19	38,1	25,4	25,4	11,9

6 Point & Double Hex, Long and Extra Long Length



Part Number 6 Point	Part Number 12 Point	Hex Opening mm	Overall Length (A)	Diameter Nose End (B)	Diameter Drive End (C)	Opening Depth (D)
7MM23	-	7	50,8	11,1	19,1	4,8
8MM23	8MM23-D	8	50,8	12,7	19,1	4,8
9MM23	9MM23-D	9	50,8	15,1	19,1	4,8
10MM23	10MM23-D	10	50,8	16,8	19,1	6,4
OS-10MM23*	OS-10MM23-D*	10	50,8	14,2	15,9	6,4
10MM33	-	10	88,9	16,8	19,1	6,4
11MM23	11MM23-D	11	50,8	17,5	19,1	7,2
12MM23	12MM23-D	12	50,8	19,1	19,1	7,2
13MM23	13MM23-D	13	50,8	20,6	20,6	8,7
13MM33	-	13	88,9	20,6	20,6	8,7
14MM23	14MM23-D	14	50,8	22,2	22,2	11,1
15MM23	15MM23-D	15	50,8	22,2	22,2	11,1
15MM33	15MM33-D	15	88,9	22,2	22,2	11,1
16MM23	16MM23-D	16	50,8	23,8	23,8	11,1
17MM23	17MM23-D	17	50,8	25,4	25,4	11,1
18MM23	18MM23-D	18	50,8	25,4	25,4	11,1
19MM23	19MM23-D	19	50,8	28,6	28,6	11,9
21MM23	-	21	50,8	31,7	31,7	13,5
22MM23	-	22	50,8	31,7	31,7	14,3

*No ring groove.

Magnetic, Short & Standard Length



Part Number Fixed Magnet	Hex Opening mm	Overall Length (A)	Diameter Nose End (B)	Diameter Drive End (C)	Opening Depth (D)
M-6MM13	6	31,8	11,1	19,1	3,9
M-7MM13	7	31,8	11,1	19,1	4,8
M-8MM13	8	31,8	12,7	19,1	4,8
M-9MM13	9	31,8	15,1	19,1	4,8
M-10MM03	10	22,2	16,8	19,1	6,4
M-10MM13	10	31,8	16,8	19,1	6,4
M-11MM03	11	22,2	17,5	19,1	7,2
M-11MM13	11	31,7	17,5	19,1	7,2
M-12MM03	12	22,2	19,1	19,1	7,2
M-12MM13	12	38,1	19,1	19,1	7,2
M-13MM03	13	22,2	20,6	20,6	8,7
M-13MM13	13	38,1	20,6	20,6	8,7
M-14MM13	14	38,1	22,2	22,2	11,1
M-15MM03	15	23,8	22,2	22,2	9,5
M-15MM13	15	38,1	22,2	22,2	11,1
M-16MM13	16	38,1	23,8	23,8	11,1
M-17MM13	17	38,1	25,4	25,4	11,1
M-18MM03	18	25,4	25,4	25,4	11,1
M-18MM13	18	38,1	25,4	25,4	11,1

3/8" Square Drive Sockets, Metric

Magnetic, Thin Wall, Standard Length

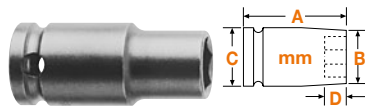

Part Number Fixed Magnet	Hex Opening mm	Overall Length (A)	Diameter Nose End (B)	Diameter Drive End (C)	Opening Depth (D)
M-8MM43	8	31,7	12,7	19,1	4,8
M-10MM43	10	31,7	15,1	19,1	6,4
M-11MM43	11	38,1	15,9	19,1	7,2
M-12MM43	12	38,1	17,5	19,1	7,2
M-13MM43	13	38,1	19,1	19,1	8,7
M-14MM43	14	38,1	19,8	20,6	11,1
M-15MM4	15	38,1	20,5	20,6	11,1

Surface Drive, Thin Wall, Standard Length

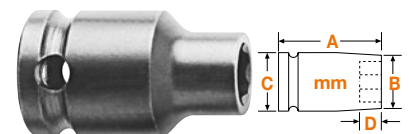

Part Number Surface- Drive	Hex Opening mm	Overall Length (A)	Diameter Nose End (B)	Diameter Drive End (C)	Opening Depth (D)
SF-10MM43	10	31,7	15,1	19,1	6,4
OSSF-10MM43*	10	31,7	15,1	15,1	6,4
SF-11MM43	11	38,1	15,9	19,1	7,2
SF-12MM43	12	38,1	17,5	19,1	7,2
SF-13MM43	13	38,1	19,1	19,1	8,7
SF-15MM43	15	38,1	20,6	20,6	11,1
SF-17MM43	17	38,1	23,8	23,8	11,1
SF-18MM43	18	38,1	23,8	23,8	11,1
SF-19MM43	19	38,1	25,4	25,4	11,9

*No ring groove.

Magnetic, Long & Extra Long Length



Part Number Fixed Magnet	Hex Opening mm	Overall Length (A)	Diameter Nose End (B)	Diameter Drive End (C)	Opening Depth (D)
MB-6MM23	6	50,8	11,1	19,1	3,9
MB-7MM23	7	50,8	11,1	19,1	4,8
MB-8MM23	8	50,8	12,7	19,1	4,8
OSMB-8MM23*	8	50,8	11,7	15,9	4,8
MB-9MM23	9	50,8	15,1	19,1	4,8
MB-10MM23	10	50,8	16,8	19,1	6,4
OSMB-10MM23*	10	50,8	14,2	15,9	6,4
MB-10MM33	10	88,9	16,8	19,1	6,4
MB-11MM23	11	50,8	17,5	19,1	7,2
MB-12MM23	12	50,8	19,1	19,1	7,2
MB-13MM23	13	50,8	20,6	20,6	8,7
MB-13MM33	13	88,9	20,6	20,6	8,7
MB-14MM23	14	50,8	22,2	22,2	11,1
MB-15MM23	15	50,8	22,2	22,2	11,1
MB-15MM33	15	88,9	22,2	22,2	11,1
MB-16MM23	16	50,8	23,8	23,8	11,1
MB-17MM23	17	50,8	25,4	25,4	11,1
MB-18MM2	18	50,8	25,4	25,4	11,1

*Ohne DIN Ring Nut.

Surface Drive, Long & Extra Long Length



Part Number Surface- Drive	Hex Opening mm	Overall Length (A)	Diameter Nose End (B)	Diameter Drive End (C)	Opening Depth (D)
SF-8MM23	8	50,8	12,7	19,1	4,8
OSSF-8MM23*	8	50,8	11,9	15,9	4,8
SF-10MM23	10	50,8	16,8	19,1	6,4
OSSF-10MM23*	10	50,8	14,2	15,9	6,4
SF-10MM33	10	88,9	16,8	19,1	6,4
SF-11MM23	11	50,8	17,5	19,1	7,2
SF-12MM23	12	50,8	19,1	19,1	7,2
SF-13MM23	13	50,8	20,6	20,6	8,7
SF-13MM33	13	88,9	20,6	20,6	8,7
SF-15MM23	15	50,8	22,2	22,2	11,1
SF-15MM33	15	88,9	22,2	22,2	11,1
SF-17MM23	17	50,8	25,4	25,4	11,1
SF-18MM23	18	50,8	25,4	25,4	11,1
SF-19MM23	19	50,8	28,6	28,6	11,9

*No ring groove.

Surface Drive, Short and Standard Length

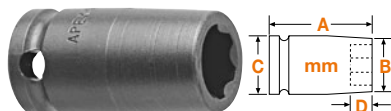

Part Number Fixed Magnet	Hex Opening mm	Overall Length (A)	Diameter Nose End (B)	Diameter Drive End (C)	Opening Depth (D)
SF-8MM13	8	31,7	12,7	19,1	4,8
SF-10MM03	10	22,2	16,8	19,1	6,4
SF-10MM13	10	31,7	16,8	19,1	6,4
SF-11MM13	11	31,7	17,5	19,1	7,2
SF-12MM03	12	22,2	19,1	19,1	7,2
SF-12MM13	12	38,1	19,1	19,1	7,2
SF-13MM03	13	22,2	20,6	20,6	8,7
SF-13MM13	13	38,1	20,6	20,6	8,7
SF-14MM13	14	38,1	22,2	22,2	11,1
SF-15MM03	15	23,8	22,2	22,2	11,1
SF-15MM13	15	38,1	22,2	22,2	11,1
SF-16MM13	16	38,1	23,8	23,8	11,1
SF-17MM03	17	25,4	25,4	25,4	11,1
SF-17MM13	17	38,1	25,4	25,4	11,1
SF-18MM13	18	38,1	25,4	25,4	11,1
SF-19MM13	18	38,1	28,6	28,6	11,9

3/8" Square Drive Sockets For Metric Sheet Metal Screws

6 Point & 6 Point Magnetic, for Predrilled Holes

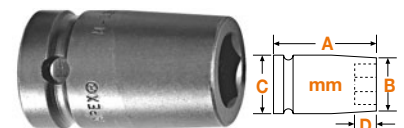

Part Number 6 Point	Part Number Magnetic	Hex Opening mm	Overall Length (A)	Diameter Nose End (B)	Diameter Drive End (C)	Opening Depth (D)
-	M-6MME3	6	31,7	11,1	19,1	3,9
-	M-7MME3	7	31,7	11,9	19,1	4,8
8MME3	M-8MME3	8	31,7	12,7	19,1	4,8
10MME3	M-10MME3	10	31,7	16,8	19,1	6,4
-	M-11MME3	11	31,7	17,5	19,1	7,2
13MME3	M-13MME3	13	38,1	20,6	20,6	8,7

3/8" Square Drive Socket Sets, Metric

6 Point



APS312M 12 pieces, standard length:
7mm, 8mm, 9mm, 10mm, 11mm, 12mm, 13mm, 14mm,
15mm, 16mm, 17mm, 18mm

APS312LM 12 pieces, long length:
7mm, 8mm, 9mm, 10mm, 11mm, 12mm, 13mm, 14mm,
15mm, 16mm, 17mm, 18mm

3/8" Square Drive IronBand™ Universal Wrenches, Metric

6 Point

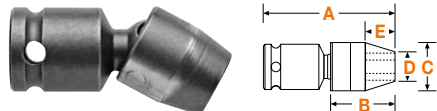

Part Number 6 Point	Hex Opening mm	Overall Length (A)	Socket Length (B)	Socket Diameter (C)	Nose End Diameter (D)	Clearance Depth (E)
SA-C-36-10M	10	48	20,6	19,1	15,1	9,5
SA-C-37-12M	12	51	23,8	22,2	17,5	10,3
SA-C-37-13M	13	52	25,4	22,2	17,5	11,9
SA-C-37-14M	14	54	27,0	22,2	19,1	13,5
SA-C-38-15M	15	56	28,6	25,4	19,8	14,3
SA-C-38-17M	17	59	31,8	25,4	25,4	17,5
SA-C-38-18M	18	59	31,8	25,4	25,4	17,5

Universal wrenches must not be used with impact drivers. Maximum operating angle is 30°.

3/8" Square Drive Universal Wrench Set, Metric

6 Point



APU37M 7 pieces, standard length:
10mm, 12mm, 13mm, 14mm, 15mm, 17mm, 18mm

3/8" Square Drive Universal Wrenches, Metric – Extension

6 Point Standard and Tension Type



Part Number Standard	Part Number Tension	Hex Opening mm	Shank Length (A) mm	Socket Length (B) mm	Socket Diameter (C) mm	Nose End Diameter (D) mm	Clearance Depth (E) mm
KA-6-10M-4	-	10	102	20,6	19,1	15,1	9,5
KA-6-10M-6	KD-6-10M-6	10	152	20,6	19,1	15,1	9,5
KA-6-10M-9	KD-6-10M-9	10	229	20,6	19,1	15,1	9,5
-	KD-6-10M-12	10	305	20,6	19,1	15,1	9,5
-	KD-7-11M-6	11	152	23,8	22,2	15,9	10,3
KA-7-11M-12	KD-7-11M-12	11	305	23,8	22,2	15,9	10,3
KA-7-12M-4	-	12	102	23,8	22,2	17,5	10,3
KA-7-12M-6	KD-7-12M-6	12	152	23,8	22,2	17,5	10,3
KA-7-12M-9	KD-7-12M-9	12	229	23,8	22,2	17,5	10,3
KA-7-12M-12	KD-7-12M-12	12	305	23,8	22,2	17,5	10,3
KA-7-13M-3	-	13	76	25,4	22,2	17,5	11,9
KA-7-13M-4	-	13	102	25,4	22,2	17,5	11,9
KA-7-13M-6	KD-7-13M-6	13	152	25,4	22,2	17,5	11,9
KA-7-13M-9	KD-7-13M-9	13	229	25,4	22,2	17,5	11,9
KA-7-13M-12	KD-7-13M-12	13	305	25,4	22,2	17,5	11,9
KA-7-14M-6	KD-7-14M-6	14	152	27,0	22,2	19,1	13,5
-	KD-7-14M-9	14	229	27,0	22,2	19,1	13,5
KA-8-15M-3	-	15	76	28,6	25,4	19,8	14,3
-	KD-8-15M-6	15	152	28,6	25,4	19,8	14,3
KA-8-15M-9	KD-8-15M-9	15	229	28,6	25,4	19,8	14,3
KA-8-15M-12	KD-8-15M-12	15	305	28,6	25,4	19,8	14,3

Universal wrenches must not be used with impact drivers. Maximum operating angle is 30°.

3/8" Square Drive IronBand™ Univ. Wrenches, Metric

6 Point Standard and Tension Type



Part Number Standard	Part Number Tension	Hex Opening mm	OA L. (A) mm	Soc. L (B) mm	Soc. Dia (C) mm	Nose Dia. (D) mm	Clear. Depth (E) mm
KAW-C-6-10M-6	KDW-C-6-10M-6	10	152	20,6	19,1	15,1	9,5
KAW-C-6-10M-9	KDW-C-6-10M-9	10	229	20,6	19,1	15,1	9,5
KAW-C-7-12M-6	KDW-C-7-12M-6	12	152	23,8	22,2	17,5	10,3
KAW-C-7-12M-12	KDW-C-7-12M-12	12	305	23,8	22,2	17,5	10,3
KAW-C-7-13M-6	KDW-C-7-13M-6	13	152	25,4	22,2	17,5	11,9
KAW-C-7-13M-12	KDW-C-7-13M-12	13	305	25,4	22,2	17,5	11,9
KAW-C-7-14M-6	KDW-C-7-14M-6	14	152	27,0	22,2	19,1	13,5
KAW-C-8-15M-9	KDW-C-8-15M-9	15	229	28,6	25,4	19,8	14,3

Universal wrenches must not be used with impact drivers. Maximum operating angle is 30°.

3/8" Square Drive Socket Head Bits, Metric

Complete, Adapter only, Insert Only

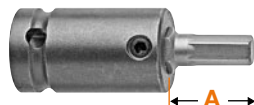

Complete	Part Number		Hex Size	Overall Length		Length of Insert(A)	
	Adapter Only	Insert Only		In.	mm	In.	mm
SZ-3-7-4MM	SC-314	SZ-7-4MM	4mm	2 1/4	57	1 3/8	35
SZ-3-7-5MM	SC-314	SZ-7-5MM	5mm	2 1/4	57	1 3/8	35
SZ-3-7-6MM	SC-314	SZ-7-6MM	6mm	2 1/4	57	1 3/8	35
SZ-3-7-8MM	SC-314	SZ-7-8MM	8mm	2 1/4	57	1 3/8	35
SZ-3-7-10MM	SC-314	SZ-7-10MM	10mm	2 1/4	57	1 3/8	35

See page 19 for more 3/8" drive complete socket head bits.

3/8" Square Drive Sockets For Spline Fasteners

Standard and Long Length

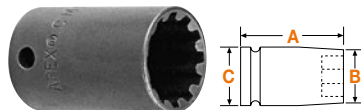

Part Number	Spline Size	Nominal Size	Overall Length (A)		Diameter Nose End (B)		Diameter Drive End (C)	
			In.	mm	In.	mm	In.	mm
CMS-3412	12	3/8	1	25	17/32	14	21/32	17
CMS-3512	12	3/8	2 1/8	54	17/32	14	21/32	17
CMS-3414	14	7/16	1 1/16	27	5/8	16	11/16	18
CMS-3416	16	1/2	1 1/16	27	23/32	18	23/32	18
CMS-3418	18	9/16	1 1/16	27	13/16	21	13/16	21
CMS-3518	18	9/16	2 3/8	60	13/16	21	13/16	21
CMS-3420	20	5/8	1 3/16	30	7/8	22	7/8	22

Apex spline sockets conform to military specifications MS-37787 and MIL-W-8982C.

3/8" Square Drive Torx® Sockets

For External Torx Screws



Part Number	Driver Size	Overall Length (A)		Nose End Diameter (B)		Drive End Diameter (C)	
		In.	mm	In.	mm	In.	mm
TX-3106	E-6	1 1/4	32	3/8	10	3/4	19
TX-3107	E-7	1 1/4	32	3/8	10	3/4	19
TX-3108	E-8	1 1/4	32	7/16	11	3/4	19
TX-3110	E-10	1 1/4	32	1/2	13	3/4	19
TX-3112	E-12	1 1/4	32	5/8	16	3/4	19
TX-3114	E-14	1 1/4	32	11/16	18	3/4	19
TX-3116	E-16	1 1/4	32	13/16	21	13/16	21

For External Torx Screws, Thin Wall

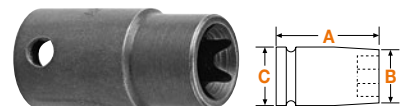

Part Number	Driver Size	Overall Length (A)		Nose End Diameter (B)		Drive End Diameter (C)	
		In.	mm	In.	mm	In.	mm
TX-3406	E-6	1 1/4	32	5/16	8	5/8	16
TX-3407	E-7	1 1/4	32	11/32	9	5/8	16
TX-3408	E-8	1 1/4	32	3/8	10	5/8	16
TX-3508	E-8	2	51	3/8	10	5/8	16
TX-3410	E-10	1 1/4	32	1/2	13	5/8	16
TX-3412	E-12	1 1/4	32	9/16	14	5/8	16
TX-3414	E-14	1 1/4	32	5/8	16	3/4	19

Some Torx® sockets have a DIN (pin and o-ring) groove.

For Torx Nuts

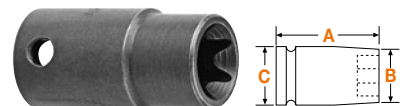

Part Number	Driver Size	Overall Length (A)		Nose End Diameter (B)		Drive End Diameter (C)	
		In.	mm	In.	mm	In.	mm
TX-3E08	E-8	1 1/4	32	5/8	16	5/8	16
TX-3E10	E-10	1 1/4	32	5/8	16	5/8	16

Sockets for Torx® nuts have a larger lead-in chamfer than sockets for external Torx® screws.

Most Torx® sockets have a DIN (pin and o-ring) groove.

3/8" Square Drive Extensions

1 1/4" to 18"
(32mm to 457mm)
Length



Part Number	Male Square In.	Type of Lock	Overall Length In.	Overall Length mm
EX-374	3/8	Pin	1 3/8	34
EX-374-B	3/8	Ball	1 3/8	34
EX-376-2	3/8	Pin	2	51
EX-376-B-2	3/8	Ball	2	51
EX-376-3	3/8	Pin	3	76
EX-376-B-3	3/8	Ball	3	76
EX-376-4	3/8	Pin	4	102
EX-376-B-4	3/8	Ball	4	102
EX-376-5	3/8	Pin	5	127
EX-376-B-5	3/8	Ball	5	127
EX-376-6	3/8	Pin	6	152
EX-376-B-6	3/8	Ball	6	152
EX-376-8	3/8	Pin	8	203
EX-376-B-8	3/8	Ball	8	203
EX-376-9	3/8	Pin	9	229
EX-376-B-9	3/8	Ball	9	229
EX-376-10	3/8	Pin	10	254
EX-376-B-10	3/8	Ball	10	254
EX-376-12	3/8	Pin	12	305
EX-376-B-12	3/8	Ball	12	305
EX-376-15	3/8	Pin	15	381
EX-376-B-15	3/8	Ball	15	381
EX-376-18	3/8	Pin	18	457

3/8" Square Drive Adapters

1/4" to 3/4"
Male Square



Part Number	Male Square In.	Female Square In.	Type of Lock	Overall Length In.	Overall Length mm
EX-254	1/4	3/8	Pin	1 1/4	32
EX-254-B	1/4	3/8	Ball	1 1/4	32
EX-257-2	1/4	3/8	Pin	2	51
EX-257-B-2	1/4	3/8	Ball	2	51
EX-257-3	1/4	3/8	Pin	3	76
EX-257-B-3	1/4	3/8	Ball	3	76
EX-257-4	1/4	3/8	Pin	4	102
EX-257-B-4	1/4	3/8	Ball	4	102
EX-257-5	1/4	3/8	Pin	5	127
EX-257-B-5	1/4	3/8	Ball	5	127
EX-257-6	1/4	3/8	Pin	6	152
EX-257-B-6	1/4	3/8	Ball	6	152
EX-503	1/2	3/8	Pin	1 1/2	38
EX-503-B	1/2	3/8	Ball	1 1/2	38
EX-507-2	1/2	3/8	Pin	2	51
EX-507-3	1/2	3/8	Pin	3	76
EX-507-B-3	1/2	3/8	Ball	3	76
EX-507-4	1/2	3/8	Pin	4	102
EX-507-B-4	1/2	3/8	Ball	4	102
EX-507-6	1/2	3/8	Pin	6	152
EX-507-B-6	1/2	3/8	Ball	6	152
EX-622	5/8	3/8	Pin	1 1/2	38
EX-750	3/4	3/8	7/32" Drill Hole	1 1/2	38
EX-750-B	3/4	3/8	Ball	1 1/2	38

3/8" Square Drive Universal Adapters

Male Square to Female Square



Part Number	Male Sq. In.	Female Sq. In.	Type of Lock	Overall Length In.	Overall Length mm	Largest Diameter In.	Largest Diameter mm
MF-27	1/4	3/8	Pin	1 5/16	49	3/4	19
MF-27-B	1/4	3/8	Ball	1 5/16	49	3/4	19
MF-37	3/8	3/8	Pin	2 1/8	54	3/4	19
MF-37-B	3/8	3/8	Ball	2 1/8	54	3/4	19
MF-38-B	3/8	3/8	Ball	2 1/2	64	7/8	22

*Universal wrenches must not be used with impact drivers.
Maximum operating angle is 30°.*

3/8" Square Drive Universal Adapters - Extension

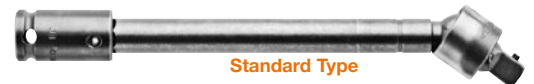

Standard Type

Male Square to Female Square

Part Number Standard	Part Number Tension	Male Sq. In.	Female Sq. In.	Type of Lock	Largest Diameter In.	Largest Diameter mm
KAM-37-3	KDM-37-3	3/8	3/8	Pin	3/4	19
-	KDM-37-6	3/8	3/8	Pin	3/4	19
-	KDM-37-B-3	3/8	3/8	Ball	3/4	19
KAM-38-6	KDM-38-6	3/8	3/8	Pin	7/8	22

Standard lengths are 3", 6", 9" and 12" (76, 152, 229 and 305mm)

1/2" Square Drive Sockets, SAE

6 Point and Double Hex, Standard Length

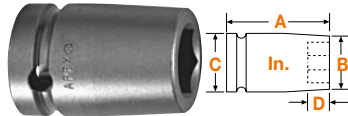

Part Number 6 Point	Part Number Double Hex	Hex Opening In.	Overall Length (A)	Diameter Nose End (B)	Diameter Drive End (C)	Opening Depth (D)
5108	-	1/4	1 1/2	7/16	15/16	5/32
5110	5110-D	5/16	1 1/2	1/2	15/16	3/16
5112	5112-D	3/8	1 1/2	5/8	15/16	1/4
5114	5114-D	7/16	1 1/2	11/16	15/16	9/32
5116	5116-D	1/2	1 1/2	13/16	15/16	11/32
SH-335	-	1/2	1 1/2	45/64	15/16	11/32
5118	5118-D	9/16	1 1/2	7/8	15/16	7/16
SH-336	SH-336-D	9/16	1 1/2	27/32	15/16	7/16
5119	-	19/32	1 1/2	15/16	15/16	7/16
5120	5120-D	5/8	1 1/2	1	1	7/16
SH-338	SH-338-D	5/8	1 1/2	15/16	1	7/16
5122	5122-D	11/16	1 1/2	1 1/8	1 1/8	7/16
SH-339	-	11/16	1 1/2	1 1/64	1 1/16	7/16
SW-282	SW-282-D	3/4	1 1/2	1 1/4	1 1/4	15/32
5124	5124-D	3/4	1 1/2	1 1/8	1 1/8	15/32
5126	5126-D	13/16	1 1/2	1 1/4	1 1/4	17/32
5128	5128-D	7/8	1 1/2	1 5/16	1 5/16	9/16
5130	5130-D	15/16	1 1/2	1 3/8	1 3/8	5/8
5131	-	31/32	1 1/2	1 1/2	1 1/2	5/8
5132	5132-D	1	1 1/2	1 1/2	1 1/2	5/8
5134	5134-D	1 1/16	1 5/8	1 1/2	1 1/2	11/16
5136	5136-D	1 1/8	1 5/8	1 5/8	1 5/8	3/4
5138	5138-D	1 3/16	1 5/8	1 3/4	1 3/4	3/4
5140	5140-D	1 1/4	1 3/4	1 3/4	1 3/4	13/16
5142	-	1 5/16	1 3/4	1 7/8	1 7/8	13/16
5144	5144-D	1 3/8	1 7/8	2	2	13/16
5146	-	1 7/16	2	2	2	15/16
5148	5148-D	1 1/2	2	2 1/8	2 1/8	1
5152	5152-D	1 5/8	2	2 3/8	2 3/8	1 1/8
5154	-	1 11/16	2	2 3/8	2 3/8	1 1/8
5156	-	1 3/4	2	2 1/2	2 1/2	1 1/8

6 Point and Double Hex, Thin Wall, Standard Length



Part Number 6 Point	Part Number Double Hex	Hex Opening In.	Overall Length (A)	Diameter Nose End (B)	Diameter Drive End (C)	Opening Depth (D)
5412	5412-D	3/8	1 1/2	19/32	15/16	1/4
5414	5414-D	7/16	1 1/2	21/32	15/16	9/32
5416	5416-D	1/2	1 1/2	23/32	15/16	11/32
5418	5418-D	9/16	1 1/2	13/16	15/16	7/16
5420	5420-D	5/8	1 1/2	7/8	15/16	7/16
5421	5421-D	21/32	1 1/2	29/32	15/16	7/16
5422*	5422-D*	11/16	1 1/2	15/16	15/16	7/16
OS-5424**	-	3/4	1 1/2	1 1/32	1 1/32	15/32
5424	5424-D	3/4	1 1/2	1 1/32	1 1/8	15/32
5426	5426-D	13/16	1 1/2	1 1/8	1 1/8	17/32
HE-1028	HE-1028-D	7/8	1 1/2	1 1/4	1 1/4	9/16
*5428	-	7/8	1 1/2	1 3/16	1 1/4	9/16
HE-530	-	15/16	1 1/2	1 5/16	1 5/16	5/8

* Extra thin wall
** No ring groove

Continued on next column.

6 Point and Double Hex, Thin Wall, Standard Length

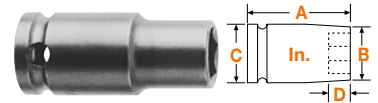

Continued from previous column.

Part Number 6 Point	Part Number Double Hex	Hex Opening In.	Overall Length (A)	Diameter Nose End (B)	Diameter Drive End (C)	Opening Depth (D)
5430*	5430-D*	15/16	1 1/2	1 1/4	1 1/4	5/8
5432	5432-D	1	1 1/2	1 3/8	1 3/8	5/8
5434	5434-D	1 1/16	1 5/8	1 7/16	1 7/16	11/16
5436	5436-D	1 1/8	1 5/8	1 1/2	1 1/2	3/4
5438	-	1 3/16	1 5/8	1 5/8	1 5/8	3/4
5440	5440-D	1 1/4	1 3/4	1 11/16	1 3/4	13/16
5442	-	1 5/16	1 3/4	1 25/32	1 7/8	13/16

* Extra thin wall
** No ring groove

6 Point and Double Hex, Long & Extra Long Length



Part Number 6 Point	Part Number Double Hex	Hex Opening In.	Overall Length (A)	Diameter Nose End (B)	Diameter Drive End (C)	Opening Depth (D)
5210	-	5/16	2 1/4	1/2	15/16	3/16
5310	-	5/16	3 1/4	1/2	15/16	3/16
5212	-	3/8	2 1/4	5/8	15/16	1/4
5312	-	3/8	3 1/4	5/8	15/16	1/4
5214	-	7/16	2 1/4	11/16	15/16	9/32
5314	-	7/16	3 1/4	11/16	15/16	9/32
5216	5216-D	1/2	2 1/4	13/16	15/16	11/32
5316	5316-D	1/2	3 1/4	13/16	15/16	11/32
5218	5218-D	9/16	2 1/4	7/8	15/16	7/16
5318	5318-D	9/16	3 1/4	7/8	15/16	7/16
5220	-	5/8	2 1/4	1	1	7/16
5320	-	5/8	3 1/4	1	1	7/16
5222	-	11/16	2 1/4	1 1/8	1 1/8	7/16
5322	5322-D	11/16	3 1/4	1 1/8	1 1/8	7/16
5224	5224-D	3/4	2 1/4	1 1/8	1 1/8	15/32
5324	5324-D	3/4	3 1/4	1 1/8	1 1/8	15/32
SW-493	-	3/4	2 1/4	1 1/4	1 1/4	15/32
5226	5226-D	13/16	2 1/4	1 1/4	1 1/4	17/32
5326	-	13/16	3 1/2	1 1/4	1 1/4	17/32
5228	5228-D	7/8	2 1/4	1 5/16	1 5/16	9/16
5328	-	7/8	3 1/2	1 5/16	1 5/16	9/16
5230	5230-D	15/16	2 1/4	1 3/8	1 3/8	5/8
5330	5330-D	15/16	3 1/2	1 3/8	1 3/8	5/8
5232	-	1	2 1/4	1 1/2	1 1/2	5/8
5332	-	1	3 1/2	1 1/2	1 1/2	5/8
5234	-	1 1/16	2 3/8	1 1/2	1 1/2	11/16
5334	-	1 1/16	3 1/2	1 1/2	1 1/2	11/16
5236	5236-D	1 1/8	2 3/8	1 5/8	1 5/8	3/4
5336	5336-D	1 1/8	3 1/2	1 5/8	1 5/8	3/4
5238	-	1 3/16	2 3/8	1 3/4	1 3/4	3/4
5338	-	1 3/16	3 1/2	1 3/4	1 3/4	3/4
5240	5240-D	1 1/4	2 1/2	1 3/4	1 3/4	13/16
5340	5340-D	1 1/4	3 1/2	1 3/4	1 3/4	13/16
5242	-	1 5/16	2 1/2	1 7/8	1 7/8	13/16
5342	-	1 5/16	3 1/2	1 7/8	1 7/8	13/16
5244	-	1 3/8	2 1/2	2	2	13/16
5344	-	1 3/8	3 5/8	2	2	13/16
5248	-	1 1/2	2 1/2	2 1/8	2 1/8	1
5348	-	1 1/2	3 3/4	2 1/8	2 1/8	1

1/2" Square Drive Sockets, SAE

6 Point and Double Hex, Thin Wall, Extra Long Length



Part Number 6 Point	Part Number Double Hex	Hex Opening In.	Overall Length (A)	Diameter Nose End (B)	Diameter Drive End (C)	Opening Depth (D)
5510	-	5/16	3 1/4	1/2	15/16	3/16
5512	5512-D	3/8	3 1/4	19/32	15/16	1/4
5514	5514-D	7/16	3 1/4	21/32	15/16	9/32
5516	5516-D	1/2	3 1/4	23/32	15/16	11/32
OS-5516*	-	1/2	3 1/4	47/64	7/8	11/32
5518	5518-D	9/16	3 1/4	13/16	15/16	7/16
OS-5518*	-	9/16	3 1/4	13/16	27/32	7/16
5520	5520-D	5/8	3 1/4	7/8	15/16	7/16
5522	5522-D	11/16	3 1/4	15/16	15/16	7/16
5524	5524-D	3/4	3 1/4	1 1/32	1 1/8	15/32
5526	5526-D	13/16	3 1/2	1 1/8	1 1/8	17/32
5528	5528-D	7/8	3 1/2	1 3/16	1 1/4	9/16
5530	5530-D	15/16	3 1/2	1 1/4	1 1/4	5/8
5532	5532-D	1	3 1/2	1 3/8	1 3/8	5/8
5534	5534-D	1 1/16	3 1/2	1 7/16	1 7/16	11/16

* No ring groove.

Magnetic, Standard Length

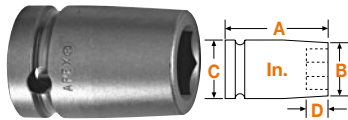

Part Number Fixed Magnet	Hex Opening mm	Overall Length (A)	Diameter Nose End (B)	Diameter Drive End (C)	Opening Depth (D)
M-5110	5/16	1 1/2	1/2	15/16	3/16
M-5112	3/8	1 1/2	5/8	15/16	1/4
M-5114	7/16	1 1/2	11/16	15/16	9/32
M-5116	1/2	1 1/2	13/16	15/16	11/32
MSH-335	1/2	1 1/2	45/64	15/16	11/32
M-5118	9/16	1 1/2	7/8	15/16	7/16
MSH-336	9/16	1 1/2	27/32	15/16	7/16
M-5120	5/8	1 1/2	1	1	7/16
M-5122	11/16	1 1/2	1 1/8	1 1/8	7/16
M-5124	3/4	1 1/2	1 1/8	1 1/8	15/32

Magnetic, Thin Wall, Standard Length

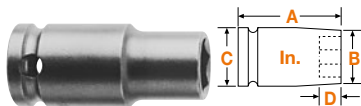

Part Number Fixed Magnet	Hex Opening mm	Overall Length (A)	Diameter Nose End (B)	Diameter Drive End (C)	Opening Depth (D)
M-5416	1/2	1 1/2	23/32	15/16	11/32
M-5418	9/16	1 1/2	13/16	15/16	7/16
M-5420	5/8	1 1/2	7/8	15/16	7/16

Magnetic, Long Length & Extra Long Length



Part Number Fixed Magnet	Part Number Bolt Clearance	Hex Opening In.	Overall Length (A)	Diameter Nose End (B)	Diameter Drive End (C)	Opening Depth (D)
-	MB-5212	3/8	2 1/4	5/8	15/16	1/4
M-5512*	-	3/8	3 1/4	19/32	15/16	1/4
-	MB-5214	7/16	2 1/4	11/16	15/16	9/32
M-5216	MB-5216	1/2	2 1/4	13/16	15/16	11/32
M-5316	-	1/2	3 1/4	13/16	15/16	11/32
M-5218	-	9/16	2 1/4	7/8	15/16	7/16
-	MB-HE9518	9/16	2 1/4	7/8	15/16	7/16
M-5518*	-	9/16	3 1/4	13/16	15/16	7/16
-	MB-5220	5/8	2 1/4	1	1	7/16

*Thin Wall

Surface Drive & Fast Lead, Standard Length

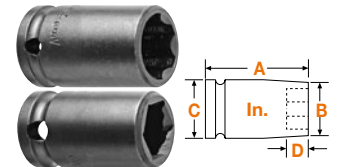

Part Number Fixed Magnet	Part Number Bolt Clearance	Hex Opening In.	Overall Length (A)	Diameter Nose End (B)	Diameter Drive End (C)	Opening Depth (D)
SF-5112	-	3/8	1 1/2	5/8	15/16	1/4
-	FL-5114	7/16	1 1/2	11/16	15/16	9/32
SF-5116	FL-5116	1/2	1 1/2	13/16	15/16	11/32
SF-SH-335	FL-SH-335	1/2	1 1/2	45/64	15/16	11/32
SF-5118	FL-5118	9/16	1 1/2	7/8	15/16	7/16
SF-SH-336	-	9/16	1 1/2	27/32	15/16	7/16
SF-5120	FL-5120	5/8	1 1/2	1	1	7/16
SF-5122	FL-5122	11/16	1 1/2	1 1/8	1 1/8	7/16
SF-5124	FL-5124	3/4	1 1/2	1 1/8	1 1/8	15/32
SF-SW-282	-	3/4	1 1/2	1 1/4	1 1/4	15/32
SF-5126	FL-5126	13/16	1 1/2	1 1/4	1 1/4	17/32
SF-5128	FL-5128	7/8	1 1/2	1 5/16	1 5/16	9/16
SF-5130	FL-5130	15/16	1 1/2	1 3/8	1 3/8	5/8
SF-5132	FL-5132	1	1 1/2	1 1/2	1 1/2	5/8
SF-5134	FL-5134	1 1/16	1 5/8	1 1/2	1 1/2	11/16

Surface Drive & Fast Lead, Thin Wall, Standard Length

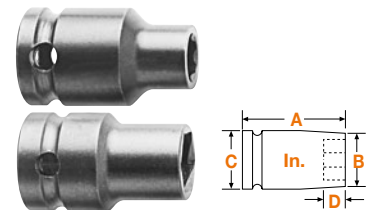

Part Number Fixed Magnet	Part Number Bolt Clearance	Hex Opening In.	Overall Length (A)	Diameter Nose End (B)	Diameter Drive End (C)	Opening Depth (D)
SF-5412	-	3/8	1 1/2	19/32	15/16	1/4
SF-5414	-	7/16	1 1/2	21/32	15/16	9/32
SF-5416	FL-5416	1/2	1 1/2	23/32	15/16	11/32
SF-5418	FL-5418	9/16	1 1/2	13/16	15/16	7/16
SF-5420	-	5/8	1 1/2	7/8	15/16	7/16
SF-5422	-	11/16	1 1/2	15/16	15/16	7/16
SF-5424	-	3/4	1 1/2	1 1/32	1 1/8	15/32
SF-5426	-	13/16	1 1/2	1 1/8	1 1/8	17/32

1/2" Square Drive Sockets, SAE

Surface Drive & Fast Lead, Long and Extra Long Length

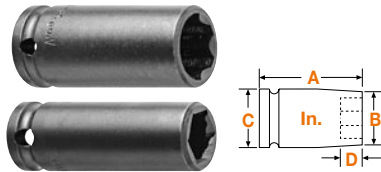

Part Number Surface Drive	Part Number Fast-Lead	Hex Opening In.	Overall Length (A)	Diameter Nose End (B)	Diameter Drive End (C)	Opening Depth (D)
SF-5212	-	3/8	2 1/4	9/16	15/16	9/32
SF-5216	FL-5216	1/2	2 1/4	13/16	15/16	11/32
-	FL-5316	1/2	3 1/4	13/16	15/16	11/32
SF-HE-9518	FL- HE-9518	9/16	2 1/4	7/8	7/8	7/16
SF-5218	FL-5218	9/16	2 1/4	7/8	15/16	7/16
SF-5318	FL-5318	9/16	3 1/4	7/8	15/16	7/16
SF-5320	FL-5320	5/8	3 1/4	1	1	7/16
SF-5222	FL-5222	11/16	2 1/4	1 1/8	1 1/8	7/16
SF-5224	FL-5224	3/4	2 1/4	1 1/8	1 1/8	15/32
-	FL-SW-493	3/4	2 1/4	1 1/4	1 1/4	15/32
SF-5324	FL-5324	3/4	3 1/4	1 1/8	1 1/8	15/32
SF-5226	FL-5226	13/16	2 1/4	1 1/4	1 1/4	17/32
-	FL-5326	13/16	3 1/2	1 1/4	1 1/4	17/32
SF-5228	FL-5228	7/8	2 1/4	1 5/16	1 5/16	9/16
SF-5328	-	7/8	3 1/2	1 5/16	1 5/16	9/16
SF-5230	-	15/16	2 1/4	1 3/8	1 3/8	5/8
SF-5330	-	15/16	3 1/2	1 3/8	1 3/8	5/8
SF-5232	-	1	2 1/4	1 1/2	1 1/2	5/8

Surface Drive, Thin Wall, Extra Long Length



Part Number, Surface-Drive	Hex Opening In.	Overall Length (A)	Diameter Nose End (B)	Diameter Drive End (C)	Opening Depth (D)
SF-5514	7/16	3 1/4	21/32	15/16	9/32
SF-5516	1/2	3 1/4	23/32	15/16	11/32
SF-5518	9/16	3 1/4	13/16	15/16	7/16
SF-5520	5/8	3 1/4	7/8	15/16	7/16
SF-5524	3/4	3 1/4	1 1/32	1 1/8	15/32
SF-5526	13/16	3 1/4	1 1/8	1 1/8	17/32
SF-5528	7/8	3 1/2	1 3/16	1 1/4	9/16
SF-5532	1	3 1/2	1 3/8	1 3/8	5/8

1/2" Square Drive Sockets For SAE Sheet Metal Screws

6 Point & 6 Point Magnetic, for Predrilled Holes*

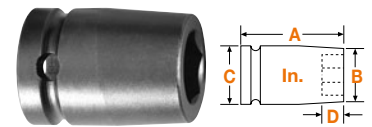

Part Number 6 Point	Part Number Magnetic	Hex Opening mm	Overall Length (A)	Diameter Nose End (B)	Diameter Drive End (C)	Opening Depth (D)
5E10	M5E10	5/16	1 1/2	1/2	15/16	3/16
5E12	M5E12	3/8	1 1/2	5/8	15/16	1/4
-	M5E14	7/16	1 1/2	11/16	15/16	9/32
5E16	M5E16	1/2	1 1/2	13/16	15/16	11/32
-	M5E18	9/16	1 1/2	15/16	15/16	7/16

6 Point & 6 Point Magnetic, for Self-Tapping Screws*

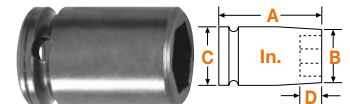

Part Number 6 Point	Part Number Magnetic	Hex Opening In.	Overall Length (A)	Diameter Nose End (B)	Diameter Drive End (C)	Opening Depth (D)
-	M5P10	5/16	1 1/2	1/2	15/16	3/16
5P12	M5P12	3/8	1 1/2	5/8	15/16	1/4
5P14	M5P14	7/16	1 1/2	11/16	15/16	9/32
-	M5P16	1/2	1 1/2	13/16	15/16	11/32
-	M5P18	9/16	1 1/2	15/16	15/16	7/16

*Sockets for predrilled holes are intermediate hardness; sockets for self-tapping screws are maximum hardness.

If the tool you need does not appear in this catalog, give us a call. The odds are, we may have what you need as a non-catalog item. If not, our experienced staff of tooling experts can design and manufacture "specials" to meet the needs of your specific application.

Give us a call at +49 7363-81-129 or visit our website www.apexpowertools.eu

1/2" Square Drive Sockets For SAE Square Nuts

Single Square & Double Square, Standard Length



Part No. Single Square	Part No. Double Square	Hex Opening In.	Overall Length (A)	Diameter Nose End (B)	Diameter Drive End (C)	Opening Depth (D)
5609	-	9/32	1 1/2	1/2	15/16	3/16
5610	5610-D	5/16	1 1/2	5/8	15/16	1/4
5612	5612-D	3/8	1 1/2	3/4	15/16	1/4
5614	5614-D	7/16	1 1/2	7/8	15/16	9/32
5616	5616-D	1/2	1 1/2	1	1	11/32
5618	5618-D	9/16	1 1/2	1 1/8	1 1/8	7/16
5620	5620-D	5/8	1 1/2	1 1/4	1 1/4	7/16
5622	-	11/16	1 1/2	1 1/4	1 1/4	7/16
5624	5624-D	3/4	1 1/2	1 3/8	1 3/8	15/32
5626	-	13/16	1 1/2	1 1/2	1 1/2	17/32
5628	-	7/8	1 1/2	1 5/8	1 5/8	5/8
5632	-	1	1 5/8	1 3/4	1 3/4	5/8
5634	-	1 1/16	1 3/4	1 7/8	1 7/8	11/16
5636	5636-D	1 1/8	1 3/4	2	2	3/4

Single Square & Double Square, Thin Wall, Standard Length



Part No. Single Square	Part No. Double Square	Hex Opening In.	Overall Length (A)	Diameter Nose End (B)	Diameter Drive End (C)	Opening Depth (D)
5912	5912-D	3/8	1 1/2	11/16	15/16	1/4
5914	5914-D	7/16	1 1/2	25/32	15/16	9/32
5918	5918-D	9/16	1 1/2	1	1	7/16
5920	-	5/8	1 1/2	1 3/32	1 1/8	7/16

Single Square & Double Square, Long & Extra Long Length



Part No. Single Square	Part No. Double Square	Hex Opening In.	Overall Length (A)	Diameter Nose End (B)	Diameter Drive End (C)	Opening Depth (D)
5812	-	3/8	3 1/4	3/4	15/16	1/4
5716	-	1/2	2 1/4	1	1	11/32
-	5816-D	1/2	3 1/4	1	1	7/16
5720	-	5/8	2 1/4	1 1/4	1 1/4	7/16
5820	5820-D	5/8	3 1/2	1 1/4	1 1/4	7/16
5822	5822-D	11/16	3 1/2	1 1/4	1 1/4	7/16
5724	5724-D	3/4	2 1/4	1 3/8	1 3/8	15/32
-	5826-D	13/16	3 1/2	1 1/2	1 1/2	17/32
5728	-	7/8	2 1/4	1 5/8	1 5/8	5/8
-	5832-D	1	3 1/2	1 3/4	1 3/4	5/8
-	5834-D	1 1/16	3 1/2	1 7/8	1 7/8	11/16
-	5836-D	1 1/8	3 1/2	2	2	3/4

1/2" Square Drive Socket Sets, SAE



6 Point

APS58XL 8 pieces, extra long length:
1/2, 9/16, 5/8, 11/16, 3/4, 13/16, 7/8, 15/16

1/2" Square Drive Universal Wrenches, SAE

6 Point & Double Hex

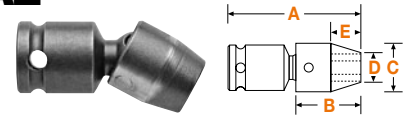

Part Number 6 Point	Part Number 12 Point	Hex Opening In.	Overall Length (A)	Socket Length (B) In.	Socket Diameter (C) In.	Nose End Diameter (D) In.	Clearance Depth (E) In.
SA-120	SA-120-D	5/16	1 53/64	3/4	3/4	7/16	5/16
SA-216	SA-216-D	3/8	2 11/64	7/8	7/8	9/16	11/32
SA-217	SA-217-D	7/16	2 15/64	15/16	7/8	5/8	13/32
SA-316	-	7/16	2 17/64	15/16	1	5/8	3/8
SA-218	SA-218-D	1/2	2 19/64	1	7/8	11/16	15/32
SA-317	-	1/2	2 31/64	1	1	11/16	7/16
SA-219	SA-219-D	9/16	2 23/64	1 1/16	7/8	3/4	17/32
SA-318	SA-318-D	9/16	2 29/64	1 1/8	1	3/4	9/16
SA-221	SA-221-D	5/8	2 27/64	1 1/8	7/8	7/8	19/32
SA-320	-	5/8	2 33/64	1 3/16	1	27/32	5/8
SA-402	SA-402-D	5/8	2 49/64	1 1/4	1 1/4	7/8	33/64
SA-321	SA-321-D	11/16	2 37/64	1 1/4	1	1	11/16
SA-322	SA-322-D	3/4	2 37/64	1 1/4	1 1/8	1 1/8	11/16
SA-404	SA-404-D	3/4	2 57/64	1 3/8	1 1/4	1 1/32	5/8
SA-501	-	3/4	3 1/32	1 5/8	1 1/2	1 1/8	25/32
SA-406	-	13/16	2 57/64	1 3/8	1 1/4	1 1/8	41/64
SA-407	-	7/8	2 57/64	1 3/8	1 3/16	1 5/16	41/64
SA-409	SA-409-D	15/16	2 57/64	1 3/8	1 5/16	1 5/16	41/64
SA-505	-	15/16	3 5/32	1 3/4	1 1/2	1 3/8	29/32
SA-410	-	1	2 61/64	1 7/16	1 1/2	1 1/2	45/64
SA-411	-	1 1/16	3 1/64	1 1/2	1 1/2	1 1/2	49/64
SA-508	-	1 1/8	3 9/32	1 7/8	1 5/8	1 5/8	1 1/32
SA-510	-	1 1/4	3 13/32	2	1 3/4	1 3/4	1 5/32

Universal wrenches must not be used with impact drivers. Maximum operating angle is 30°.

1/2" Square Drive IronBand™ Univ. Wrenches, SAE

6 Point

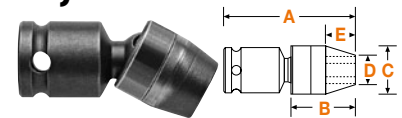

Part Number 6 Point	Hex Opening In.	Overall Length (A)	Socket Length (B) In.	Socket Diameter (C) In.	Nose End Diameter (D) In.	Clearance Depth (E) In.
SA-C-216	3/8	2,17	,88	,88	,56	,34
SA-C-217	7/16	2,23	,94	,88	,63	,41
SA-C-218	1/2	2,30	1,00	,88	,69	,47
SA-C-219	9/16	2,36	1,06	,88	,75	,53
SA-C-221	5/8	2,42	1,13	,88	,88	,59
SA-C-321	11/16	2,58	1,25	1,00	1,00	,69
SA-C-322	3/4	2,58	1,25	1,13	1,13	,69
SA-C-407	7/8	2,89	1,38	1,19	1,31	,64
SA-C-409	15/16	2,89	1,38	1,31	1,31	,64
SA-C-410	1	2,95	1,44	1,50	1,50	,70
SA-C-411	1 1/16	3,02	1,50	1,50	1,50	,77
SA-C-508	1 1/8	3,28	1,88	1,63	1,63	1,03
SA-C-510	1 1/4	3,41	2,00	1,75	1,75	1,16

Universal wrenches must not be used with impact drivers. Maximum operating angle is 30°.

1/2" Square Drive Universal Wrench Set, SAE

6 Point



APU56 6 pieces, standard length:
7/16, 1/2, 9/16, 5/8, 11/16, 3/4

Universal Wrenches 1/2" Square Drive, SAE - Extension

6 Point, Standard and Tension Type



Tension Type



Standard Type

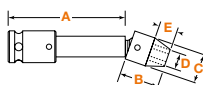

Part Number Standard	Part Number Tensio	Hex Opening In.	Shank Length (A) In.	Socket Length (B) In.	Socket Diameter (C) In.	Nose End Diameter (D) In.	Opening Depth (E) In.
KH-43-6	KN-43-6	3/8	6	13/16	5/8	17/32	7/16
-	KN-43-9	3/8	9	13/16	5/8	17/32	7/16
KH-44-6	KN-44-6	7/16	6	7/8	5/8	5/8	1/2
KH-45-3	-	1/2	3	7/8	11/16	11/16	1/2
KH-45-4	-	1/2	4	7/8	11/16	11/16	1/2
KH-45-6	KN-45-6	1/2	6	7/8	11/16	11/16	1/2
-	KN-45-9	1/2	9	7/8	11/16	11/16	1/2
KH-104-6	KN-104-6	1/2	6	1	3/4	3/4	9/16
-	KN-104-9	1/2	9	1	3/4	3/4	9/16
KH-202-6	KN-202-6	1/2	6	1	7/8	11/16	15/32
-	KN-202-8	1/2	9	1	7/8	11/16	15/32
KH-105-3	-	9/16	3	1	13/16	13/16	9/16
KH-105-6	KN-105-6	9/16	6	1	13/16	13/16	9/16
-	KN-105-9	9/16	9	1	13/16	13/16	9/16
KH-105-12	KN-105-12	9/16	12	1	13/16	13/16	9/16
KH-203-4	-	9/16	4	1 1/16	7/8	3/4	17/32
KH-203-6	KN-203-6	9/16	6	1 1/16	7/8	3/4	17/32
KH-203-9	KN-203-9	9/16	9	1 1/16	7/8	3/4	17/32
-	KN-203-12	9/16	12	1 1/16	7/8	3/4	17/32
-	KN-318-3	9/16	3	1 1/8	1	3/4	9/16
KH-318-4	KN-318-4	9/16	4	1 1/8	1	3/4	9/16
KH-205-3	-	5/8	3	1 1/8	7/8	7/8	19/32
KH-205-4	-	5/8	4	1 1/8	7/8	7/8	19/32
KH-205-6	KN-205-6	5/8	6	1 1/8	7/8	7/8	19/32
-	KN-205-9	5/8	9	1 1/8	7/8	7/8	19/32
KH-205-12	KN-205-12	5/8	12	1 1/8	7/8	7/8	19/32
KH-320-6	-	5/8	6	1 3/16	1	27/32	5/8
-	KN-320-12	5/8	12	1 3/16	1	27/32	5/8
KH-321-6	-	11/16	6	1 1/4	1	1	11/16
KH-322-6	KN-322-6	3/4	6	1 1/4	1 1/8	1 1/8	11/16
-	KN-322-9	3/4	9	1 1/4	1 1/8	1 1/8	11/16
-	KN-322-12	3/4	12	1 1/4	1 1/8	1 1/8	11/16
-	KN-404-6	3/4	6	1 3/8	1 1/4	1 1/32	41/64
KH-409-3	-	15/16	3	1 3/8	1 5/16	1 5/16	41/64
KH-409-4	-	15/16	4	1 3/8	1 5/16	1 5/16	41/64
KH-409-6	-	15/16	6	1 3/8	1 5/16	1 5/16	41/64
KH-409-12	-	15/16	12	1 3/8	1 5/16	1 5/16	41/64

Universal wrenches must not be used with impact drivers. Maximum operating angle is 30°. Actual design of universal wrenches may not be exactly like pictures above.

1/2" Square Drive IronBand™ Universal Wrenches, SAE - Extension

6 Point

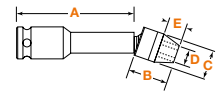

Part Number Standard	Part Number Tensio	Hex Opening In.	Shank Length (A) In.	Socket Length (B) In.	Socket Diameter (C) In.	Nose End Diameter (D) In.	Opening Depth (E) In.
KHW-C-43-6	KNW-C-43-6	3/8	6	,81	,63	,53	,44
KHW-C-44-6	KNW-C-44-6	7/16	6	,88	,63	,63	,50
KHW-C-45-6	KNW-C-45-6	1/2	6	,88	,69	,69	,50
KHW-C-105-6	KNW-C-105-6	9/16	6	1,00	,81	,81	,56
KNW-C-105-12		9/16	12	1,00	,81	,81	,56
KHW-C-205-6	KNW-C-205-6	5/8	6	1,13	,88	,88	,59
KHW-C-205-12	KNW-C-205-12	5/8	12	1,13	,88	,88	,59
KHW-C-322-6	KNW-C-322-6	3/4	6	1,25	1,13	1,13	,69
	KNW-C-322-12	3/4	12	1,25	1,13	1,13	,69
KHW-C-409-6		15/16	6	1,38	1,31	1,31	,64

Universal wrenches must not be used with impact drivers. Maximum operating angle is 30°.

1/2" Square Drive Socket Head Bits, SAE

Complete, Adapter Only, Insert Only

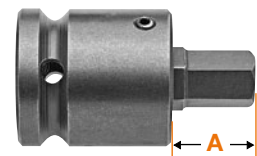

Complete	Part Number		Hex Size	Overall Length		Length of Insert (A)	
	Adapter Only	Insert Only		In.	mm	In.	mm
SZ-22	SC-514	SZ-14-A	1/4	2 1/2	64	1 3/8	35
SZ-23	SC-514	SZ-15-A	5/16	2 1/2	64	1 3/8	35
SZ-24	SC-514	SZ-16-A	3/8	2 1/2	64	1 3/8	35
SZ-25	SC-514	SZ-17-A	1/2	2 1/2	64	1 3/8	35
SZ-42	SC-520	SZ-31-A	1/2	2 1/2	64	1 9/16	35
SZ-43	SC-514	SZ-18-A	9/16	2 1/2	64	1 3/8	35
SZ-44	SC-529	SZ-32-A	9/16	2 1/2	64	1 9/16	35
SZ-26	SC-514	SZ-19-A	5/8	2 1/2	64	1 3/8	35

For a complete listing, see page 19. Adapters with an "SC" prefix feature a set screw for locking in the bit. An "RP" prefix indicates adapters with a roll pin that is inserted through the bit.

1/2" Square Drive Sockets, Metric

6 Point & Double Hex, Standard Length

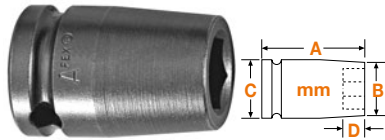

Part Number 6 Point	Part Number 12 Point	Hex Opening mm.	Overall Length (A)	Diameter Nose End (B)	Diameter Drive End (C)	Opening Depth (D)
10MM15	10MM15-D	10	38,1	16,7	23,8	6,4
11MM15	11MM15-D	11	38,1	17,5	23,8	7,2
12MM15	12MM15-D	12	38,1	19,1	23,8	7,2
13MM15	13MM15-D	13	38,1	22,2	23,8	8,7
14MM15	14MM15-D	14	38,1	22,2	23,8	11,1
15MM15	15MM15-D	15	38,1	23,8	23,8	11,1
16MM15	16MM15-D	16	38,1	25,4	25,4	11,1
17MM15	17MM15-D	17	38,1	28,6	28,6	11,1
18MM15	18MM15-D	18	38,1	28,6	28,6	11,1
19MM15	19MM15-D	19	38,1	28,6	28,6	11,9
20MM15	-	20	38,1	31,7	31,7	11,9
21MM15	21MM15-D	21	38,1	31,7	31,7	13,5
22MM15	22MM15-D	22	38,1	33,3	33,3	14,3
23MM15	23MM15-D	23	38,1	34,9	34,9	15,9
24MM15	24MM15-D	24	38,1	34,9	34,9	15,9
25MM15	-	25	38,1	38,1	38,1	15,9
26MM15	26MM15-D	26	38,1	38,1	38,1	15,9
27MM15	27MM15-D	27	41,3	41,3	41,3	17,5
28MM15	-	28	41,3	41,3	41,3	19,1
29MM15	29MM15-D	29	41,3	44,4	44,4	19,1
30MM15	30MM15-D	30	41,3	44,4	44,4	19,1
32MM15	32MM15-D	32	44,4	44,4	44,4	20,6
33MM15	-	33	44,4	47,6	47,6	20,6
34MM15	-	34	47,6	47,5	47,5	20,5
35MM15	-	35	47,6	50,8	50,8	20,6
36MM15	-	36	47,6	50,8	50,8	23,8

6 Point & Double Hex, Long Length



Part Number 6 Point	Part Number 12 Point	Hex Opening mm.	Overall Length (A)	Diameter Nose End (B)	Diameter Drive End (C)	Opening Depth (D)
10MM25	10MM25-D	10	57,1	16,7	23,8	6,4
11MM25	-	11	57,1	17,5	23,8	7,2
12MM25	12MM25-D	12	57,1	19,1	23,8	7,2
13MM25	13MM25-D	13	57,1	22,2	23,8	8,7
14MM25	-	14	57,1	22,2	23,8	11,1
15MM25	15MM25-D	15	57,1	23,8	23,8	11,1
16MM25	16MM25-D	16	57,1	25,4	25,4	11,1
17MM25	17MM25-D	17	57,1	28,6	28,6	11,1
18MM25	18MM25-D	18	57,1	28,6	28,6	11,1
19MM25	-	19	57,1	28,6	28,6	11,9
20MM25	20MM25-D	20	57,1	31,7	31,7	11,9
21MM25	21MM25-D	21	57,1	31,7	31,7	13,5
22MM25	22MM25-D	22	57,1	33,3	33,3	14,3
23MM25	23MM25-D	23	57,1	34,9	34,9	15,9
24MM25	24MM25-D	24	57,1	34,9	34,9	15,9
25MM25	-	25	57,1	38,1	38,1	15,9
26MM25	-	26	57,1	38,1	38,1	15,9
27MM25	-	27	60,3	41,3	41,3	17,5
28MM25	-	28	60,3	41,3	41,3	19,1
30MM25	30MM25-D	30	60,3	44,4	44,4	19,1
32MM25	-	32	63,5	44,4	44,4	20,6

6 Point & Double Hex, Thin Wall, Standard Length

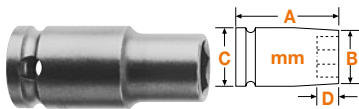

Part Number 6 Point	Part Number 12 Point	Hex Opening mm.	Overall Length (A)	Diameter Nose End (B)	Diameter Drive End (C)	Opening Depth (D)
10MM45	10MM45-D	10	38,1	15,9	23,8	6,4
12MM45	12MM45-D	12	38,1	17,5	23,8	7,2
13MM45	13MM45-D	13	38,1	18,7	23,8	8,7
14MM45	14MM45-D	14	38,1	20,6	23,8	11,1
15MM45	15MM45-D	15	38,1	22,2	23,8	11,1
16MM45	16MM45-D	16	38,1	22,2	23,8	11,1
17MM45	17MM45-D	17	38,1	23,8	23,8	11,1
18MM45	18MM45-D	18	38,1	25,4	25,4	11,1
19MM45	-	19	38,1	26,3	26,3	11,9
21MM45	21MM45-D	21	38,1	28,6	28,6	13,5
22MM45	22MM45-D	22	38,1	30,2	31,7	14,3

6 Point & Double Hex, Extra Long Length



Part Number 6 Point	Part Number 12 Point	Hex Opening mm.	Overall Length (A)	Diameter Nose End (B)	Diameter Drive End (C)	Opening Depth (D)
10MM35	10MM35-D	10	82,5	16,7	23,8	6,4
11MM35	-	11	82,5	17,5	23,8	7,2
12MM35	12MM35-D	12	82,5	19,1	23,8	7,2
13MM35	13MM35-D	13	82,5	22,2	23,8	8,7
14MM35	14MM35-D	14	82,5	22,2	23,8	11,1
15MM35	-	15	82,5	23,8	23,8	11,1
16MM35	16MM35-D	16	82,5	25,4	25,4	11,1
17MM35	17MM35-D	17	82,5	28,6	28,6	11,1
18MM35	18MM35-D	18	82,5	28,6	28,6	11,1
19MM35	19MM35-D	19	82,5	28,6	28,6	11,9
20MM35	20MM35-D	20	88,9	31,7	31,7	11,9
21MM35	21MM35-D	21	88,9	31,7	31,7	13,5
22MM35	22MM35-D	22	88,9	33,3	33,3	14,3
24MM35	24MM35-D	24	88,9	34,9	34,9	15,9
25MM35	-	25	88,9	38,1	38,1	15,9

1/2" Square Drive Sockets, Metric

6 Point & Double Hex, Thin Wall, Extra Long Length



Part Number 6 Point	Part Number 12 Point	Hex Opening mm.	Overall Length (A)	Diameter Nose End (B)	Diameter Drive End (C)	Opening Depth (D)
10MM55	10MM55-D	10	82,5	15,9	23,8	6,4
11MM55	-	11	82,5	16,7	23,8	7,2
12MM55	12MM55-D	12	82,5	17,5	23,8	7,2
13MM55	13MM55-D	13	82,5	18,7	23,8	8,7
14MM55	14MM55-D	14	82,5	20,6	23,8	11,1
15MM55	15MM55-D	15	82,5	22,2	23,8	11,1
16MM55	16MM55-D	16	82,5	22,2	23,8	11,1
17MM55	17MM55-D	17	82,5	23,8	23,8	11,1
18MM55	18MM55-D	18	82,5	25,4	25,4	11,1
19MM55	-	19	82,5	26,3	26,3	11,9
21MM55	21MM55-D	21	88,9	28,6	28,6	13,5
22MM55	22MM55-D	22	88,9	30,2	31,7	14,3
24MM55	24MM55-D	24	88,9	33,3	33,3	15,9
26MM55	-	26	88,9	34,9	34,9	15,9
27MM55	27MM55-D	27	88,9	36,5	38,1	17,5
29MM55	-	29	88,9	38,1	38,1	19,1
30MM55	-	30	88,9	39,7	41,1	19,1
32MM55	-	32	88,9	42,9	42,9	20,6

Magnetic, Thin Wall, Standard Length

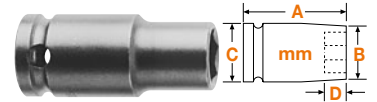

Part Number Fixed Magnet	Hex Opening mm	Overall Length (A)	Diameter Nose End (B)	Diameter Drive End (C)	Opening Depth (D)
M-13MM45	13	38,1	18,7	23,8	8,7
M-14MM45	14	38,1	20,6	23,8	11,1
M-15MM45	15	38,1	22,2	23,8	11,1

Magnetic, Long Length



Part Number Fixed Magnet	Part Number Magnetic Bolt Clearance	Hex Opening mm	Overall Length (A)	Diameter Nose End (B)	Diameter Drive End (C)	Opening Depth (D)
-	MB-10MM25	10	57,1	16,7	23,8	6,4
-	MB-12MM25	12	57,1	19,1	23,8	7,2
M-13MM25	MB-13MM25	13	57,1	22,2	23,8	8,7
-	MB-14MM25	14	57,1	22,2	23,8	11,1
M-15MM25	MB-15MM25	15	57,1	23,8	23,8	11,1
-	MB-16MM25	16	57,1	25,4	25,4	11,1
M-18MM25	MB-18MM25	18	57,1	28,6	28,5	11,1

Magnetic, Standard Length

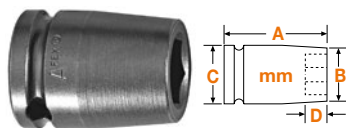

Part Number Fixed Magnet	Hex Opening mm	Overall Length (A)	Diameter Nose End (B)	Diameter Drive End (C)	Opening Depth (D)
M-10MM15	10	38,1	16,7	23,8	6,4
M-11MM15	11	38,1	17,5	23,8	7,2
M-12MM15	12	38,1	19,1	23,8	7,2
M-13MM15	13	38,1	22,2	23,8	8,7
M-14MM15	14	38,1	22,2	23,8	11,1
M-15MM15	15	38,1	23,8	23,8	11,1
M-16MM15	16	38,1	25,4	25,4	11,1
M-17MM15	17	38,1	28,6	28,6	11,1
M-18MM15	18	38,1	28,5	28,5	11,1
M-19MM15	19	38,1	28,6	28,6	11,9
M-21MM15	21	38,1	31,7	31,7	13,5

Magnetic, Extra Long Length



Part Number Fixed Magnet	Part Number Magnetic Bolt Clearance	Hex Opening mm	Overall Length (A)	Diameter Nose End (B)	Diameter Drive End (C)	Opening Depth (D)
M-13MM35	-	13	82,5	22,2	23,8	8,7
M-13MM55*	-	13	82,5	18,7	23,8	8,7
M-15MM35	MB-15MM35	15	82,5	23,8	23,8	11,1
M-18MM35	MB-18MM35	18	82,5	28,6	28,6	11,1
M-18MM55*	-	18	82,5	25,4	25,4	11,1

*Thin Wall

1/2" Square Drive Sockets, Metric

Surface Drive, Standard Length



Part Number Surface Drive	Hex Opening mm	Overall Length (A)	Diameter Nose End (B)	Diameter Drive End (C)	Opening Depth (D)
SF-10MM15	10	38,1	16,7	23,8	6,4
SF-11MM15	11	38,1	17,5	23,8	7,2
SF-12MM15	12	38,1	19,1	23,8	7,2
SF-13MM15	13	38,1	22,2	23,8	8,7
SF-14MM15	14	38,1	22,2	23,8	11,1
SF-15MM15	15	38,1	23,8	23,8	11,1
SF-16MM15	16	38,1	25,4	25,4	11,1
SF-17MM15	17	38,1	28,6	28,6	11,1
SF-18MM15	18	38,1	28,6	28,6	11,1
SF-19MM15	19	38,1	28,6	28,6	11,9
SF-20MM15	20	38,1	31,7	31,7	11,9
SF-21MM15	21	38,1	31,7	31,7	13,5
SF-22MM15	22	38,1	33,3	33,3	14,3
SF-23MM15	23	38,1	34,9	34,9	15,9
SF-24MM15	24	38,1	34,9	34,9	15,9

Surface Drive, Thin Wall, Standard Length

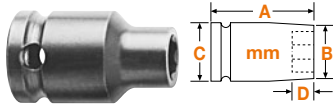

Part Number Surface Drive	Hex Opening mm	Overall Length (A)	Diameter Nose End (B)	Diameter Drive End (C)	Opening Depth (D)
SF-10MM45	10	38,1	15,9	23,8	6,4
SF-11MM45	11	38,1	16,7	23,8	7,2
SF-12MM45	12	38,1	17,5	23,8	7,2
SF-13MM45	13	38,1	18,7	23,8	8,7
SF-14MM45	14	38,1	20,6	23,8	11,1
SF-15MM45	15	38,1	22,2	23,8	11,1
SF-16MM45	16	38,1	22,2	23,8	11,1
SF-17MM45	17	38,1	23,8	23,8	11,1
SF-18MM45	18	38,1	25,4	25,4	11,1
SF-19MM45	19	38,1	26,3	26,3	11,9
SF-21MM45	21	38,1	28,6	28,6	11,9

Surface Drive, Long Length



Part Number Surface Drive	Hex Opening mm	Overall Length (A)	Diameter Nose End (B)	Diameter Drive End (C)	Opening Depth (D)
SF-10MM25	10	57,1	16,7	23,8	6,4
SF-11MM25	11	57,1	17,5	23,8	7,2
SF-12MM25	12	57,1	19,1	23,8	7,2
SF-13MM25	13	57,1	22,2	23,8	7,2
SF-14MM25	14	57,1	22,2	23,8	11,1
SF-15MM25	15	57,1	23,8	23,8	11,1
SF-16MM25	16	57,1	25,4	25,4	11,1
SF-17MM25	17	57,1	28,6	28,6	11,1
SF-18MM25	18	57,1	28,6	28,6	11,1
SF-19MM25	19	57,1	28,6	28,6	11,9
SF-21MM25	21	57,1	31,7	31,7	13,5
SF-22MM25	22	57,1	33,3	33,3	14,3
SF-24MM25	24	57,1	34,9	34,9	15,9

Surface Drive, Extra Long Length



Part Number Surface Drive	Hex Opening mm	Overall Length (A)	Diameter Nose End (B)	Diameter Drive End (C)	Opening Depth (D)
SF-10MM35	10	82,5	16,7	23,8	6,4
SF-12MM35	12	82,5	17,5	23,8	7,2
SF-13MM35	13	82,5	19,1	23,8	7,2
SF-14MM35	14	82,5	22,2	23,8	11,1
SF-15MM35	15	82,5	23,8	23,8	11,1
SF-16MM35	16	82,5	25,4	25,4	11,1
SF-17MM35	17	82,5	28,6	28,6	11,1
SF-18MM35	18	82,5	28,6	28,6	11,1
SF-19MM35	19	82,5	28,6	28,6	11,9
SF-21MM35	21	88,9	31,7	31,7	13,5
SF-22MM35	22	88,9	33,3	33,3	14,3
SF-24MM35	24	88,9	34,9	34,9	15,9

Surface Drive, Thin Wall, Extra Long Length



Part Number Surface Drive	Hex Opening mm	Overall Length (A)	Diameter Nose End (B)	Diameter Drive End (C)	Opening Depth (D)
SF-10MM55	10	82,5	15,9	23,8	6,4
SF-11MM55	11	82,5	16,7	23,8	7,2
SF-13MM55	13	82,5	18,7	23,8	8,7
SF-14MM55	14	82,5	20,6	23,8	11,1
SF-15MM55	15	82,5	22,2	23,8	11,1
SF-16MM55	16	82,5	22,2	23,8	11,1
SF-17MM55	17	82,5	23,8	23,8	11,1
SF-18MM55	18	82,5	25,4	25,4	11,1
SF-19MM55	19	82,5	26,3	26,3	11,9
SF-21MM55	21	88,9	28,6	28,6	13,5
SF-22MM55	22	88,9	30,2	31,7	15,9

1/2" Square Drive Sockets For Metric Sheet Metal Screws

6 Point & 6 Point Magnetic, For Regular Screws

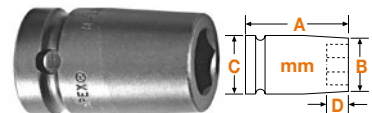

Part Number 6 Point	Part Number Magnetic	Hex Opening mm	Overall Length (A)	Diameter Nose End (B)	Diameter Drive End (C)	Opening Depth (D)
-	M-13MME5	13	38,1	22,2	23,8	8,7
15MME5	M-15MME5	15	38,1	23,8	23,8	11,1

1/2" Square Drive Socket Sets, Metric

6 Point



APS511M 11 pieces, standard length:
10mm, 11mm, 12mm, 13mm, 14mm, 15mm, 16mm, 17mm,
18mm, 19mm, 21mm

1/2" Square Drive Universal Wrenches, Metric

6 Point

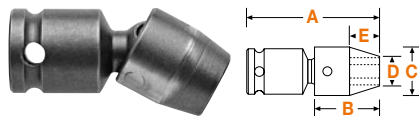

Part Number 6 Point	Hex Opening mm	Overall Length (A)	Socket Length (B)	Socket Diameter (C)	Nose End Diameter (D)	Opening Depth (E)
SA-57-13M	13	58	25,4	22,2	17,5	11,9
SA-57-14M	14	60	27,0	22,2	19,1	13,5
SA-58-15M	15	62	28,6	25,4	19,8	14,3
SA-58-16M	16	64	30,2	25,4	21,4	15,9
SA-58-17M	17	66	31,8	25,4	25,4	17,5
SA-58-18M	18	66	31,8	25,4	25,4	17,5
SA-510-19M	19	73	34,9	31,8	26,2	16,3
SA-510-20M	20	73	34,9	31,8	27,0	16,3
SA-510-21M	21	73	34,9	31,8	28,6	16,3
SA-510-22M	22	73	34,9	31,8	31,8	16,3
SA-510-24M	24	73	34,9	31,8	34,9	16,3

1/2" Square Drive IronBand™ Universal Wrenches, Metric

6 Point

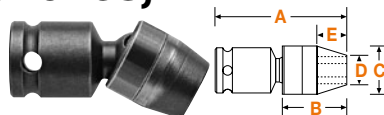

Part Number 6 Point	Hex Opening mm	Overall Length (A)	Socket Length (B)	Socket Diameter (C)	Nose End Diameter (D)	Opening Depth (E)
SA-C-57-13M	13	58	25,4	22,2	17,5	11,9
SA-C-57-14M	14	60	27,0	22,2	19,1	13,5
SA-C-58-15M	15	62	28,6	25,4	19,8	14,3
SA-C-58-16M	16	64	30,2	25,4	21,4	15,9
SA-C-58-17M	17	66	31,8	25,4	25,4	17,5
SA-C-58-18M	18	66	31,8	25,4	25,4	17,5
SA-C-510-21M	21	73	34,9	31,8	28,6	16,3
SA-C-510-22M	22	73	34,9	31,8	31,8	16,3

Universal wrenches must not be used with impact drivers. Maximum operating angle is 30°.

1/2" Square Drive Universal Wrench Set, Metric

6 Point



APU56M 6 pieces, standard length:
13mm, 14mm, 15mm,
16mm, 17mm, 18mm

1/2" Square Drive Universal Wrenches, Metric – Extension

6 Point, Standard and Tension Type



Part Number Standard	Part Number Tension	Hex Opening mm	Shank Length (A)	Socket Length (B)	Socket Diameter (C)	Nose End Diameter (D)	Clearance Depth (E)
-	KN-7-12M-6	12	152	23,8	22,2	17,5	10,3
-	KN-7-12M-9	12	229	23,8	22,2	17,5	10,3
KH-7-13M-3	-	13	76	25,4	22,2	17,5	11,9
KH-7-13M-4	-	13	102	25,4	22,2	17,5	11,9
KH-7-13M-6	KN-7-13M-6	13	152	25,4	22,2	17,5	11,9
KH-7-13M-9	KN-7-13M-9	13	229	25,4	22,2	17,5	11,9
-	KN-7-13M-12	13	305	25,4	22,2	17,5	11,9
KH-7-14M-6	KN-7-14M-6	14	152	27,0	22,2	19,1	13,5
-	KN-7-14M-9	14	229	27,0	22,2	19,1	13,5
KH-8-15M-3	-	15	76	28,6	25,4	19,8	14,3
KH-8-15M-6	KN-8-15M-6	15	152	28,6	25,4	19,8	14,3
KH-8-15M-9	KN-8-15M-9	15	229	28,6	25,4	19,8	14,3
-	KN-8-15M-12	15	305	28,6	25,4	19,8	14,3
KH-8-16M-3	-	16	76	30,2	25,4	21,4	15,9
KH-8-16M-4	-	16	102	30,2	25,4	21,4	15,9
KH-8-16M-9	KN-8-16M-9	16	229	30,2	25,4	21,4	15,9
KH-8-16M-12	KN-8-16M-12	16	305	30,2	25,4	21,4	15,9
KH-8-17M-3	-	17	76	31,8	25,4	25,4	17,5
KH-8-17M-4	-	17	102	31,8	25,4	25,4	17,5
KH-8-17M-6	KN-8-17M-6	17	152	31,8	25,4	25,4	17,5
KH-8-17M-9	KN-8-17M-9	17	229	31,8	25,4	25,4	17,5
KH-8-18M-3	-	18	76	31,8	25,4	25,4	17,5
KH-8-18M-4	-	18	102	31,8	25,4	25,4	17,5
KH-8-18M-6	KN-8-18M-6	18	152	31,8	25,4	25,4	17,5
KH-8-18M-9	KN-8-18M-9	18	229	31,8	25,4	25,4	17,5
-	KN-8-18M-12	18	305	31,8	25,4	25,4	17,5
KH-10-19M-3	-	19	76	34,9	31,8	26,2	16,3
KH-10-19M-6	-	19	152	34,9	31,8	26,2	16,3
KH-10-19M-9	-	19	229	34,9	31,8	26,2	16,3
KH-10-19M-12	-	19	305	34,9	31,8	26,2	16,3

Universal wrenches must not be used with impact drivers. Maximum operating angle is 30°.

1/2" Sq. Dr. IronBand™ Univ. Wrenches, Metric – Extension

6 Point, Standard and Tension Type



Part Number Standard	Part Number Tension	Hex Opening mm	Shank Length (A)	Socket Length (B)	Socket Diameter (C)	Nose End Diameter (D)	Clearance Depth (E)
KHW-C-7-13m-6	KNW-C-7-13m-6	13	152	25,4	22,2	17,5	11,9
KHW-C-7-13m-9	KNW-C-7-13m-9	13	229	25,4	22,2	17,5	11,9
KHW-C-7-14m-6	KNW-C-7-14m-6	14	152	27,0	22,2	19,1	13,5
KHW-C-8-15m-6	KNW-C-8-15m-6	15	152	28,6	25,4	19,8	14,3
KHW-C-8-15m-9	-	15	229	28,6	25,4	19,8	14,3
-	KNW-C-8-15m-12	15	305	28,6	25,4	19,8	14,3
KHW-C-8-16m-9	KNW-C-8-16m-9	16	229	30,2	25,4	21,4	15,9
KHW-C-8-17m-6	KNW-C-8-17m-6	17	152	31,8	25,4	25,4	17,5
KHW-C-8-17m-9	KNW-C-8-17m-9	17	229	31,8	25,4	25,4	17,5
KHW-C-8-18m-6	KNW-C-8-18m-6	18	152	31,8	25,4	25,4	17,5
KHW-C-8-18m-9	KNW-C-8-18m-9	18	229	31,8	25,4	25,4	17,5

Universal wrenches must not be used with impact drivers. Maximum operating angle is 30°.

1/2" Square Drive Socket Head Bits, Metric

Complete, Adapter Only, Insert Only

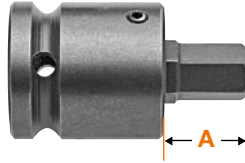

Complete	Part Number		Hex Size	Overall Length		Length of Insert (A)	
	Adapter Only	Insert Only		In.	mm	In.	mm
SZ-5-7-8MM	SC-514	SZ-7-8MM	8MM	2 1/2	64	1 3/8	35
SZ-5-7-10MM	SC-514	SZ-7-10MM	10MM	2 1/2	64	1 3/8	35
SZ-5-7-12MM	SC-514	SZ-7-12MM	12MM	2 1/2	64	1 3/8	35
SZ-5-7-14MM	SC-514	SZ-7-14MM	14MM	2 1/2	64	1 3/8	35
SZ-5-10-14MM	RP-520	SZ-10-14MM	14MM	2 1/2	64	1 9/16	40
SZ-5-10-17MM	RP-520	SZ-10-17MM	17MM	2 1/2	64	1 9/16	40

Für eine vollständige Auflistung siehe Seite 20.

1/2" Square Drive Sockets For Spline Fasteners

Standard & Long Length

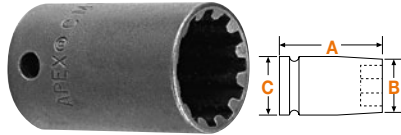

Part Number	Spline Size	Nominal Size	Overall Length (A)		Diameter Nose End (B)		Diameter Drive End (C)	
			In.	mm	In.	mm	In.	mm
CMS-5416	16	1/2	1 1/4	32	23/32	18	7/8	22
CMS-5422	22	11/16	1 1/2	38	31/32	25	31/32	25
CMS-5426	26	13/16	1 1/2	38	1 1/8	29	1 1/8	29
CMS-5430	30	15/16	1 1/2	38	1 1/4	32	1 1/4	32

Apex spline sockets conform to military specifications MS-37787 and MIL-W-8982C.

1/2" Square Drive Torx® Sockets

For External Torx Screws

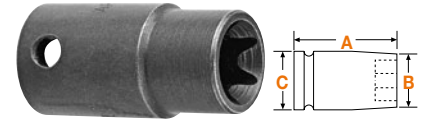

Part Number	Driver Size	Overall Length (A)		Diameter Nose End (B)		Diameter Drive End (C)	
		In.	mm	In.	mm	In.	mm
TX-5110	E-10	1 1/2	38	9/16	13	1	25
TX-5112	E-12	1 1/2	38	5/8	16	1	25
TX-5114	E-14	1 1/2	38	11/16	18	1	25
TX-5116	E-16	1 1/2	38	13/16	21	1	25
TX-5118	E-18	1 1/2	38	7/8	22	1	25
TX-5120	E-20	1 1/2	38	1	25	1 3/16	30
TX-5124	E-24	1 1/2	38	1 5/16	33	1 5/16	33

For External Torx Screws, Thin Wall



Part Number	Size	Overall Length (A)		Diameter Nose End (B)		Diameter Drive End (C)	
		In.	mm	In.	mm	In.	mm
TX-5408	E-8	1 1/2	38	3/8	10	7/8	22
TX-5410	E-10	1 1/2	38	1/2	13	7/8	22
TX-5412	E-12	1 1/2	38	9/16	14	7/8	22
TX-5414	E-14	1 1/2	38	5/8	16	7/8	22
TX-5416	E-16	1 1/2	38	7/8	22	7/8	22
TX-5418	E-18	1 1/2	38	15/16	24	15/16	24
TX-5420	E-20	1 1/2	38	1 1/16	27	1 1/16	27

1/2" Square Drive Extensions

1 23/32" to 18" (44mm to 457mm) Length



Part Number	Male Square In.	Type of Lock	Overall Length mm	
			In.	mm
EX-504	1/2	Pin	1 23/32	44
EX-504-B	1/2	Ball	1 23/32	44
EX-508-2	1/2	Pin	2	51
EX-508-B-2	1/2	Ball	2	51
EX-508-3	1/2	Pin	3	76
EX-508-B-3	1/2	Ball	3	76
EX-508-4	1/2	Pin	4	102
EX-508-B-4	1/2	Ball	4	102
EX-508-5	1/2	Pin	5	127
EX-508-B-5	1/2	Ball	5	127
EX-508-6	1/2	Pin	6	152
EX-508-B-6	1/2	Ball	6	152
EX-508-8	1/2	Pin	8	203
EX-508-B-8	1/2	Ball	8	203
EX-508-9	1/2	Pin	9	229
EX-508-B-9	1/2	Ball	9	229
EX-508-10	1/2	Pin	10	254
EX-508-B-10	1/2	Ball	10	254
EX-508-12	1/2	Pin	12	305
EX-508-B-12	1/2	Ball	12	305
EX-508-15	1/2	Pin	15	381
EX-508-B-15	1/2	Ball	15	381
EX-508-16	1/2	Pin	16	406
EX-508-18	1/2	Pin	18	457

1/2" Square Drive Adapters

1/4" to 5/8" Male Square

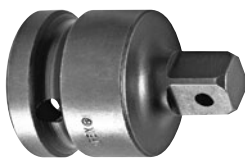

Part Number	Male Square In.	Female Square In.	Type of Lock	Overall Length In.	Overall Length mm
EX-260	1/4	1/2	Pin	1 1/2	38
EX-260-B	1/4	1/2	Ball	1 1/2	38
EX-258-B-2	1/4	1/2	Ball	2	51
EX-258-4	1/4	1/2	Pin	4	102
EX-375	3/8	1/2	Pin	1 1/2	38
EX-375-B	3/8	1/2	Ball	1 1/2	38
EX-377-2	3/8	1/2	Pin	2	51
EX-377-B-2	3/8	1/2	Ball	2	51
EX-377-3	3/8	1/2	Pin	3	76
EX-377-B-3	3/8	1/2	Ball	3	76
EX-377-4	3/8	1/2	Pin	4	102
EX-377-B-4	3/8	1/2	Ball	4	102
EX-377-5	3/8	1/2	Pin	5	127
EX-377-B-5	3/8	1/2	Ball	5	127
EX-377-6	3/8	1/2	Pin	6	152
EX-377-B-6	3/8	1/2	Ball	6	152
EX-377-8	3/8	1/2	Pin	8	203
EX-377-B-9	3/8	1/2	Ball	9	229
EX-377-10	3/8	1/2	Pin	10	254
EX-377-B-10	3/8	1/2	Ball	10	254
EX-377-12	3/8	1/2	Pin	12	305
EX-377-B-12	3/8	1/2	Ball	12	305
EX-377-15	3/8	1/2	Pin	15	381

1/2" Square Drive Universal Adapters

3/8" to 3/4" Male Square



Part Number	Male Square In.	Female Square In.	Type of Lock	Overall Length In.	Overall Length mm	Overall Length mm
MF-39	3/8	1/2	Pin	2 9/16	65	7/8 22
MF-39B	3/8	1/2	Ball	2 9/16	65	7/8 22
MF-50	1/2	1/2	Pin	2 11/16	68	1 25
MF-50B	1/2	1/2	Ball	2 11/16	68	1 25
MF-55	1/2	1/2	Pin	3 1/16	78	1 1/4 32
MF-55B	1/2	1/2	Ball	3 1/16	78	1 1/4 32
MF-70	3/4	1/2	7/32 Drill Hole	3 5/8	92	1 1/2 38
MF-70B	3/4	1/2	Ball	3 5/8	92	1 1/2 38

Universal wrenches must not be used with impact drivers.
Maximum operating angle is 30°.-

1/2" Square Drive Universal Adapters - Extension

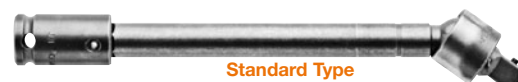

Standard Type

1/2" Male Square

Part Number Standard	Tension	Male Square In.	Square Female In.	Type of Lock	Largest Dia. In.	Largest Dia. mm
KHM-37-6	KNM-37-6	3/8	1/2	Pin	3/4	19
KHM-38-6	KNM-38-6	3/8	1/2	Pin	7/8	22
KHM-50-6	KNM-50-6	1/2	1/2	Pin	1	25
KHM-50-B-6	KNM-50-B-6	1/2	1/2	Ball	1	25

Universal wrenches must not be used with impact drivers.
Maximum operating angle is 30°.
Standard lengths are 3", 6", 9" and 12" (76, 152, 229 and 305mm)

1/2" Square Drive Adapters

5/8" to 3/4" Male Square



Part Number	Male Square In.	Female Square In.	Type of Lock	Overall Length In.	Overall Length mm
EX-623	5/8	1/2	Pin	1 1/2	38
EX-623-B	5/8	1/2	Ball	1 1/2	38
EX-626-3	5/8	1/2	Pin	3	76
EX-751	3/4	1/2	7/32 Drill Hole	1 13/16	46
EX-751-B	3/4	1/2	Ball	1 13/16	46

If the tool you need does not appear in this catalog, give us a call. The odds are, we may have what you need as a non-catalog item. If not, our experienced staff of tooling experts can design and manufacture "specials" to meet the needs of your specific application.

Give us a call at +49 7363-81-129 or visit our website www.apexpowertools.eu.

5/8" Square Drive Sockets, SAE

6 Point & Double Hex, Standard Length

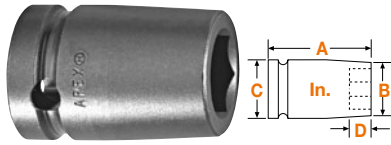

Part Number 6 Point	Part Number 12 Point	Hex Opening In.	Overall Length (A)	Diameter Nose End (B)	Diameter Drive End (C)	Opening Depth (D)
6118	-	9/16	1 7/8	7/8	1 1/4	7/16
6120	6120-D	5/8	1 7/8	1	1 1/4	7/16
6122	-	11/16	1 7/8	1 1/8	1 1/4	7/16
6124	-	3/4	1 7/8	1 1/4	1 1/4	15/32
6128	-	7/8	1 7/8	1 3/8	1 3/8	9/16
6134	-	1 1/16	2	1 5/8	1 5/8	11/16
6136	-	1 1/8	2	1 5/8	1 5/8	3/4
6140	-	1 1/4	2	1 7/8	1 7/8	13/16
6142	-	1 5/16	2	2	2	13/16
6144	-	1 3/8	2 1/8	2	2	13/16
6146	-	1 7/16	2 1/8	2 1/8	2 1/8	15/16
6148	-	1 1/2	2 1/4	2 1/8	2 1/8	1

6 Point & Double Hex, Thin Wall Standard Length



Part Number 6 Point	Hex Opening In.	Overall Length (A)	Diameter Nose End (B)	Diameter Drive End (C)	Opening Depth (D)
6426	13/16	1 7/8	1 1/8	1 1/4	17/32
6430	15/16	2	1 5/16	1 5/16	5/8

6 Point & Double Hex, Extra Long Length



Part Number 6 Point	Hex Opening In.	Overall Length (A)	Diameter Nose End (B)	Diameter Drive End (C)	Opening Depth (D)
6320	5/8	3 1/2	1	1 1/4	7/16
6322	11/16	3 1/2	1 1/8	1 1/4	7/16
6324	3/4	3 1/2	1 1/4	1 1/4	15/32
6326	13/16	3 1/2	1 1/4	1 1/4	17/32
6330	15/16	3 1/2	1 1/2	1 1/2	5/8
6336	1 1/8	3 1/2	1 5/8	1 5/8	3/4
6340	1 1/4	3 1/2	1 7/8	1 7/8	13/16
6342	1 5/16	3 1/2	2	2	13/16
6344	1 3/8	3 1/2	2	2	13/16
6348	1 1/2	3 1/2	2 1/8	2 1/8	1

6 Point & Double Hex, Thin Wall, Extra Long Length



Part Number 6 Point	Part Number 12 Point	Hex Opening mm	Overall Length (A)	Diameter Nose End (B)	Diameter Drive End (C)	Opening Depth (D)
-	6520-D	5/8	3 1/2	15/16	1 1/4	7/16
6524	6524-D	3/4	3 1/2	1 1/16	1 1/4	15/32
-	6528-D	7/8	3 1/2	1 3/16	1 1/4	9/16

Surface Drive & Fast Lead, Standard Length



Part No. Surface Drive	Part Fast Lead	Hex Opening mm	Overall Length (A)	Diameter Nose End (B)	Diameter Drive End (C)	Opening Depth (D)
SF-6118	-	9/16	1 7/8	7/8	1 1/4	7/16
SF-6120	-	5/8	1 7/8	1	1 1/4	7/16
SF-6124	FL-6124	3/4	1 7/8	1 1/4	1 1/4	15/32
SF-6424*	-	3/4	1 7/8	1 1/16	1 1/4	15/32
SF-6128	FL-6128	7/8	1 7/8	1 3/8	1 3/8	9/16

*Thin Wall

Surface Drive & Fast Lead, Thin Wall, Extra Long Length



Part No. Surface Drive	Part Fast Lead	Hex Opening mm	Overall Length (A)	Diameter Nose End (B)	Diameter Drive End (C)	Opening Depth (D)
SF-6320	-	5/8	3 1/2	1	1 1/4	7/16
SF-6324	FL-6324	3/4	3 1/2	1 1/4	1 1/4	15/32
SF-6524*	-	3/4	3 1/2	1 1/16	1 1/4	15/32
SF-6326	-	13/16	3 1/2	1 1/4	1 1/4	17/32
SF-6328	-	7/8	3 1/2	1 3/8	1 3/8	9/16
SF-6330	-	15/16	3 1/2	1 1/2	1 1/2	5/8

*Thin Wall

5/8" Square Drive Sockets, Metric

6 Point & Surface Drive, Standard Length

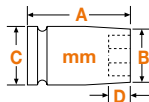

Part Number 6 Point	Part No. Surface- Drive	Hex Opening In.	Overall Length (A)	Diameter Nose End (B)	Diameter Drive End (C)	Opening Depth (D)
-	SF-15MM16	15	48	23,8	31,8	11,1
16MM16	SF-16MM16	16	48	25,4	31,8	11,1
17MM16	SF-17MM16	17	48	28,6	31,8	11,1
18MM16	SF-18MM16	18	48	28,5	31,8	11,1
-	SF-19MM16	19	48	31,8	31,8	11,9
21MM16	SF-21MM16	21	48	31,8	31,8	13,5
-	SF-22MM16	22	48	34,9	34,9	14,3
24MM16	SF-24MM16	24	51	38,1	38,1	15,9

6 Point & Surface Drive, Extra Long Length

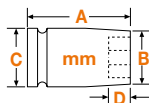
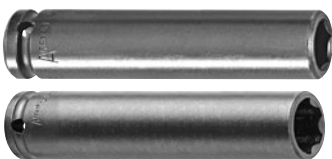

Part Number 6 Point	Part No. Surface- Drive	Hex Opening In.	Overall Length (A)	Diameter Nose End (B)	Diameter Drive End (C)	Opening Depth (D)
-	SF-15MM36	15	89	23,8	31,8	11,1
17MM36	-	17	89	25,4	31,8	11,1
-	SF-18MM36	18	89	28,6	31,8	11,1
19MM36	SF-19MM36	19	89	31,8	31,8	11,9
21MM36	SF-21MM36	21	89	31,8	31,8	13,5
-	SF-22MM36	22	89	34,9	34,9	14,3
24MM36	SF-24MM36	24	89	38,1	38,1	15,9

5/8" Square Drive Extensions

1 7/8" to 15" (48mm to 381mm) Length



Part Number	Male Square In.	Type of Lock	Overall Length In.	Overall Length mm
EX-624	5/8	Pin	1 7/8	48
EX-624-B	5/8	Ball	1 7/8	48
EX-627-3	5/8	Pin	3	76
EX-627-4	5/8	Pin	4	102
EX-627-6	5/8	Pin	6	152
EX-627-8	5/8	Pin	8	203
EX-627-10	5/8	Pin	10	254
EX-627-12	5/8	Pin	12	305

5/8" Square Drive Adapters

1/2" to 3/4" Male Square



Part Number	Male Square In.	Female Square In.	Type of Lock	Overall Length In.	Overall Length mm
EX-505	1/2	5/8	Pin	1 7/8	48
EX-505-B	1/2	5/8	Ball	1 7/8	48
EX-509-3	1/2	5/8	Pin	3	76
EX-509-4	1/2	5/8	Pin	4	102
EX-509-5	1/2	5/8	Pin	5	127
EX-509-6	1/2	5/8	Pin	6	152
EX-509-10	1/2	5/8	Pin	10	254
EX-509-12	1/2	5/8	Pin	12	305
EX-752	3/4	5/8	7/32 Drill Hole	1 7/8	48
EX-752-B	3/4	5/8	Ball	1 7/8	48

5/8" Square Drive Universal Adapters

1/2" to 5/8" Male Square



Part Number	Male Square In.	Female Square In.	Type of Lock	Overall Length In.	Overall Length mm	Overall Length In.	Overall Length mm
MF-51	1/2	5/8	Pin	3 5/16	84	1 1/4	32
MF-62	5/8	5/8	Pin	3 1/4	83	1 1/4	32
MF-62B	5/8	5/8	Ball	3 1/4	83	1 1/4	32

Universal wrenches must not be used with impact drivers.
Maximum operating angle is 30°.-

3/4" Square Drive Sockets, SAE

6 Point & Double Hex, Standard Length

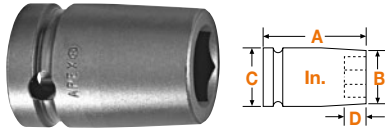

Part Number 6 Point	Part Number 12 Point	Hex Opening In.	Overall Length (A)	Diameter Nose End (B)	Diameter Drive End (C)	Opening Depth (D)
7120	7120-D	5/8	2	1 1/16	1 1/2	7/16
7122	7122-D	11/16	2	1 1/8	1 1/2	7/16
7124	7124-D	3/4	2	1 1/4	1 1/2	15/32
7128	7128-D	7/8	2	1 1/2	1 1/2	9/16
7130	7130-D	15/16	2	1 1/2	1 1/2	5/8
7132	7132-D	1	2	1 5/8	1 5/8	5/8
7134	7134-D	1 1/16	2	1 3/4	1 3/4	11/16
7136	7136-D	1 1/8	2 1/8	1 3/4	1 3/4	3/4
7140	7140-D	1 1/4	2 1/8	2	1 3/4	13/16
7142	7142-D	1 5/16	2 1/8	2	1 3/4	13/16
7144	-	1 3/8	2 1/8	2 1/8	2 1/8	13/16
7146	-	1 7/16	2 1/4	2 1/4	2 1/8	15/16
7148	7148-D	1 1/2	2 1/4	2 1/4	2 1/8	1
7152	7152-D	1 5/8	2 1/4	2 1/2	2 1/8	1 1/8
7154	7154-D	1 11/16	2 1/4	2 1/2	2 1/8	1 1/8
7156	-	1 3/4	2 1/4	2 5/8	2 1/8	1 1/8
7158	-	1 13/16	2 1/4	2 3/4	2 1/8	1 1/4
7160	7160-D	1 7/8	2 1/4	2 3/4	2 1/8	1 1/4
7164	7164-D	2	2 3/8	2 7/8	2 1/8	1 3/8
7168	-	2 1/8	2 3/8	3 1/8	2 1/8	1 3/8
7170	7170-D	2 3/16	2 1/2	3 1/8	2 1/8	1 1/2
7172	7172-D	2 1/4	2 1/2	3 1/4	2 1/8	1 1/2
7176	-	2 3/8	2 5/8	3 1/2	2 1/8	1 5/8
7180	7180-D	2 1/2	2 5/8	3 1/2	2 1/8	1 5/8

6 Point & Double Hex, Thin Wall Standard Length



Part Number 6 Point	Part Number 12 Point	Hex Opening In.	Overall Length (A)	Diameter Nose End (B)	Diameter Drive End (C)	Opening Depth (D)
7424	7424-D	3/4	2	1 1/8	1 3/8	15/32
7426	-	13/16	2	1 1/4	1 3/8	17/32
7428	7428-D	7/8	2	1 5/16	1 3/8	9/16
7430	7430-D	15/16	2	1 3/8	1 3/8	5/8
7432	-	1	2	1 7/16	1 7/16	5/8
7434	-	1 1/16	2	1 1/2	1 1/2	11/16
7436	-	1 1/8	2 1/8	1 5/8	1 5/8	3/4
7438	-	1 3/16	2 1/8	1 5/8	1 5/8	3/4
7442	7442-D	1 5/16	2 1/8	1 7/8	1 3/4	13/16
7446	-	1 7/16	2 1/4	2	1 3/4	15/16
7448	-	1 1/2	2 1/4	2 1/8	2 1/8	1
7454	-	1 11/16	2 1/4	2 3/8	2 1/8	1 1/8
7456	-	1 3/4	2 1/4	2 7/16	2 1/8	1 1/8

6 Point & Double Hex, Extra Long Length



Part Number 6 Point	Part Number 12 Point	Hex Opening In.	Overall Length (A)	Diameter Nose End (B)	Diameter Drive End (C)	Opening Depth (D)
7324SKT	7324-D	3/4	4	1 1/4	1 1/2	15/32
7328	-	7/8	4	1 7/16	1 1/2	9/16
7330	7330-D	15/16	4	1 1/2	1 1/2	5/8
7332	7332-D	1	4	1 1/2	1 1/2	5/8
7334	-	1 1/16	4	1 5/8	1 5/8	11/16
7336	7336-D	1 1/8	4	1 3/4	1 3/4	3/4
7340	-	1 1/4	4	1 7/8	1 3/4	13/16
7342	-	1 5/16	4	2	1 3/4	13/16
7346	-	1 7/16	4	2 1/8	2 1/8	15/16
7348	-	1 1/2	4	2 1/4	2 1/8	1
7352	-	1 5/8	4	2 1/2	2 1/8	1 1/8
7356	-	1 3/4	4	2 5/8	2 1/8	1 1/8
7358	-	1 13/16	4	2 3/4	2 1/8	1 1/4
7360	-	1 7/8	4	2 3/4	2 1/8	1 1/4
7362	-	1 15/16	4	2 3/4	2 1/8	1 1/4
7364	-	2	4 1/8	2 7/8	2 1/8	1 3/8
7372	-	2 1/4	4 1/4	3 1/4	2 1/8	1 1/2

6 Point & Double Hex, Thin Wall, Extra Long Length



Part Number 6 Point	Part Number 12 Point	Hex Opening In.	Overall Length (A)	Diameter Nose End (B)	Diameter Drive End (C)	Opening Depth (D)
7524	-	3/4	4	1 1/8	1 3/8	15/32
7528	-	7/8	4	1 3/8	1 3/8	9/16
7530	7530-D	15/16	4	1 3/8	1 3/8	5/8
7536	7536-D	1 1/8	4	1 5/8	1 5/8	3/4
7540	-	1 1/4	4	1 3/4	1 3/4	13/16
7542	-	1 5/16	4	1 7/8	1 3/4	13/16
7548	-	1 1/2	4	2 1/8	2 1/8	1
7552	-	1 5/8	4	2 1/4	2 1/8	1 1/8
7556	-	1 3/4	4	2 1/2	2 1/8	1 1/8

3/4" Square Drive Sockets For SAE Square Nuts

Single Square & Double Square, Standard Length

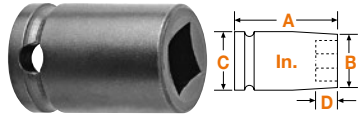

Part Number	Hex Opening In.	Overall Length (A)	Diameter Nose End (B)	Diameter Drive End (C)	Opening Depth (D)
7624	3/4	2	1 1/2	1 1/2	15/32
7628	7/8	2	1 3/4	1 3/4	5/8
7630	15/16	2 1/8	1 7/8	1 3/4	5/8
7632	1	2 1/8	2	1 3/4	5/8
7636	1 1/8	2 1/8	2 1/8	2 1/8	3/4

3/4" Square Drive Universal Wrenches, SAE

6 Point

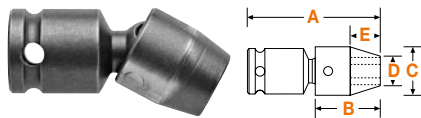

Part Number	Hex Opening In.	Overall Length (A) In.	Socket Length (B) In.	Socket Diameter (C) In.	Nose End Diameter (D) In.	Clearance Depth (E) In.
SA-535	15/16	3 25/32	1 3/4	1 1/2	1 3/8	29/32
SA-601	15/16	4 1/32	1 15/16	1 3/4	1 1/2	29/32
SA-537	1 1/16	3 29/32	1 7/8	1 5/8	1 5/8	1 1/32
SA-603	1 1/16	4 3/32	2	1 3/4	1 5/8	31/32
SA-538	1 1/8	3 29/32	1 7/8	1 5/8	1 5/8	1 1/32
SA-604	1 1/8	4 5/32	2 1/16	1 3/4	1 3/4	1 1/32
SA-606	1 1/4	4 7/32	2 1/8	1 7/8	1 7/8	1 3/32
SA-607	1 5/16	4 7/32	2 1/8	1 7/8	1 7/8	1 3/32
SA-609	1 7/16	4 11/32	2 1/4	2 1/8	2 1/8	1 5/32
SA-610	1 1/2	4 11/32	2 1/4	2 1/4	2 1/4	1 5/32
SA-712	1 5/8	4 11/32	2 3/8	2 3/8	2 3/8	1 3/16
SA-716	1 7/8	4 11/32	2 3/8	2 5/8	2 5/8	1 3/16

Universal wrenches must not be used with impact drivers.
Maximum operating angle is 30°.

3/4" Square Drive Sockets, Metric

6 Point, Standard Length

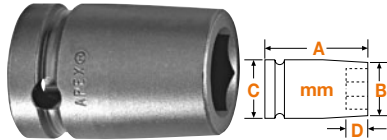

Part Number 6 Point	Hex Opening In.	Overall Length (A)	Diameter Nose End (B)	Diameter Drive End (C)	Opening Depth (D)
17MM17	17	51	31,8	38,1	11,2
18MM17	18	51	31,8	38,1	11,2
19MM17	19	51	31,8	38,1	11,9
20MM17	20	51	33,3	38,1	11,9
21MM17	21	51	34,9	38,1	13,5
22MM17	22	51	38,1	38,1	14,3
22MM47*	22	51	33,3	34,9	14,3
24MM17	24	51	38,1	38,1	15,9
24MM47*	24	51	34,9	34,9	15,9
26MM17	26	51	41,3	41,3	15,9
27MM17	27	51	44,4	44,4	17,5
27MM47*	27	51	38,1	38,1	17,5
29MM17	29	54	47,6	44,4	19,1
30MM17	30	54	47,6	44,4	19,1
30MM47*	30	54	41,3	41,3	19,1
32MM17	32	54	50,8	44,4	20,6
32MM47*	32	54	44,4	44,4	20,6
33MM17	33	54	50,8	44,4	20,6
36MM17	36	57	57,1	54,0	23,8
37MM17	37	57	57,1	54,0	23,8
41MM17	41	57	63,5	54,0	31,8
46MM17	46	57	69,9	54,0	31,8

*Thin Wall

6 Point, Extra Long Length



Part Number 6 Point	Hex Opening In.	Overall Length (A)	Diameter Nose End (B)	Diameter Drive End (C)	Opening Depth (D)
21MM37	21	102	34,9	38,1	13,5
21MM57*	21	102	34,9	34,9	13,5
22MM57*	22	102	34,9	34,9	14,3
24MM37	24	102	38,1	38,1	15,9
24MM57*	24	102	34,9	34,9	15,9
25MM37	25	102	38,1	38,1	15,9
27MM37	27	102	41,3	41,3	17,5
27MM57*	27	101,6	38,1	38,1	17,5
28MM37	28	101,6	44,4	44,4	19,1
29MM37	29	101,6	44,4	44,4	19,1
30MM37	30	101,6	44,4	44,4	19,1
30MM57*	30	101,6	42,9	42,9	19,1
32MM37	32	101,6	47,6	44,4	20,6
33MM37	33	101,6	50,8	44,4	20,6
34MM37	34	101,6	54,0	54,0	20,6
36MM37	36	101,6	54,0	54,0	23,8
41MM37	41	101,6	63,5	54,0	28,6

*Thin Wall

3/4" Square Drive Extensions

2 1/4" to 15" (57mm to 381mm) Length



Part Number	Male Square In.	Type of Lock	Overall Length In.	mm
EX-753	3/4	7/32 Drill Hole	2 1/4	57
EX-753-B	3/4	Ball	2 1/4	57
EX-755-4	3/4	7/32 Drill Hole	4	102
EX-755-B-4	3/4	Ball	4	102
EX-755-6	3/4	7/32 Drill Hole	6	152
EX-755-B-6	3/4	Ball	6	152
EX-755-8	3/4	7/32 Drill Hole	8	203
EX-755-B-8	3/4	Ball	8	203
EX-755-10	3/4	7/32 Drill Hole	10	254
EX-755-12	3/4	7/32 Drill Hole	12	305
EX-755-B-12	3/4	Ball	12	305
EX-755-15	3/4	7/32 Drill Hole	15	381
EX-755-B-15	3/4	Ball	15	381

3/4" Square Drive Adapters



1/2" to 1" Male Square

Part Number	Male Square In.	Female Square In.	Type of Lock	Overall Length In.	mm
EX-506	1/2	3/4	Pin	2	51
EX-506-B	1/2	3/4	Ball	2	51
EX-510-3	1/2	3/4	Pin	3	76
EX-510-B-3	1/2	3/4	Ball	3	76
EX-510-4	1/2	3/4	Pin	4	102
EX-510-B-4	1/2	3/4	Ball	4	102
EX-510-B-5	1/2	3/4	Ball	5	127
EX-510-6	1/2	3/4	Pin	6	152
EX-510-B-6	1/2	3/4	Ball	6	152
EX-510-8	1/2	3/4	Pin	8	203
EX-510-B-8	1/2	3/4	Ball	8	203
EX-625	5/8	3/4	Pin	2	51
EX-625-B	5/8	3/4	Ball	2	51
EX-628-3	5/8	3/4	Pin	3	76
EX-1000	1	3/4	9/32 Drill Hole	2 9/16	65
EX-1000-B	1	3/4	Ball	2 9/16	65

3/4" Square Drive Universal Adapters



3/4" Male Square

Part Number	Male Square In.	Female Square In.	Type of Lock	Overall Length In.	mm	Largest Diameter In.	mm
MF-75	3/4	3/4	7/32 Drill Hole	4	102	1 1/2	38
MF-75B	3/4	3/4	Ball	4	102	1 1/2	38
MF-76	3/4	3/4	7/32 Drill Hole	4 3/8	111	1 3/4	45
MF-76B	3/4	3/4	Ball	4 3/8	111	1 3/4	45

Universal wrenches must not be used with impact drivers.
Maximum operating angle is 30°.

1" Square Drive Sockets, SAE

6 Point & Double Hex, Standard Length

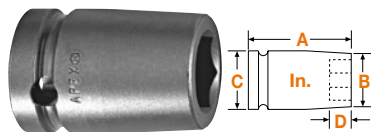

Part Number 6 Point	Part Double 12 Point	Hex Opening In.	Overall Length (A)	Diameter Nose End (B)	Diameter Drive End (C)	Opening Depth (D)
-	8124-D	3/4	2 1/8	1 5/16	2	13/16
8126	-	13/16	2 1/8	1 3/8	2	13/16
-	8128-D	7/8	2 1/8	1 1/2	2	13/16
-	8130-D	15/16	2 1/8	1 1/2	2	13/16
-	8132-D	1	2 1/8	1 5/8	2	13/16
-	8134-D	1 1/16	2 1/8	1 11/16	2	13/16
-	8136-D	1 1/8	2 1/8	1 3/4	2	13/16
8138	8138-D	1 3/16	2 1/8	2 1/8	2	13/16
-	8140-D	1 1/4	2 1/8	2 1/8	2 1/8	13/16
8142	8142-D	1 5/16	2 1/8	2 1/8	2 1/8	13/16
-	8144-D	1 3/8	2 1/8	2 1/8	2 1/8	13/16
-	8146-D	1 7/16	2 1/4	2 1/4	2 1/8	15/16
8148	8148-D	1 1/2	2 1/4	2 1/4	2 1/8	15/16
-	8150-D	1 9/16	2 1/4	2 3/8	2 1/8	15/16
8152	-	1 5/8	2 3/8	2 1/2	2 1/8	15/16
8160	-	1 7/8	2 1/2	2 3/4	2 5/8	1 1/16
8162	8162-D	1 15/16	2 1/2	2 7/8	2 5/8	1 1/16
8170	-	2 3/16	2 3/4	3 1/4	3 1/4	1 5/16
8172	-	2 1/4	2 3/4	3 1/4	3 1/4	1 5/16
8174	-	2 5/16	2 3/4	3 3/8	3 1/4	1 3/8
8176	-	2 3/8	2 7/8	3 1/2	3 1/4	1 3/8
8180	-	2 1/2	2 7/8	3 3/4	3 1/4	1 3/8
8186	-	2 11/16	3	4	3 1/4	1 1/2
8188	-	2 3/4	3 1/8	4	3 1/4	1 5/8
8190	-	2 13/16	3 1/8	4	3 1/4	1 5/8

6 Point, Long Length

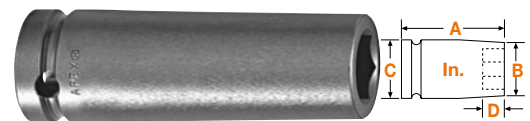

Part Number 6 Point	Hex Opening In.	Overall Length (A)	Diameter Nose End (B)	Diameter Drive End (C)	Opening Depth (D)
8228	7/8	3	1 7/16	2 1/8	9/16
8236	1 1/8	3	1 3/4	2 1/8	3/4
8240	1 1/4	3	2 1/8	2 1/8	13/16

6 Point, Extra Long Length

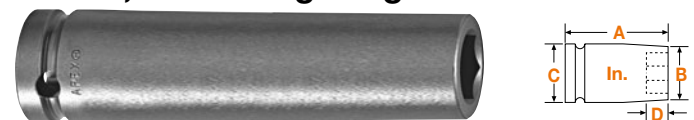

Part Number 6 Point	Hex Opening In.	Overall Length (A)	Diameter Nose End (B)	Diameter Drive End (C)	Opening Depth (D)
8324	3/4	4 1/4	1 1/4	2 1/8	15/32
8326	13/16	4 1/4	1 3/8	2 1/8	17/32
8332	1	4 1/4	1 9/16	2 1/8	5/8
8336	1 1/8	4 1/4	1 3/4	2 1/8	3/4
8338	1 3/16	4 1/4	1 7/8	2 1/8	3/4
8340	1 1/4	4 1/4	2 1/8	2 1/8	13/16
8342	1 5/16	4 1/4	2 1/8	2 1/8	13/16
8346	1 7/16	4 1/4	2 1/4	2 1/8	15/16
8356	1 3/4	4 1/4	2 5/8	2 5/8	1 1/8
8360	1 7/8	4 1/4	2 3/4	2 5/8	1 1/4
8364	2	4 3/8	2 7/8	2 5/8	1 3/8
8370	2 3/16	4 1/2	3 1/8	2 5/8	1 1/2
8378	2 7/16	4 1/2	3 1/2	3 1/4	1 5/8
8380	2 1/2	4 1/2	3 1/2	3 1/4	1 5/8
8382	2 9/16	4 1/2	3 3/4	3 1/4	1 3/4
8384	2 5/8	4 1/2	3 3/4	3 1/4	1 3/4

6 Point & Double Hex, Thin Wall Standard Length

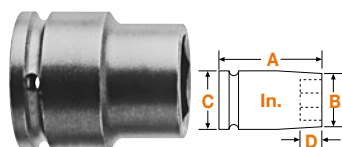

Part Number 6 Point	Part Double 12 Point	Hex Opening In.	Overall Length (A)	Diameter Nose End (B)	Diameter Drive End (C)	Opening Depth (D)
-	8430-D	15/16	2 1/8	1 7/16	1 7/8	13/16
8432	8432-D	1	2 1/8	1 1/2	1 7/8	13/16
8434	-	1 1/16	2 1/8	1 9/16	1 7/8	13/16
8436	-	1 1/8	2 1/8	1 5/8	1 7/8	13/16
8440	8440-D	1 1/4	2 1/8	1 13/16	2	13/16
8442	8442-D	1 5/16	2 1/8	1 7/8	2	13/16
-	8444-D	1 3/8	2 1/8	1 15/16	2	13/16
8448	8448-D	1 1/2	2 1/4	2 1/8	2 1/8	15/16
8454	-	1 11/16	2 3/8	2 3/8	2 1/8	15/16
8456	-	1 3/4	2 3/8	2 7/16	2 1/8	1 1/16
8458	-	1 13/16	2 1/2	2 9/16	2 1/8	1 1/16
8460	-	1 7/8	2 1/2	2 5/8	2 5/8	1 1/16
8464	-	2	2 5/8	2 3/4	2 5/8	1 3/16
-	-	2 1/8	2 5/8	2 15/16	2 5/8	1 3/16
8472	-	2 1/4	2 3/4	3 1/8	2 5/8	1 5/16
8480	-	2 1/2	2 7/8	3 3/8	3 1/4	1 7/16

6 Point, Thin Wall, Extra Long Length

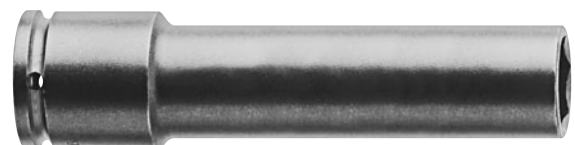

Part Number 6 Point	Hex Opening In.	Overall Length (A)	Diameter Nose End (B)	Diameter Drive End (C)	Opening Depth (D)
8530	15/16	4 1/4	1 1/2	2 1/8	5/8
8536	1 1/8	4 1/4	1 5/8	2 1/8	3/4
8540	1 1/4	4 1/4	1 13/16	2 1/8	13/16
8542	1 5/16	4 1/4	1 7/8	2 1/8	13/16

1" Square Drive Sockets, SAE

Single Square & Double Square, Standard Length

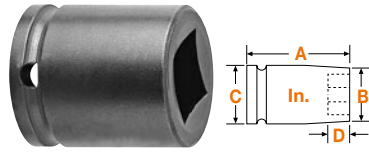

Part No. Single Square	Part No. Double Square	Square Opening In.	Overall Length (A)	Diameter Nose End (B)	Diameter Drive End (C)	Opening Depth (D)
8624	-	3/4	2 1/8	1 5/8	2	13/16
8632	-	1	2 1/8	2 1/8	2 1/8	13/16
8634	-	1 1/16	2 1/8	2 1/8	2 1/8	13/16
8636	-	1 1/8	2 1/4	2 1/4	2 1/8	15/16
8638	8638-D	1 3/16	2 1/4	2 1/4	2 1/8	15/16
8640	8640-D	1 1/4	2 1/4	2 3/8	2 1/8	15/16
8644	-	1 3/8	2 5/16	2 5/8	2 5/8	1
-	8646-D	1 7/16	2 3/8	2 5/8	2 5/8	1
8648	-	1 1/2	2 3/8	2 3/4	2 5/8	1 1/16
-	8652-D	1 5/8	2 1/2	2 7/8	2 5/8	1 1/16

Budd Wheel Sockets

13/16" Square & Combo 13/16" Square 1 1/2" Hex



Part Number	Drive	Overall Length		
		In.	mm	
BW-8626	1" Square	2 1/8	54	13/16"
BW-848	1" Square	3 3/4	95	Combo 13/16" Square - 1 1/2" Hex
BW-848-F	1" Square	3 3/4	95	Combo 13/16" Square - 1 1/2" Hex for mag. wheels

1" Square Drive Sockets, Metric

6 Point, Standard Length

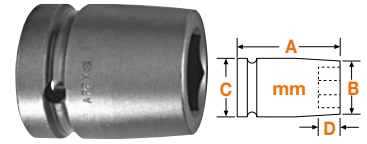

Part Number 6 Point	Hex Opening In.	Overall Length (A)	Diameter Nose End (B)	Diameter Drive End (C)	Opening Depth (D)
21MM18	21	54	34,9	50,8	13,5
24MM18	24	54	38,1	50,8	20,6
27MM18	27	54	42,9	50,8	20,6
29MM18	29	54	47,6	50,8	20,6
30MM18	30	54	50,8	50,8	20,6
30MM48*	30	54	44,4	54,0	20,6
32MM18	32	54	54,0	54,0	20,6
34MM18	34	54	54,0	54,0	20,6
36MM18	36	57	57,1	54,0	23,9
41MM18	41	60	63,5	54,0	23,9
42MM18	42	60	63,5	54,0	23,9
46MM18	46	64	69,8	66,7	26,9
50MM18	50	66	76,2	66,7	30,2

*Thin Wall

6 Point, Long Length



Part Number 6 Point	Hex Opening In.	Overall Length (A)	Diameter Nose End (B)	Diameter Drive End (C)	Opening Depth (D)
24MM38	24	108	38,1	54,0	15,9
27MM38	27	108	41,3	54,0	17,5
28MM38	28	108	44,4	54,0	19,1
33MM38	33	108	54,0	54,0	20,6
36MM38	36	108	54,0	54,0	23,8
37MM38	37	108	57,1	54,0	23,8
46MM38	46	108	69,8	66,7	31,8
50MM38	50	111	73,0	66,7	34,9

1" Square Drive Extensions

2 13/16" to 15" (71mm to 381mm) Length



Part Number	Male Square In.	Type of Lock	Overall Length	
			In.	mm
EX-1001	1	9/32 Drill Hole	2 13/16	71
EX-1001-B	1	Ball	2 13/16	71
EX-1003-4	1	9/32 Drill Hole	4	102
EX-1003-B-4	1	Ball	4	102
EX-1003-6	1	9/32 Drill Hole	6	152
EX-1003-B-6	1	Ball	6	152
EX-1003-8	1	9/32 Drill Hole	8	203
EX-1003-B-8	1	Ball	8	203
EX-1003-10	1	9/32 Drill Hole	10	254
EX-1003-B-10	1	Ball	10	254
EX-1003-12	1	9/32 Drill Hole	12	305
EX-1003-B-12	1	Ball	12	305
EX-1003-15	1	9/32 Drill Hole	15	381
EX-1003-B-15	1	Ball	15	381

1" Square Drive Adapters

3/4" to 1 1/2" Male Square

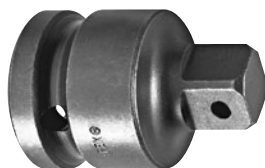

Part Number	Male Square In.	Female Square In.	Type of Lock	Overall Length	
				In.	mm
EX-754	3/4	1	7/32 Drill Hole	2 13/16	71
EX-754-B	3/4	1	Ball	2 13/16	71
EX-756-4	3/4	1	7/32 Drill Hole	4	102
EX-756-6	3/4	1	7/32 Drill Hole	6	152
EX-756-8	3/4	1	7/32 Drill Hole	8	203
EX-1101	1 1/2	1	3/8 Drill Hole	3 9/16	91

1" Square Drive Universal Adapters

3/4" to 1" Male Square



Part Number	Male Square In.	Female Square In.	Type of Lock	Overall Length		Largest Diameter	
				In.	mm	In.	mm
MF-77B	3/4	1	Ball	4 3/4	121	2	51
MF-82	1	1	9/32 Drill Hole	5	127	2	51
MF-82B	1	1	Ball	5	127	2	51

Universal wrenches must not be used with impact drivers.
Maximum operating angle is 30°.-

1 1/2" Square Drive Sockets, SAE

6 Point, Standard Length

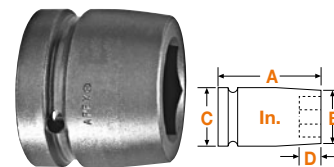

Part Number	Hex Opening In.	Overall Length (A)	Diameter Nose End (B)	Diameter Drive End (C)	Opening Depth (D)
9172	2 1/4	3 1/4	3 3/8	3 1/4	1 1/2

Additional sizes available upon request.

1 1/2" Square Drive Adapters

1" Male Square



Part Number	Male Square In.	Female Square In.	Type of Lock	Overall Length	
				In.	mm
EX-1005	1	1 1/2	9/32 Drill Hole	3 15/16	100
EX-1005-B	1	1 1/2	Ball	3 15/16	100

2 1/2" Square Drive Sockets, SAE

6 Point, Standard Length

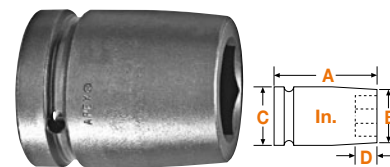

Part Number	Hex Opening In.	Overall Length (A)	Diameter Nose End (B)	Diameter Drive End (C)	Opening Depth (D)
01112	3 1/2	4 3/4	5 1/2	5 1/2	2 1/2

Additional sizes available upon request.

If the tool you need does not appear in this catalog, give us a call. The odds are, we may have what you need as a non-catalog item. If not, our experienced staff of tooling experts can design and manufacture "specials" to meet the needs of your specific application.

Give us a call at +49 7363-81-129 or visit our website www.apexpowertools.eu

APEX® Guard™

Quality Anti-Mar Fastener Tools begin With Quality Fastener Tools.

Apex **μ-Guard** provides a protective barrier between genuine Apex fastener tools and your finely finished workpiece. The free-spinning patent-pending design provides maximum protection for polished and highly sensitive surfaces.

Apex **μ-Guard** covering is made of a thermo plastic urethane (TPU elastomer) which cushions against costly incidental side impacts. It offers the lowest sustained coefficient of friction for maximum tool efficiency. It is also non-removable for tamper resistance.

With Apex **μ-Guard** you get the proven Apex fastener tool fit and performance plus the best protection available against marring and in-system damage.

μ-Guard is your guard against the potential hazards caused by rotational friction.



**If it doesn't say
Apex on the outside,
how can you be sure of
what's on the inside?**

"Cushioning" Effect Minimizes Side Impact Damage



Free-Spinning Design



Virtually Damage Free



Why Apex μ -Guard Anti-Mar Fastener Tools Are The Best Choice

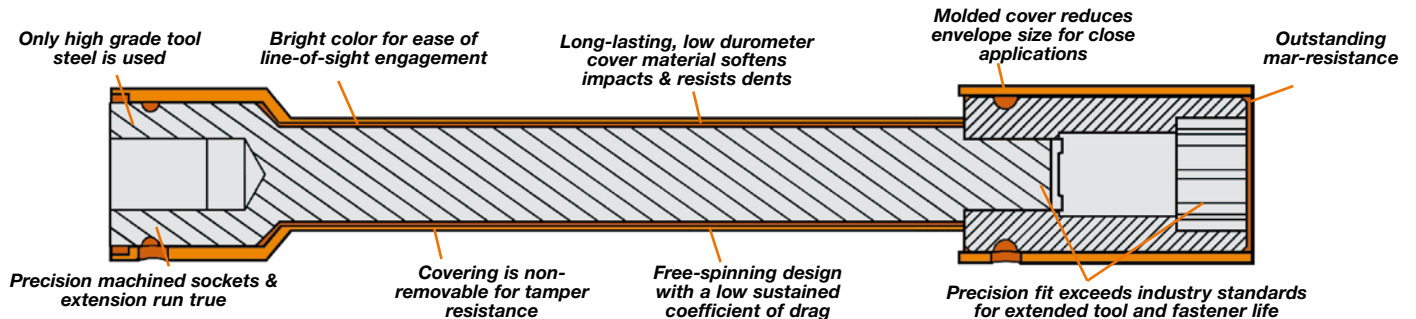

Quality Apex Tools Under The Cover

- Apex fastener tools are made from only tool grade steel then heat treated using our proprietary process for the proper hardness based on the application. Not too brittle to break nor too soft to wear out after one shift.
- Each core tool is then machined for a precision fit that exceeds industry standards. Improper fit can lead to premature fastener and fastener tool failure.
- Apex fastener tools run true with minimal wobble for more efficient fastening cycles.

The Cover Story

- A low durometer cover material that resists dents during incidental side impacts. Only Apex μ -Guard absorbs side impacts and does not produce raised burrs when impacted.
- Cover is molded to the tool for reduced envelope dimensions yet still is able to exhibit “free-spinning” capability for improved ergonomics and safety. No other competitor has this capability. Some competitors even require their core tool be modified in order to assemble the cover resulting in weaker integrity and premature failure.
- Covering is non-removable to prevent unwanted tampering on the line.
- Low sustained coefficient of friction between the cover and the tool yields minimal loss of tool efficiency.
- Bright color of covering makes fastener contact visually easier shift after shift and station monitoring quick and easy.
- Part numbers are clearly marked for ease of identification.
- Only Apex has the manufacturing capability, inventory and global supply network to supply the global requirements of today’s marketplace.

μ-Guard Sockets

(includes socket and Cover)



Part Number	Socket	Drive End			Socket Length	Fastener End			Assembly Features*	
		Size	Type	Sex		Size	Type	Sex		
UG-10MM21	10MM21	1/4	Square	F	standard	10 mm	Hex	F	FS	
UG-M-10MM21	M-10MM21	1/4	Square	F	standard	10 mm	Hex	F	FS, M	
UG-MB-10MM21	MB-10MM21	1/4	Square	F	standard	10 mm	Hex	F	FS, M, B	
UG-10MM13	10MM13	3/8	Square	F	standard	10 mm	Hex	F	FS	
UG-M-10MM13	M-10MM13	3/8	Square	F	standard	10 mm	Hex	F	FS, M	
UG-10MM23	10MM23	3/8	Square	F	long	10 mm	Hex	F	FS	
UG-M-10MM23	M-10MM23	3/8	Square	F	long	10 mm	Hex	F	FS, M	
UG-MB-10MM23	MB-10MM23	3/8	Square	F	long	10 mm	Hex	F	FS, M, B	
UG-13MM23	13MM23	3/8	Square	F	long	13 mm	Hex	F	FS	
UG-M-13MM23	M-13MM23	3/8	Square	F	long	13 mm	Hex	F	FS, M	
UG-MB-13MM23	MB-13MM23	3/8	Square	F	long	13 mm	Hex	F	FS, M, B	
UG-13MM25	13MM25	1/2	Square	F	long	13 mm	Hex	F	FS	
UG-SF-13MM25	SF-13MM25	1/2	Square	F	long	13 mm	Hex	F	FS, SF	
UG-15MM25	15MM25	1/2	Square	F	long	15 mm	Hex	F	FS	
UG-SF-15MM25	SF-15MM25	1/2	Square	F	long	15 mm	Hex	F	FS, SF	
UG-18MM25	18MM25	1/2	Square	F	long	18 mm	Hex	F	FS	
UG-SF-18MM25	SF-18MM25	1/2	Square	F	long	18 mm	Hex	F	FS, SF	

μ-Guard-Extensions

(includes extension and Cover)



Part Number	Extension	Drive End			Extension Length	Socket End			Assembly Features*	
		Size	Type	Sex		Size	Type	Sex		
UG-EX-250-2	EX-250-2	1/4	Hex	M	2	1/4	Square	M	FS	
UG-EX-250-4	EX-250-4	1/4	Hex	M	4	1/4	Square	M	FS	
UG-EX-250-6	EX-250-6	1/4	Hex	M	6	1/4	Square	M	FS	
UG-EX-370-2	EX-370-2	1/4	Hex	M	2	3/8	Square	M	FS	
UG-EX-370-4	EX-370-4	1/4	Hex	M	4	3/8	Square	M	FS	
UG-EX-370-6	EX-370-6	1/4	Hex	M	6	3/8	Square	M	FS	
UG-EX-376-3	EX-376-3	3/8	Square	F	3	3/8	Square	M	FS	
UG-EX-376-6	EX-376-6	3/8	Square	F	6	3/8	Square	M	FS	
UG-EX-376-12	EX-376-12	3/8	Square	F	12	3/8	Square	M	FS	
UG-EX-508-4	EX-508-4	1/2	Square	F	4	1/2	Square	M	FS	
UG-EX-508-8	EX-508-8	1/2	Square	F	8	1/2	Square	M	FS	
UG-EX-508-12	EX-508-12	1/2	Square	F	12	1/2	Square	M	FS	

μ-Guard-Bit Holders

(includes bit holder and Cover)



Part Number	Bit Holder	Drive End			Holder Extension	Fastener End			Assembly Features*	
		Size	Type	Sex		Size	Type	Sex		
UG-M-490	M-490	1/4	Hex	M	2 31/32	1/4	Hex	F	FS, M, ET	
UG-M-490-4	M-490-4	1/4	Hex	M	4	1/4	Hex	F	FS, M, ET	
UG-M-490-6	M-490-6	1/4	Hex	M	6	1/4	Hex	F	FS, M, ET	
UG-825	825	1/4	Square	F	1	1/4	Hex	F	FS, ET	
UG-M-825	M-825	1/4	Square	F	2 9/32	1/4	Hex	F	FS, M, ET	
UG-838	838	3/8	Square	F	1 1/2	1/4	Hex	F	FS, ET	
UG-M-838	M-838	3/8	Square	F	2 5/8	1/4	Hex	F	FS, M, ET	
UG-835	835	3/8	Square	F	1 1/2	5/16	Hex	F	FS, ET	
UG-M-835	M-835	3/8	Square	F	2 3/4	5/16	Hex	F	FS, M, ET	
UG-855	855	1/2	Square	F	1 1/2	5/16	Hex	F	FS, ET	
UG-M-855	M-855	1/2	Square	F	2 3/4	5/16	Hex	F	FS, M, ET	
UG-M-858	M-858	1/2	Square	F	2 3/4	1/4	Hex	F	FS, M, ET	

If your tool is not shown in the table of representative products above, please contact your Apex representative.

*Features Abbreviations

B Spring loaded magnet

SF Surface Drive

F Free Spinning

M Magnetic

ET Extended Tip

Tool is able to rotate independently of Cover
 Tool includes magnet to hold the position of the fastener during fastening operation
 Cover extends beyond end of Bit Holder to shield the majority of a standard Insert Bit.*

*Bit holder covers can be used with 1" or 1 1/4" long insert bits. Tip of cover can be modified by end user to suit application requirements or preference. Suggested methods of modifying covers include cutting to preferred length or heating up cover material and conforming to fastener head configuration.

Notes: Reported lengths are based on uncovered tool length only for reference. Cover may extend beyond end of tool by 2 mm unless otherwise noted.

Don't see what you need?

This catalog contains 3,000+ of the most frequently requested bits, sockets and fastening accessories. Our entire active offering approaches 10,000 sellable part numbers. If the tool you need does not appear in this catalog, give us a call. The odds are, we may have what you need as a non-catalog item. If not, our experienced staff of tooling experts can design and manufacture "specials" to meet the needs of your specific applications.

This flexibility has helped make Apex the only manufacturer which is a market and technology leader in all of the following industrial product categories: Bits & Bit Holders, Impact Sockets, Extensions and Universal Wrenches.

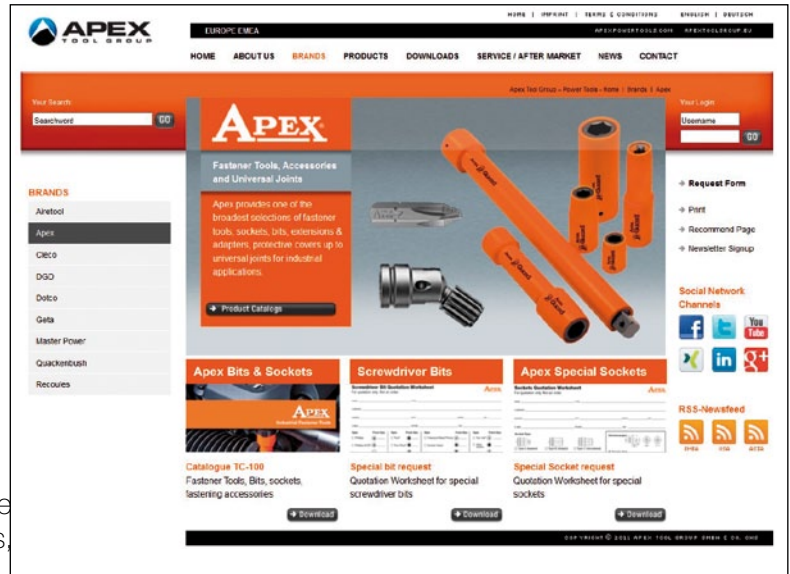

Get a quote on-line fast!

Easy to complete forms are available on-line at our website www.apex-tools.com.

You can even specify custom tooling on-line fast! Specification sheets for bits, sockets, extensions and universal joints are available on-line. Just complete the appropriate easy to use form and submit your request. You'll receive a rapid response from one of our experienced staff of tooling experts.

If the tool you need does not appear in this catalog, give us a call. The odds are, we may have what you need as a non-catalog item. If not, our experienced staff of tooling experts can design and manufacture "specials" to meet the needs of your specific applications.



Apex® has A Wide Selection Of Custom Designed Anti-Mar Covers.



Over Half A Century Of Quality In Every Design

For many years Apex has been producing protective covers for our quality products. Each was custom designed by our staff of engineers to work in a specific application. Over time we have developed a vast library of designs that work not only for their original applications but may also be a solution for one of your applications.

Our covered product designs include sockets, sockets and extensions, bits and bit holders, nutsetters and many more.

Each design was developed with one or more of the following unique features and capabilities:

- Free-spinning covers which allow the tool to rotate independently of the cover for improved protection of sensitive surfaces.
- Spring-loaded covers which retract when engaging the fastener.
- Embedded magnets in covers increase holding force on fastener.
- Single-piece construction to reduce material interfaces.
- Press fit/non-free-spinning for reduced envelope size in tight clearance applications.



Apex recognizes the need in assembly operations for the protection of painted or finished surfaces. We can coat just about any Apex bit or socket with a protective nylon sleeve. Shown above are some recently manufactured solutions with a brief description of the application.

1. Pickup-Truck Tailgate to Bed:

Torx®-T-45-Bit with magnets within the sleeve to secure fastener. WJ-1506-T50

2. Sun Visor Installation

Phillips bit used with magnetic bit holder. Nylon sleeve reduces headliner and visor damage. SD-5241-A

3. Lug Nut Assembly

Magnetic 19MM socket has nylon coating to protect chrome plated and polished aluminum wheels. HGSFNC-3028

4. Antenna Driver

Four-prong antenna bezel nutdriver with nylon sleeve to reduce damage to painted surface. BZCNC-30, -31

5. Spare Tire Wing Nut Assembly

All nylon socket to install low torque wing nut. WJ-1405

6. Painted Door Assembly

Only the nutsetter spins within the nylon sleeve, eliminating any mark on surface around the fastener. Nylon sleeve also protects adjacent painted door surface. MNC6N-08-10M-4

APEX® Solutions

Does Apex offer sockets for the installation of grease fittings?

Specially designed Apex sockets are the easy way to install or remove grease fittings.

(See page 81)



What's the real advantage of using socket adapters?

Socket adapters are an easy and economical solution for applications that require several different nut sizes.

(See page 83)



Does Apex offer tap holding sockets?

Apex offers a wide variety of tap holding adapters. These adapters allow you to easily convert your power tool into a tap drill.

(See page 80)

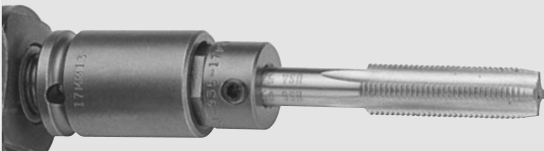

What's the advantage of a male hex drive socket?

A male hex drive socket lets you quickly accommodate a different nut size without pulling the primary socket off the power tool.

(See page 83)



Reversible Sockets for SAE Hex Head Sheet Metal Screws



Standard

Part Number	Hex Size	Overall Length	Outside Diameter	Roll Pin Part Number
SW-350	1/4	9/16	3/8	21-S-078-0375
SH-402	13/16	3/4	13/16	21-S-078-0750

Magnetic

Part Number	Hex Size	Overall Length	Outside Diameter	Spring Pin Part Number
MSW-350	1/4	31/32	3/8	21-S-078-0375
MSW-90	1/4	31/32	7/16	21-S-078-0437
MSW-90-B*	1/4	31/32	7/16	21-S-078-0437
MSW-984	5/16	31/32	9/16	21-S-078-0562
MSW-984-B*	5/16	31/32	9/16	21-S-078-0562
MSH-400	3/8	1 1/8	11/16	21-S-078-0687

*Tapered Ends

Shanks for Reversible Sockets



Part Number	Male Hex Power Drive	Male Hex Size	Overall Length	
SH-629	1/4	1/4	2	
SH-629-P	1/4	1/4	2	Pin Lock
SH-629-5	1/4	1/4	5	
SH-629-6	1/4	1/4	6	
SH-57	1/4	1/4	2	Full Length Hex
SH-57-3	1/4	1/4	3	Full Length Hex
SH-57-4	1/4	1/4	4	Full Length Hex
SH-57-6	1/4	1/4	6	Full Length Hex
SH-57-8	1/4	1/4	8	Full Length Hex
SH-59	1/4	5/16	2	
SH-59-3	1/4	5/16	3	
SH-59-4	1/4	5/16	4	
SH-59-6	1/4	5/16	6	
SH-412	1/4	3/8	2	
SH-414	1/4	1/2	2	
SH-404	7/16	3/8	2	

Valve Stem Drivers

1/4" Male Hex Drive

Part Number	Slot Size	Overall Length In.	Overall Length mm	Overall Diameter In.	Overall Diameter mm
SD-5197	0,09"	1,68	42,67	0,181	4,6
SD-5187	0,109"	2,5	63,50	0,176	4,5

Tap Holding Sockets

Male Hex Drive, SAE



(Tap not included)

Part Number	Tap Size	Male Hex	Socket Length In.	Socket Length mm	Socket Diameter In.	Socket Diameter mm
SJ-935-1/4	1/4	7/16	15/16	24	5/8	16
SJ-935-5/16	5/16	1/2	15/16	24	5/8	16
SJ-935-3/8 FS	3/8	9/16	1	25	21/32	17
SJ-935-7/16	7/16	5/8	1	25	3/4	19
SJ-935-1/2	1/2	3/4	1 1/4	32	7/8	22

Male Hex Drive, Metric



(Tap not included)

Part Number	Tap Size	Male Hex	Socket Length In.	Socket Length mm	Socket Diameter In.	Socket Diameter mm
SJ-935-10MMX6	M6	10	15/16	24	5/8	16
SJ-935-12MMX8	M8	12	15/16	24	5/8	16
SJ-935-14MMX10	M10	14	1	25	21/32	17
SJ-935-17MMX8	M8	17	1	25	13/16	21
SJ-935-17MMX12	M12	17	1	25	13/16	21

Female Square Drive, SAE



Part Number	Tap Size	Female Square	Socket Length In.	Socket Length mm	Socket Diameter In.	Socket Diameter mm
HC-100-10	#10	3/8	1 1/2	38	3/4	19
HC-100-1/4	1/4	3/8	1 1/2	38	3/4	19
HC-100-5/16	5/16	3/8	1 1/2	38	3/4	19
HC-100-3/8 FS	3/8	3/8	1 1/2	38	3/4	19
HC-100-7/16	7/16	3/8	1 1/2	38	3/4	19
HC-100-1/2	1/2	3/8	1 1/2	38	3/4	19
HC-100-5/8	5/8	3/8	1 3/4	46	1	25
HC-100-3/4	3/4	3/8	2	51	1	25
HE-100-1/4	1/4	1/2	1 1/2	38	7/8	22
HE-100-5/16	5/16	1/2	1 1/2	38	7/8	22
HE-100-3/8 FS	3/8	1/2	1 1/2	38	7/8	22
HE-100-7/16	7/16	1/2	1 1/2	38	7/8	22
HE-100-1/2	1/2	1/2	1 5/8	41	7/8	22
HE-100-5/8	5/8	1/2	1 3/4	46	1	25
HE-100-3/4	3/4	1/2	2	51	1	25

Ferry Cap® Sockets

3/8" Square Drive

Part Number	Head Size	Overall Length In.	Overall Length mm	Nose Diameter In.	Nose Diameter mm	Drive Diameter In.	Drive Diameter mm
FC-310	5/16"	1 1/4	31,75	15/32	11,9	5/8	15,9
FC-312	3/8"	1 1/4	31,75	9/16	4,3	3/4	19,0

Grease Fitting Sockets

For Angled Grease Fittings,
Deep and Shallow
Broach Depth



Part Number	6 Point	Magnetic	Hex Size	Square Drive	Overall Length		Broach Depth		Magnet Depth	
					In.	mm	In.	mm	In.	mm
ZN-112	-	-	3/8	1/4	1 1/4	32	9/16	14	-	-
ZN-312	MZN-312	-	3/8	3/8	1 1/2	38	9/16	14	7/32	6
ZN-512	-	-	3/8	1/2	1 1/2	32	9/16	14	-	-
ZN-114	-	-	7/16	1/4	1 1/4	32	7/16	11	-	-
ZN-314	MZN-314	-	7/16	3/8	1 1/2	38	7/16	11	7/16	11
ZN-514	MZN-514	-	7/16	1/2	1 1/2	38	7/16	11	7/16	11
ZE-112	-	-	3/8	1/4	1 1/4	32	1/8	3	-	-
ZE-314	-	-	7/16	3/8	1 1/2	38	3/16	5	-	-
ZE-514	-	-	7/16	1/2	1 1/2	38	3/16	5	-	-

For Straight
Grease Fittings



Part Number	6 Point	Magnetic	Hex Size	Square Drive	Overall Length		Broach Depth		Magnet Depth	
					In.	mm	In.	mm	In.	mm
ZA-110	MZA-110	-	5/16	1/4	1	25	1/8	3	21/64	8
ZA-310	MZA-310	-	5/16	3/8	1 1/4	32	1/8	3	21/64	8
ZA-510	MZA-510	-	5/16	1/2	1 1/2	38	1/8	3	19/64	7
ZA-512	-	-	3/8	1/2	1 1/2	38	1/8	3	-	-
ZA-314	MZA-314	-	7/16	3/8	1 1/4	32	3/16	5	23/64	9
ZA-514	MZA-514	-	7/16	1/2	1 1/2	38	3/16	5	3/8	10

Drill Holders

1/4" Male Hex Drive



Part Number	Drill Size	Overall Length		Body Diameter	
		In.	mm	In.	mm
WJ-284-7/64	7/64	2 5/8	67	1/2	13
WJ-284-1/8	1/8	2 5/8	67	5/8	16
WJ-284-9/64	9/64	2 5/8	67	5/8	16
WJ-284-5/32	5/32	2 5/8	67	3/4	19
WJ-284-3/16	3/16	2 5/8	67	3/4	19
WJ-284-1/4	1/4	2 5/8	67	3/4	19
WJ-284-5/16	5/16	2 5/8	67	3/4	19
WJ-284-3/8	3/8	2 5/8	67	1	25

7/16" Male Hex Drive



Part Number	Drill Size	Overall Length		Body Diameter	
		In.	mm	In.	mm
WJ-265-13/64	13/64	2 3/8	60	3/4	19
WJ-265-3/16	3/16	2 3/8	60	3/4	19
WJ-265-1/4	1/4	2 3/8	60	3/4	19
WJ-265-7/16	7/16	2 3/8	60	1	25
WJ-265-3/8	3/8	2 3/8	60	1	25
WJ-265-17/32	17/32	2 3/8	60	1 1/8	29
WJ-265-1/2	1/2	2 3/8	60	1 1/8	29

#5 (1 5/8") Spline Drive

Extensions



Part Number	Overall Length		Description
	In.	mm	
EXL-15	15	381	Female spline to male spline

Adapters



Part Number	Description
EXL-1000	Female spline to 1" male square
EXL-1100	Female spline to 1 1/2" male square

Universal Wrenches



Part Number	Description
MFL-250	Female spline to male spline (heavy duty)
MFL-1000	Female spline to 1" male square

*Universal wrenches must not be used with impact drivers.
Maximum operating angle is 30°.-*

#5 (1 5/8") Spline Drive Budd Wheel Sockets

Combo. 13/16" Square
1 1/2" Hex



Part Number	Drive	Overall Length	
		In.	mm
HT-848	#5 Spline	4 1/4	108

Socket Retaining Rings

Plastic Ring With Steel Insert



Part Number	Drive	Inside Diameter	
		In.	mm
10005S	3/4" Square	1 1/4	31,8
10032S	3/4" Square	1 7/16	36,5
10034S	3/4" Square	1 5/8	41,3
10008S	1" Square	1 3/4	44,5
10010S	1" Square	2	50,8
10015S	1" Square	2 1/8	54,0
10016S	1" Square	2 1/4	57,2
10017S	1" Square	2 1/2	63,5
10019S	1" Square	2 5/8	66,7
10020S	1 1/2" Square	2 7/8	73,0
10025S	1 1/2" Square	3 3/8	85,7

Metal Ring



Part Number	Drive	Inside Diameter	
		In.	mm
MET-1301C	3/8" Square	,677	17,2
MET-1302C	3/8" Square	,771	19,6
MET-1401C	1/2" Square	,885	22,5
MET-1402C	1/2" Square	1,086	27,6
MET-1600C	3/4" Square	1,594	40,5
MET-1800C	1" Square	1,948	49,5

Adapters

#130-A Yankee Drive for Spiral Type Driver



Part Number	Male Square In.	Overall Length		Shank Diameter	
		In.	mm	In.	mm
YK-250	1/4	1 15/16	49	,277	7,0
YK-370	3/8	2 3/16	56	,277	7,0
YK-500	1/2	2 5/16	59	,277	7,0

#131-A Yankee Drive for Spiral Type Driver



Part Number	Male Square In.	Overall Length		Shank Diameter	
		In.	mm	In.	mm
YK-501	1/2	2 5/16	59	,310	8,0

#135-A Yankee Drive for Spiral Type Driver



Part Number	Male Square In.	Overall Length		Shank Diameter	
		In.	mm	In.	mm
YK-252	1/4	1 15/16	49	,215	5,5
YK-37	3/8	2 3/16	56	,215	5,5
YK-502	1/2	2 5/16	59	,215	5,5

Female Threaded Adapters



Part Number	Female Thread	Male Square In.	Type of Lock
TH-257	3/8"-24	1/4	Pin
TH-377	3/8"-24	3/8	Pin
TH-501	3/8"-24	1/2	Pin
TH-378	1/2"-20	3/8	Pin
TH-502	1/2"-20	1/2	Pin

Male Threaded Adapters



Part Number	Male Thread	Hex Drive
TM-24	3/8"-24	1/4
TN-24	3/8"-24	7/16
TM-20	1/2"-20	1/4
TN-20	1/2"-20	7/16

Adapter

Socket & Ratchet Wrench Adapters, SAE



Part Number	Male Square In.	Male Hex In.	Overall Length In.
A-108	1/4	1/4	25/32
A-110	1/4	5/16	25/32
A-112	1/4	3/8	25/32
A-114	1/4	7/16	25/32
A-116	1/4	1/2	25/32
A-118	1/4	9/16	25/32
A-120	1/4	5/8	25/32
A-312	3/8	3/8	1 1/64
A-314	3/8	7/16	1 1/64
A-316	3/8	1/2	1 5/64
A-318	3/8	9/16	1 5/64
A-320	3/8	5/8	1 5/64
A-322	3/8	11/16	1 5/64
A-324	3/8	3/4	1 5/64
A-328	3/8	7/8	1 5/64
A-512	1/2	3/8	1 3/32
A-514	1/2	7/16	1 3/32
A-516	1/2	1/2	1 3/32
A-518	1/2	9/16	1 3/32
A-520	1/2	5/8	1 1/8
A-522	1/2	11/16	1 1/8
A-524	1/2	3/4	1 1/8
A-526	1/2	13/16	1 1/8
A-528	1/2	7/8	1 1/8
A-530	1/2	15/16	1 1/8
A-534	1/2	1 1/16	1 1/8
A-536	1/2	1 1/8	1 1/8
A-538	1/2	1 3/16	1 1/8
A-540	1/2	1 1/4	1 1/8

Socket & Ratchet Wrench Adapters, Metric



Part Number	Male Square In.	Male Hex mm	Overall Length In.	Overall Length mm
A-1-6MM	1/4	6	25/32	20
A-1-7MM	1/4	7	25/32	20
A-1-8MM	1/4	8	25/32	20
A-1-9MM	1/4	9	25/32	20
A-1-10MM	1/4	10	25/32	20
A-1-11MM	1/4	11	25/32	20
A-1-12MM	1/4	12	25/32	20
A-1-13MM	1/4	13	25/32	20
A-3-10MM	3/8	10	15/16	24
A-3-11MM	3/8	11	15/16	24
A-3-12MM	3/8	12	15/16	24
A-3-13MM	3/8	13	15/16	24
A-3-14MM	3/8	14	15/16	24
A-3-15MM	3/8	15	15/16	24
A-3-16MM	3/8	16	15/16	24
A-3-17MM	3/8	17	15/16	24
A-3-18MM	3/8	18	15/16	24
A-3-19MM	3/8	19	15/16	24
A-5-10MM	1/2	10	1 1/8	29
A-5-11MM	1/2	11	1 1/8	29
A-5-12MM	1/2	12	1 1/8	29
A-5-13MM	1/2	13	1 1/8	29
A-5-14MM	1/2	14	1 1/8	29
A-5-15MM	1/2	15	1 1/8	29
A-5-16MM	1/2	16	1 1/8	29
A-5-17MM	1/2	17	1 1/8	29
A-5-18MM	1/2	18	1 1/8	29
A-5-19MM	1/2	19	1 1/8	29
A-5-20MM	1/2	20	1 1/8	29
A-5-21MM	1/2	21	1 1/8	29
A-5-22MM	1/2	22	1 1/8	29
A-5-23MM	1/2	23	1 1/8	29
A-5-24MM	1/2	24	1 1/8	29
A-5-25MM	1/2	25	1 1/8	29

Sockets with Male Hex



Part Number	Female Square In.	Male Hex In.	Overall Length In.	Overall Length mm
SJ-375	5/16	3/8	13/16	21
SJ-379	1/2	3/8	1	25
SJ-380	9/16	3/8	1	25
SJ-349	3/8	7/16	15/16	24
SJ-350	7/16	7/16	15/16	24
SJ-351	1/2	7/16	1	25
SJ-352	9/16	7/16	1	25
SJ-360	3/8	1/2	15/16	24
SJ-361	7/16	1/2	15/16	24
SJ-241	1/2	1/2	1	25
SJ-362	9/16	1/2	1	25
SJ-364	11/16	1/2	1 3/16	30
SJ-55	7/16	9/16	15/16	24
SJ-66	1/2	9/16	1	25
SJ-67	9/16	9/16	1	25
SJ-68	5/8	9/16	1 1/8	28

Hex Drive Universal Adapters



Male Hex to Male Square – Extension

Part Number Standard	Part Number Tension	Male Square In.	Male Hex In.	Type of Lock	Overall Length In.	Overall Length mm	Largest Diameter In.	Largest Diameter mm
-	KSM-25-3	1/4	1/4	Pin	3	76	5/8	15,9
KCM-25-B-6	KSM-25-B-6	1/4	1/4	Ball	6	152	5/8	15,9
KCM-37-6	KSM-37-6	3/8	1/4	Pin	6	152	3/4	19,1
-	KSM-37-B-6	3/8	1/4	Ball	6	152	3/4	19,1

Universal wrenches must not be used with impact drivers.

Maximum operating angle is 30°.-

Standard lengths are 3", 6", 9" and 12" (76, 152, 229 and 305mm).

Screwdriver Bit Quotation Worksheet



For quotation only. Not an order.

NAME _____ TITEL _____

COMPANY _____

ADDRESS _____ CITY _____ STATE _____ ZIP _____

E-MAIL _____ PHONE _____ FAX _____

Style	Point-Size	Style	Point-Size	Style	Point-Size	Style	Point-Size
<input type="checkbox"/> Phillips	_____	<input type="checkbox"/> Torx®	_____	<input type="checkbox"/> Frearson/Reed Prince	_____	<input type="checkbox"/> Torx-Set®	_____
<input type="checkbox"/> Phillips ACR®	_____	<input type="checkbox"/> Torx Plus®	_____	<input type="checkbox"/> Socket Head	_____	<input type="checkbox"/> Triple Square	_____
<input type="checkbox"/> Slotted	_____	<input type="checkbox"/> Pozidriv®	_____	<input type="checkbox"/> Square	_____	<input type="checkbox"/> Tri-Wing	_____
						<input type="checkbox"/> Other	_____

Drive Type	Size
<input type="checkbox"/> Hex Insert	_____
<input type="checkbox"/> Hex Power	_____
<input type="checkbox"/> Threaded	_____
<input type="checkbox"/> Female Square	_____
<input type="checkbox"/> Other	_____

Nylon Covers Requirements

Components To Be Covered	Cover Features
<input type="checkbox"/> Bit only	<input type="checkbox"/> Flush with tip of bit
<input type="checkbox"/> Bit and Bit Holder	<input type="checkbox"/> Exposed tip of bit
	<input type="checkbox"/> Retractable
	<input type="checkbox"/> Embedded magnets
	<input type="checkbox"/> Press fit
	<input type="checkbox"/> Free-spinning (able to spin independently of part being covered)
	<input type="checkbox"/> O.D. limitations (must specify) _____
	<input type="checkbox"/> Other considerations (must specify) _____

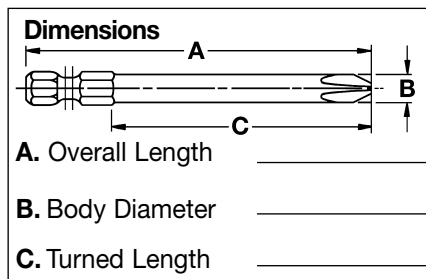

Bit holder drives for insert bits

<input type="checkbox"/> Magnetic	Bit Holder Drive Types	Size
<input type="checkbox"/> O-Ring Retention	<input type="checkbox"/> Hex Drive	_____
<input type="checkbox"/> Standard (Retaining Groove)	<input type="checkbox"/> Female Square	_____
<input type="checkbox"/> Quick Release	<input type="checkbox"/> Other	_____
<input type="checkbox"/> Other _____		

Quantity _____

Applied or Driving Torque _____

Additional _____

Sockets Quotation Worksheet

For quotation only. Not an order.



NAME _____ TITEL _____

COMPANY _____





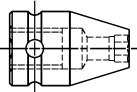
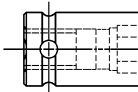
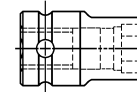

ADDRESS _____ CITY _____ STATE _____ ZIP _____

E-MAIL _____ PHONE _____ FAX _____

Socket Type

- Type A (tapered) 
 Type B (straight) 
 Type C (shouldered) 

Broach Opening

- Hex 
 Double Square 
 Torx® 
- Double Hex 
 Fast Lead 
 Other
- Square 
 Surface Drive 

Magnetic

- Magnetic Bolt Clearance (MB)
 Magnetic Bolt Clearance with retaining ring (RMB)
 Strip Magnet (SM)
 Fixed Magnet (M)
 Non-magnetic

Drive Configuration

- DIN Standard
 No DIN groove
 Cross Hole (one wall only)

Extensions

- Hex Drive _____
 Female Square _____
 Other _____

Size

Extension Length

- No extension required

Nylon Covers Requirements

Components To Be Covered

- Bit only
 Bit and Bit Holder

Cover Features

- Flush with tip of bit
 Exposed tip of bit
 Retractable
 Embedded magnets
 Press fit
 Free-spinning (able to spin independently of part being covered)
 O.D. limitations (must specify) _____
 Other considerations (must specify) _____

Abmessungen

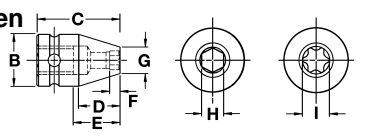

A. Square drive _____
B. Drive end diameter _____
C. Overall Length _____
D. Taper or shoulder length _____
E. Bolt clearance depth _____
F. Broach depth _____
G. Nose end diameter _____
H. Broach opening _____
I. Torx® size  _____

Quantity _____

Additional _____

Applied or Driving Torque _____

Universal Wrench Quotation Worksheet



For quotation only. Not an order.

NAME _____ TITEL _____

COMPANY _____

ADDRESS _____ CITY _____ STATE _____ ZIP _____

E-MAIL _____ PHONE _____ FAX _____

Dimensions

Female square drive, standard Type

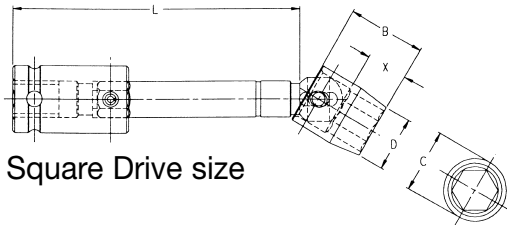

Square Drive size _____

Female square drive, tension Type

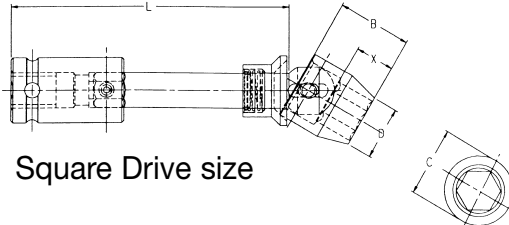

Square Drive size _____

Male hex drive, standard Type

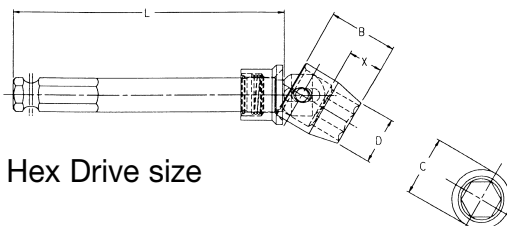

Hex Drive size _____

Male hex drive, tension Type

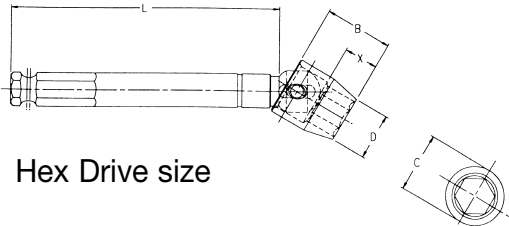

Hex Drive size _____

Female square drive, (short)

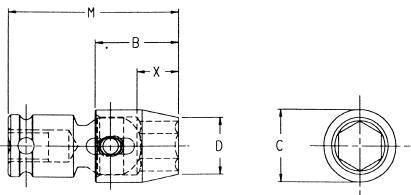

Square Drive size _____

B. Socket length _____ C. Socket diameter* _____

D. Socket nose dia. _____ G. Depth of Clearance _____

L. Shank length _____ M. Overall Length _____

*Standard diameters are: 5/8", 3/4", 7/8", 1", 1 1/4", 1 1/2", 1 3/4", 2"

* Universal wrenches are not recommended for impact applications. Maximum operating angle 30°.

Broach Opening Style & Size

Hex _____ Double Hex _____ **Quantity** _____

Male Square
 { Pin lock
 Ball lock
 Hole _____ **Applied or Driving Torque** _____

Additional Specifications _____

Part Number Index

Number	Page	Number	Page	Number	Page	Number	Page	Number	Page	Number	Page	Number	Page	Number	Page
152	71	3010	46	3512	46	5316	55	5820	58	7356	68	8384	71	10MM21	43
160	42	3012	46	3514	46	5318	55	5822	58	7358	68	8432	71	10MM21	76
360	48	3014	46	3516	46	5320	55	5912	58	7360	68	8434	71	10MM21-D	43
450	31	3016	46	3518	46	5322	55	5914	58	7362	68	8436	71	10MM23	50
460	31	3018	46	3524	46	5324	55	5918	58	7364	68	8440	71	10MM23	76
480	31	3020	46	3530	46	5326	55	5920	58	7372	68	8442	71	10MM23-D	50
488	31	3022	46	3532	46	5328	55	6118	66	7424	68	8448	71	10MM25	60
490	31	3024	46	3534	46	5330	55	6120	66	7426	68	8454	71	10MM33	50
630	31	3028	46	3607	48	5332	55	6122	66	7428	68	8456	71	10MM35	60
638	31	3108	46	3609	48	5334	55	6124	66	7430	68	8458	71	10MM43	50
820	33	3109	46	3610	48	5336	55	6128	66	7432	68	8460	71	10MM43-D	50
821	9	3110	46	3612	48	5338	55	6134	66	7434	68	8464	71	10MM45	60
822	9	3111	46	3614	48	5340	55	6136	66	7436	68	8472	71	10MM55	61
825	33	3112	46	3616	48	5342	55	6140	66	7438	68	8480	71	10MM55-D	61
825	76	3113	46	3618	48	5344	55	6142	66	7442	68	8530	71	10MME1	44
830	33	3114	46	3620	48	5348	55	6144	66	7446	68	8536	71	10MME3	51
832	9	3116	46	3624	48	5412	55	6146	66	7448	68	8540	71	1106-D	41
833	9	3117	46	5108	55	5414	55	6148	66	7454	68	8542	71	1107-D	41
834	9	3118	46	5110	55	5416	55	6320	66	7456	68	8624	72	1108-D	41
835	33	3119	46	5112	55	5418	55	6322	66	7524	68	8632	72	1109-D	41
835	76	3120	46	5114	55	5420	55	6324	66	7528	68	8634	72	1110-D	41
838	33	3122	46	5116	55	5421	55	6326	66	7530	68	8636	72	1111-D	41
838	76	3124	46	5118	55	5422	55	6330	66	7536	68	8638	72	1112-D	41
850	33	3126	46	5119	55	5424	55	6336	66	7540	68	8640	72	1114-D	41
852	9	3208	46	5120	55	5426	55	6340	66	7542	68	8644	72	1116-D	41
853	9	3209	46	5122	55	5428	55	6342	66	7548	68	8648	72	11MM03	50
854	9	3210	46	5124	55	5430	55	6344	66	7552	68	9172	73	11MM03-D	50
855	33	3211	46	5126	55	5432	55	6348	66	7556	68	1E08	42	11MM11	43
855	76	3212	46	5128	55	5434	55	6426	66	7624	69	1E10	42	11MM11-D	43
858	33	3214	46	5130	55	5436	55	6430	66	7628	69	3E10	48	11MM13	50
1105	41	3216	46	5131	55	5438	55	6524	66	7630	69	5E10	57	11MM13-D	50
1106	41	3218	46	5132	55	5440	55	7120	68	7632	69	3E11	48	11MM15	60
1107	41	3220	46	5134	55	5442	55	7122	68	7636	69	3E12	48	11MM15-D	60
1108	41	3222	46	5136	55	5510	56	7124	68	8126	71	5E12	57	11MM21	43
1109	41	3224	46	5138	55	5512	56	7128	68	8138	71	3E14	48	11MM23	50
1110	41	3226	46	5140	55	5514	56	7130	68	8142	71	3E16	48	11MM23-D	50
1111	41	3228	46	5142	55	5516	56	7132	68	8148	71	5E16	57	11MM25	60
1112	41	3308	46	5144	55	5518	56	7134	68	8160	71	10005S	82	11MM35	60
01112	73	3310	46	5146	55	5520	56	7136	68	8162	71	10008S	82	11MM43	50
1113	41	3311	46	5148	55	5522	56	7140	68	8170	71	10010S	82	11MM55	61
1114	41	3312	46	5152	55	5524	56	7142	68	8172	71	10015S	82	11MME1	44
1116	41	3314	46	5154	55	5526	56	7144	68	8174	71	10016S	82	1206-D	41
1118	41	3316	46	5156	55	5528	56	7146	68	8176	71	10017S	82	1208-D	41
1120	41	3318	46	5210	55	5530	56	7148	68	8180	71	10019S	82	1209-D	41
1206	41	3320	46	5212	55	5532	56	7152	68	8186	71	10020S	82	1210-D	41
1207	41	3322	46	5214	55	5534	56	7154	68	8188	71	10025S	82	1212-D	41
1208	41	3324	46	5216	55	5609	58	7156	68	8190	71	10032S	82	1216-D	41
1209	41	3326	46	5218	55	5610	58	7158	68	8228	71	10034S	82	12MM03	50
1210	41	3328	46	5220	55	5612	58	7160	68	8236	71	103-00X	14	12MM03-D	50
1211	41	3408	46	5222	55	5614	58	7164	68	8240	71	103-1X	14	12MM11	43
1212	41	3409	46	5224	55	5616	58	7168	68	8324	71	103-2X	14	12MM11-D	43
1213	41	3410	46	5226	55	5618	58	7170	68	8326	71	103-3X	14	12MM13	50
1214	41	3412	46	5228	55	5620	58	7172	68	8332	71	103-4X	14	12MM13-D	50
1216	41	3414	46	5230	55	5622	58	7176	68	8336	71	103-5X	14	12MM15	60
1218	41	3416	46	5232	55	5624	58	7180	68	8338	71	103-6X	14	12MM15-D	60
1308	41	3418	46	5234	55	5626	58	7328	68	8340	71	10F-12R	34	12MM21	43
1310	41	3420	46	5236	55	5628	58	7330	68	8342	71	10MM03	50	12MM23	50
1311	41	3424	46	5238	55	5632	58	7332	68	8346	71	10MM03-D	50	12MM23-D	50
1312	41	3426	46	5240	55	5634	58	7334	68	8356	71	10MM11	43	12MM25	60
1313	41	3428	46	5242	55	5636	58	7336	68	8360	71	10MM11-D	43	12MM35	60
1314	41	3430	46	5244	55	5716	58	7340	68	8364	71	10MM13	50	12MM43	50
1316	41	3432	46	5248	55	5720	58	7342	68	8370	71	10MM13-D	76	12MM43-D	50
1318	41	3434	46	5310	55	5724	58	7346	68	8378	71	10MM13-D	50	12MM45	60
1320	41	3510	46	5312	55	5728	58	7348	68	8380	71	10MM15	60	12MM55	61
1612	42	3511	46	5314	55	5812	58	7352	68	8382	71	10MM15-D	60	12MM55-D	61

Part Number Index

Number	Page	Number	Page	Number	Page	Number	Page	Number	Page	Number	Page	Number	Page	Number	Page
12MME1	44	15MM45	60	17MM35	60	1P07	42	22MM25	60	273-6	28	30MM48	72	324-5X	13
1308-D	41	15MM55	61	17MM36	67	1P08	42	22MM35	60	273-8	28	30MM55	61	324-6X	13
1311-D	41	15MM55-D	61	17MM43	50	1P10	42	22MM45	60	273A-1	28	30MM57	70	325-000X	13
13MM03	50	15MME5	62	17MM43-D	50	1P11	42	22MM47	70	273A-10	28	3108-D	46	325-00X	13
13MM03-D	50	1608-D	42	17MM45	60	1P12	42	22MM55	61	273A-2	28	3110-D	46	325-0X	13
13MM11	43	1612-D	42	17MM55	61	1P14	42	22MM55-D	61	273A-3	28	3112-D	46	325-1X	13
13MM11-D	43	16MM03	50	17MM55-D	61	1P16	42	22MM57	70	273A-4	28	3113-D	46	325-20X	13
13MM13	50	16MM03-D	50	185-000X	23	20MM03	50	23MM15	60	273A-6	28	3114-D	46	325-3X	13
13MM13-D	50	16MM11	43	185-00X	23	20MM15	60	23MM15-D	60	273A-8	28	3116-D	46	325-4X	13
13MM15	60	16MM13	50	185-0X	23	20MM17	70	23MM25	60	273B-0	28	3120-D	46	325-5X	13
13MM15-D	60	16MM13-D	50	185-1.5MM	23	20MM25	60	24 Bit Kit	34	273B-1	28	3124-D	46	325-6X	13
13MM21	43	16MM15	60	185-10MM	23	20MM35	60	24MM15	60	273B-10	28	315-10MM	23	326-000X	13
13MM21-D	43	16MM15-D	60	185-10X	23	212-0	27	24MM15-D	60	273B-2	28	315-12MM	23	326-00X	13
13MM23	50	16MM16	67	185-1X	23	212-1	27	24MM16	67	273B-3	28	315-14MM	23	326-0X	13
13MM23	76	16MM21	43	185-2.5MM	23	212-1/4	27	24MM17	70	273B-4	28	315-2.5MM	23	326-1X	13
13MM23-D	50	16MM23	50	185-2MM	23	212-1/4A	27	24MM18	70	273B-5	28	315-3X	23	326-20X	13
13MM25	60	16MM23-D	50	185-2X	23	212-1/4A-ACR	27	24MM25	60	273B-6	28	315-4MM	23	326-2X	13
13MM25	76	16MM25	60	185-3MM	23	212-1/4-ACR	27	24MM35	60	273B-8	28	315-4X	23	326-3X	13
13MM33	50	16MM35	60	185-3X	23	212-10	27	24MM36	67	27MM15	60	315-5MM	23	326-4X	13
13MM35	60	16MM43	50	185-4-4X	23	212-10A	27	24MM37	70	27MM15-D	60	315-5X	23	326-5X	13
13MM43	50	16MM43-D	50	185-4MM	23	212-10-ACR	27	24MM38	72	27MM17	70	315-6MM	23	326-6X	13
13MM43-D	50	16MM45	60	185-4X	23	212-2	27	24MM47	70	27MM18	72	315-6X	23	327-000X	13
13MM45	60	16MM55	61	185-5MM	23	212-3	27	24MM55	61	27MM25	60	315-7MM	23	327-00X	13
13MM55	61	16MM55-D	61	185-5X	23	212-3/8A	27	24MM55-D	61	27MM37	70	315-7X	23	327-0X	13
13MM55-D	61	170-0	28	185-6MM	23	212-4	27	24MM57	70	27MM38	72	315-8MM	23	327-1X	13
13MME1	44	170-1	28	185-6X	23	212-5	27	25MM15	60	27MM47	70	315-8X	23	327-20X	13
13MME3	51	170-1/2	28	185-7MM	23	212-5/16A	27	25MM25	60	27MM55	61	320-000X	13	327-2X	13
14MM03	50	170-1/4	28	185-7X	23	212-5/16A-ACR	27	25MM35	60	27MM55-D	61	320-00X	13	327-3X	13
14MM03-D	50	170-1/4A	28	185-8MM	23	212-6	27	25MM37	70	27MM57	70	320-0X	13	327-4X	13
14MM11	43	170-1/4-ACR	28	185-8X	23	212-6-ACR	27	265-0	28	28MM15	60	320-1X	13	327-5X	13
14MM11-D	43	170-1/4B	28	185-9MM	23	212-8	27	265-1	28	28MM25	60	320-20X	13	327-6X	13
14MM13	50	170-10	28	185-9X	23	212-8A	27	265-1/4	28	28MM37	70	320-2X	13	328-000X	13
14MM13-D	50	170-10A	28	18MM03	50	212-8-ACR	27	265-10	28	28MM38	72	320-3X	13	328-00X	13
14MM15	60	170-10-ACR	28	18MM13	50	21MM03	50	265-2	28	29MM15	60	320-4X	13	328-0X	13
14MM15-D	60	170-2	28	18MM13-D	50	21MM13	50	265-3	28	29MM15-D	60	320-5X	13	328-1X	13
14MM21	43	170-3	28	18MM15	60	21MM15	60	265-4	28	29MM17	70	320-6X	13	328-20X	13
14MM23	50	170-3/8	28	18MM15-D	60	21MM15-D	60	265-5	28	29MM18	72	3208-D	46	328-2X	13
14MM23-D	50	170-3/8A	28	18MM16	67	21MM16	67	265-5/16	28	29MM37	70	3210-D	46	328-3X	13
14MM25	60	170-3/8B	28	18MM17	70	21MM17	70	265-6	28	29MM55	61	3212-D	46	328-4X	13
14MM35	60	170-3/8C	28	18MM23	50	21MM18	72	265-8	28	3,5MM11	43	3214-D	46	328-5X	13
14MM43	50	170-4	28	18MM23-D	50	21MM23	50	265A-0	28	3,5MME1	44	3216-D	46	328-6X	13
14MM43-D	50	170-5	28	18MM25	60	21MM25	60	265A-1	28	3012-D	46	3218-D	46	32MM15	60
14MM45	60	170-5/16	28	18MM25	76	21MM35	60	265A-1/4	28	3014-D	46	3220-D	46	32MM15-D	60
14MM55	61	170-5/16A	28	18MM35	60	21MM36	67	265A-10	28	3016-D	46	3222-D	46	32MM17	70
14MM55-D	61	170-5/16-ACR	28	18MM43	50	21MM37	70	265A-2	28	3018-D	46	3224-D	46	32MM18	72
1500-P	34	170-5/16B	28	18MM45	60	21MM45	60	265A-3	28	3020-D	46	3226-D	46	32MM25	60
1510-P	34	170-5/8	28	18MM55	61	21MM55	61	265A-3/8	28	3022-D	46	3228-D	46	32MM37	70
15MM03	50	170-6	28	18MM55-D	61	21MM55-D	61	265A-4	28	3024-D	46	323-000X	13	32MM47	70
15MM03-D	50	170-6-ACR	28	19MM03	50	21MM57	70	265A-5	28	3028-D	46	323-00X	13	32MM55	61
15MM11	43	170-7/1	28	19MM03-D	50	21-S-156-0375	33	265A-5/16	28	309-000X	14	323-0X	13	3310-D	46
15MM13	50	170-7/16C	28	19MM13	50	21-S-156-0750	33	265A-6	28	309-00X	14	323-1X	13	3312-D	46
15MM13-D	50	170-8	28	19MM13-D	50	21-S-156-0937	33	265A-7/16	28	309-1X	14	323-20X	13	3314-D	46
15MM15	60	170-8A	28	19MM15	60	21-S-187-1125	33	265A-8	28	309-2X	14	323-2X	13	3316-D	46
15MM15-D	60	170-8-ACR	28	19MM15-D	60	21-S-187-1250	33	26MM15	60	309-3X	14	323-3X	13	3318-D	46
15MM21	43	170-9/16	28	19MM17	70	21-S-187-1375	33	26MM15-D	60	309-4X	14	323-4X	13	3320-D	46
15MM21-D	43	17MM03	50	19MM23	50	21-S-187-1500	33	26MM17	70	309-5X	14	323-5X	13	3324-D	46
15MM23	50	17MM13	50	19MM23-D	50	21-S-187-1500	33	26MM25	60	309-6X	14	323-6X	13	3326-D	46
15MM23-D	50	17MM13-D	50	19MM25	60	21-S-187-1625	33	26MM55	61	309-8X	14	324-000X	13	33MM15	60
15MM25	60	17MM15	60	19MM35	60	21-S-187-1625	33	273-0	28	30MM15	60	324-00X	13	33MM17	70
15MM25	76	17MM15-D	60	19MM36	67	22MM03	50	273-1	28	30MM15-D	60	324-0X	13	33MM37	70
15MM33	50	17MM16	67	19MM43	50	22MM13	50	273-10	28	30MM17	70	324-1X	13	33MM38	72
15MM33-D	50	17MM17	70	19MM43-D	50	22MM15	60	273-2	28	30MM18	72	324-20X	13	3408-D	46
15MM35	60	17MM23	50	19MM45	60	22MM15-D	60	273-3	28	30MM25	60	324-2X	13	3410-D	46
15MM43	50	17MM23-D	50	19MM55	61	22MM17	70	273-4	28	30MM37	70	324-3X	13	3412-D	46
15MM43-D	50	17MM25	60	1P06	42	22MM23	50	273-5	28	30MM47	70	324-4X	13	3414-D	46

Part Number Index

Number	Page	Number	Page	Number	Page	Number	Page	Number	Page	Number	Page	Number	Page	Number	Page
3416-D	46	440-225-SFX	20	440-TX-06X	16	446-FX	21	48-TSQ-5M	27	492-B-PZDX	19	49-B-27IPX	19	502-AX	9
3418-D	46	440-225X	7	440-TX-07-H	16	451X	8	48-TSQ-6M	27	492-B-SFX	20	49-B-30IPX	19	502-PZDX	19
3420-D	46	440-22-ACR2-DX	7	440-TX-07X	16	452X	8	48-TSQ-8M	27	492-BX	8	49-B-TX-05	17	502X	9
3424-D	46	440-22-ACR2-DX	7	440-TX-08-H	16	453X	8	48-TX-40	17	492-C-27X	8	49-B-TX-07	17	503X	9
3430-D	46	440-22-ACR2-RX	7	440-TX-08X	16	46MM17	70	48-TX-45	17	492-C-ACR2-DX	8	49-B-TX-08	17	50MM18	72
34MM15	60	440-22-ACR2-RX	7	440-TX-09-H	16	46MM18	72	48-TX-50	17	492-CC-27X	8	49-B-TX-09	17	50MM38	72
34MM18	72	440-22-ACR2X	7	440-TX-09X	16	46MM38	72	48-TX-55	17	492-CCX	8	49-B-TX-10	17	50-TX-08	18
34MM37	70	440-22-ACR2X	7	440-TX-10-H	16	480-1-PZDX	19	490-10	31	492-CFX	21	49-B-TX-15	17	50-TX-10	18
3512-D	46	440-22-PZDX	19	440-TX-10X	16	480-1X	7	490-3	31	492-CI	8	49-B-TX-15-H	17	50-TX-15	18
3514-D	46	440-22-SFX	20	440-TX-15-125	16	480-225X	7	490-4	31	492-C-PZDX	19	49-B-TX-15-W	17	50-TX-20	18
3516-D	46	440-22X	7	440-TX-15-H	16	480-22X	7	490-5	31	492-C-SFX	20	49-B-TX-20	17	510-D	55
3518-D	46	440-23X	7	440-TX-15X	16	480-24X	7	490-6	31	492-CX	8	49-B-TX-20-H	17	5112-D	55
3524-D	46	440-24X	7	440-TX-20-125	16	480-2-ACR2-RX	7	490-8	31	492-FX	21	49-B-TX-20-W	17	5114-D	55
35MM15	60	440-255X	7	440-TX-20-2	16	480-2-ACR2X	7	4910-AX	8	492I	8	49-B-TX-25	17	5116-D	55
3609-D	48	440-25IPRX	18	440-TX-20-H	16	480-2-PZDX	19	4910-BX	8	492-PZDX	19	49-B-TX-27	17	5118-D	55
3610-D	48	440-25IPX	18	440-TX-20X	16	480-2-SFX	20	4910-CX	8	492-SFX	20	49-B-TX-30	17	5120-D	55
3612-D	48	440-26X	7	440-TX-25-H	16	480-2X	7	49-10IPRX	19	492X	8	49-B-TX-30-W	17	5122-D	55
3614-D	48	440-27IPRX	18	440-TX-25X	16	480-30IPX	18	49-10IPX	19	4930-AX	8	49-B-TX-40	17	5124-D	55
3616-D	48	440-27IPX	18	440-TX-27-H	16	480-325X	7	4910X	8	4930-BX	8	49-C-TX-07	17	5126-D	55
3618-D	48	440-27X	7	440-TX-27X	16	480-34X	7	49-15IPRX	19	4930-CCX	8	49-C-TX-08	17	5128-D	55
36MM15	60	440-2-ACR2-DX	7	440-TX-30-H	16	480-3-ACR3X	7	49-15IPX	19	4930-CX	8	49-C-TX-09	17	5130-D	55
36MM17	70	440-2-ACR2-DX	7	440-TX-30X	16	480-3-PZDX	19	491-ACR1-DX	8	49-30IPRX	19	49-C-TX-10	17	5132-D	55
36MM18	72	440-2-ACR2-RI	7	440-TX-40-H	16	480-3X	7	491-ACR1-RX	8	49-30IPX	19	49-C-TX-15	17	5134-D	55
36MM37	70	440-2-ACR2-RI	7	440-TX-40I	16	480-40IPX	18	491-ACR1X	8	4930X	8	49-C-TX-20	17	5136-D	55
36MM38	72	440-2-ACR2-RX	7	440-TX-40X	16	480-425X	7	491-AFX	21	493-ACR3X	8	49-C-TX-20-H	17	5138-D	55
37MM17	70	440-2-ACR2-RX	7	440-TX-45X	16	480-45IPX	18	491-A-PZDX	19	493-A-PZDX	19	49-C-TX-25	17	5140-D	55
37MM38	72	440-2-ACR2X	7	440-TX-50X	16	480-4-ACR4X	7	491-A-SFX	20	493-AX	8	49-C-TX-27	17	5144-D	55
3P10	48	440-2-ACR2X	7	445-000X	13	480-4BNX	7	491-AX	8	493-BFX	21	49-C-TX-30	17	5148-D	55
3P12	48	440-21	7	445-00-15X	13	480-4X	7	491-BFX	21	493-B-PZDX	19	49-C-TX-40	17	5152-D	55
3P14	48	440-2-PZDX	19	445-00X	13	480-50IPX	18	491-B-PZDX	19	493-BX	8	49-TSQ-10M	27	5216-D	55
3P16	48	440-2-SFX	20	445-0-15X	13	480-55IPX	18	491-B-SFX	20	493-C-PZDX	19	49-TSQ-12M	27	5218-D	55
4,5MM11	43	440-2X	7	445-0X	13	480-FX	21	491-BX	8	493-CX	8	49-TSQ-4M	27	5224-D	55
400-BH	31	440-30IPRX	18	445-10-15X	13	480-MT-3	28	491-CCX	8	493-FX	21	49-TSQ-5M	27	5226-D	55
401-PZDX	19	440-30IPX	18	445-10X	13	480-TSQ-10M	27	491-CFX	21	493-PZDX	19	49-TSQ-6M	27	5228-D	55
401X	9	440-3125X	7	445-15X	13	480-TSQ-12M	27	491-C-PZDX	19	493X	8	49-TSQ-8M	27	5230-D	55
402-PZDX	19	440-325X	7	445-1X	13	480-TSQ-14M	27	491-C-SFX	20	49-40IPRX	19	49-TX-05	17	5236-D	55
402X	9	440-32X	7	445-20-15X	13	480-TSQ-6M	27	491-CX	8	49-40IPX	19	49-TX-06	17	5240-D	55
403-PZDX	19	440-33X	7	445-20X	13	480-TSQ-8M	27	491-FX	21	494X	8	49-TX-07	17	5316-D	55
403X	9	440-34X	7	445-2-15X	13	480-TX-20X	16	491-PZDX	19	498 2 3/8 60	31	49-TX-08	17	5318-D	55
41MM17	70	440-3-ACR3-DX	7	445-2X	13	480-TX-25X	16	491-SFX	20	49-A-10IPX	19	49-TX-08-W	17	5322-D	55
41MM18	72	440-3-ACR3-DX	7	445-30-15X	13	480-TX-27X	16	491X	8	49-A-15IPX	19	49-TX-09	17	5324-D	55
41MM37	70	440-3-ACR3-RX	7	445-30X	13	480-TX-30X	16	49-20IPRX	19	49-A-20IPX	19	49-TX-10	17	5330-D	55
42MM18	72	440-3-ACR3-RX	7	445-3-15X	13	480-TX-40-4X	16	49-20IPX	19	49-A-25IPX	19	49-TX-10-H T-10-H	17	5336-D	55
440-10IPRX	18	440-3-ACR3X	7	445-3X	13	480-TX-40-H	16	492-200MM	8	49-A-27IPX	19	49-TX-10-W	17	5340-D	55
440-10IPX	18	440-3-ACR3X	7	445-4-15X	13	480-TX-40X	16	492-27X	8	49-A-30IPX	19	49-TX-15	17	5412-D	55
440-115X	7	440-3BNX	7	445-4X	13	480-TX-45-6	16	49-25IPRX	19	49-A-TX-05	17	49-TX-15-H T-15-H	17	5414-D	55
440-125X	7	440-3I	7	445-5X	13	480-TX-45-H	16	49-25IPX	19	49-A-TX-06	17	49-TX-15-W	17	5416-D	55
440-12X	7	440-3-PZDX	19	445-6X	13	480-TX-45X	16	49-27IPRX	19	49-A-TX-07	17	49-TX-20	17	5418-D	55
440-13X	7	440-3-SFX	20	446-0X	7	480-TX-50-H	16	49-27IPX	19	49-A-TX-08	17	49-TX-20-5	17	5420-D	55
440-15IPRX	18	440-3X	7	446-12X	7	480-TX-50X	16	492-A-27X	8	49-A-TX-09	17	49-TX-20-W	17	5421-D	55
440-15IPX	18	440-40IPRX	18	446-1-PZDX	19	480-TX-55-H	16	492-A-ACR2-DX	8	49-A-TX-10	17	49-TX-25	17	5422-D	55
440-1-ACR1-DX	7	440-40IPX	18	446-1X	7	480-TX-55X	16	492-A-ACR2X	8	49-A-TX-10-H	17	49-TX-25-W	17	5424-D	55
440-1-ACR1-DX	7	440-4-PZDX	19	446-215T	7	482X	8	492-ACR2-DX	8	49-A-TX-15	17	49-TX-27	17	5426-D	55
440-1-ACR1-RX	7	440-4X	7	446-215X	7	483X	8	492-ACR2-RX	8	49-A-TX-15-H	17	49-TX-27-W	17	5430-D	55
440-1-ACR1-RX	7	440-FX	21	446-225T	7	484X	8	492-ACR2X	8	49-A-TX-15-W	17	49-TX-30	17	5432-D	55
440-1-ACR1X	7	440-MT-0	28	446-22TX	7	485-1X	13	492-AFX	21	49-A-TX-20	17	49-TX-30-W	17	5434-D	55
440-1-ACR1X	7	440-MT-00	28	446-22X	7	485-2X	13	492-AI	8	49-A-TX-20-H	17	49-TX-40	17	5436-D	55
440-1-PZDX	19	440-MT-1	28	446-23T	7	485-3X	13	492-A-PZDX	19	49-A-TX-25	17	4MM11	43	5440-D	55
440-1-SFX	20	440-MT-2	28	446-27X	7	485-4X	13	492-A-SFX	20	49-A-TX-27	17	4MME1	44	5512-D	56
440-1X	7	440-TSQ-10M	27	446-2-ACR2-DX	7	485-5X	13	492-AX	8	49-A-TX-30	17	5,5MM11	43	5514-D	56
440-20IPRX	18	440-TSQ-4M	27	446-2-ACR2-DX	7	485-6X	13	492-B-27X	8	49-A-TX-40	17	5,5MM21	43	5516-D	56
440-20IPX	18	440-TSQ-5M	27	446-2I	7	485-7X	13	492-B-ACR2-DX	8	49-B-10IPX	19	5,5MME1	44	5518-D	56
440-215-PZDX	19	440-TSQ-6M	27	446-2-PZDX	19	48-TSQ-10M	27	492-B-ACR2X	8	49-B-15IPX	19	501-AX	9	551X	9
440-215-SFX	20	440-TSQ-8M	27	446-2-SFX	20	48-TSQ-12M	27	492-BFX	21	49-B-20IPX	19	501X	9	5520-D	56
440-215X	7	440-TX-05X	16	446-2X	7	48-TSQ-14M	27	492-BI	8	49-B-25IPX	19	502-ACR2X	9	5522-D	56

Part Number Index

Number	Page	Number	Page	Number	Page	Number	Page	Number	Page	Number	Page	Number	Page	Number	Page
5524-D	56	6MM43	50	7180-D	68	8MM13-D	50	A-3-14MM	83	AM-06-3	23	APSS38L	48	EX-1101	73
5526-D	56	6MME1	44	7324-D	68	8MM21	43	A-3-15MM	83	AM-06-4	23	APSS511M	63	EX-250	35
5528-D	56	6N-0806-2	33	7324SKT	68	8MM21-D	43	A-316	83	AM-06-6	23	APSS58XL	58	EX-250-12	35
552-FX	21	6N-0806-3	33	7330-D	68	8MM23	50	A-3-16MM	83	AM-07	23	APU37	49	EX-250-2	35
552I	9	6N-0808-2	33	7332-D	68	8MM23-D	50	A-3-17MM	83	AM-08	23	APU37M	52	EX-250-2	76
552X	9	6N-0808-3	33	7336-D	68	8MM43	50	A-318	83	AM-1.5MM	23	APU56	59	EX-250-3	35
5530-D	56	6N-0808-4	33	7424-D	68	8MM43-D	50	A-3-18MM	83	AM-10	23	APU56M	63	EX-250-4	35
5532-D	56	6N-0808-5	33	7428-D	68	8MME1	44	A-3-19MM	83	AM-10MM	23	AS-06	23	EX-250-4	76
5534-D	56	6N-0808-6	33	7430-D	68	8MME3	51	A-320	83	AM-2.5MM	23	AS-10	23	EX-250-5	35
553X	9	6N-0810-2	33	7442-D	68	950-0X	26	A-322	83	AM-2MM	23	AS-12	23	EX-250-6	35
55-TX-10	18	6N-0810-3	33	7530-D	68	950-1X	26	A-324	83	AM-3MM	23	AW-95	34	EX-250-6	76
55-TX-15	18	6N-0810-4	33	7536-D	68	950-2X	26	A-328	83	AM-3MM-3	23	AW-95-L	34	EX-250-8	35
55-TX-20	18	6N-0810-5	33	7MM03	50	950-3X	26	A-5-10MM	83	AM-3MM-4	23	AW-95-LL	34	EX-250-B	35
55-TX-25	18	6N-0810-6	33	7MM11	43	950-QD-2	20	A-5-11MM	83	AM-4MM	23	BNAE-3MM	21	EX-250-B-12	35
55-TX-30	18	6N-08-10M-3	33	7MM11-D	43	954-0X	26	A-512	83	AM-5MM	23	BNAE-4MM	21	EX-250-B-2	35
5610-D	58	6N-08-10M-4	33	7MM13	50	954-1X	26	A-5-12MM	83	AM-5MM-4	23	BNAE-4MM-ACR	21	EX-250-B-3	35
5612-D	58	6N-08-10M-6	33	7MM21	43	954-2X	26	A-5-13MM	83	AM-6MM	23	BNAE-5MM	21	EX-250-B-4	35
5614-D	58	6N-0811-2	33	7MM23	50	954-3X	26	A-514	83	AM-6MM-4	23	BNAE-5MM-ACR	21	EX-250-B-5	35
5616-D	58	6N-0811-3	33	7MM43	50	954-A-0X	26	A-5-14MM	83	AM-7MM	23	BNAE-6MM	21	EX-250-B-6	35
5618-D	58	6N-0812-2	33	7MM43-D	50	954-A-1X	26	A-5-15MM	83	AM-8MM	23	BNAE-6MM-ACR	21	EX-250-B-8	35
5620-D	58	6N-0812-3	33	7MME1	44	954-A-2X	26	A-516	83	AM-MT-0	28	BNAE-8MM	21	EX-251	35
5624-D	58	6N-0812-4	33	8124-D	71	954-A-3X	26	A-5-16MM	83	AM-MT-1	28	BW-848	72	EX-251-10	35
5636-D	58	6N-0812-6	33	8128-D	71	954-B-1X	26	A-5-17MM	83	AM-MT-2	28	BW-848-F	72	EX-251-2	35
5724-D	58	6N-08-12M-3	33	8130-D	71	954-B-2X	26	A-518	83	AN-04	24	BW-8626	72	EX-251-3	35
5816-D	58	6N-08-12M-4	33	8132-D	71	954-B-3X	26	A-5-18MM	83	AN-04-A	24	CMS-1408	44	EX-251-6	35
5820-D	58	6N-08-12M-6	33	8134-D	71	954-C-0X	26	A-5-19MM	83	AN-05	24	CMS-1409	44	EX-251-8	35
5822-D	58	6N-0814-2	33	8136-D	71	954-C-1X	26	A-520	83	AN-05-6	24	CMS-1410	44	EX-251-B	35
5826-D	58	6N-0814-3	33	8138-D	71	954-C-2X	26	A-5-20MM	83	AN-06	24	CMS-1412	44	EX-251-B-2	35
5832-D	58	6N-0814-4	33	8140-D	71	954-C-3X	26	A-5-21MM	83	AN-06-6	24	CMS-1414	44	EX-252	45
5834-D	58	6N-0814-6	33	8142-D	71	95-A-QD-2	20	A-522	83	AN-07	24	CMS-1507	44	EX-252-B	45
5836-D	58	6N-0816-2	33	8144-D	71	95-B-QD-2	20	A-5-22MM	83	AN-07-8	24	CMS-1508	44	EX-254	54
5912-D	58	6N-0816-3	33	8146-D	71	95-QD-2	20	A-5-23MM	83	AN-08	24	CMS-1509	44	EX-254-B	54
5914-D	58	6N-0818-2	33	8148-D	71	95-QD-3	20	A-524	83	AN-08-8	24	CMS-1510	44	EX-255-10	45
5918-D	58	6N-08-8M-3	33	8150-D	71	9MM11	43	A-5-24MM	83	AN-09	24	CMS-3412	53	EX-255-12	45
591-PZDX	19	6N-08-8M-4	33	8162-D	71	9MM11-D	43	A-5-25MM	83	AN-10	24	CMS-3414	53	EX-255-14	45
591X	9	6N-08-8M-6	33	822-F	21	9MM13	50	A-526	83	AN-10-6	24	CMS-3416	53	EX-255-2	45
592-PZDX	19	6N-1410-3	34	830-1X	8	9MM13-D	50	A-528	83	AN-10MM	24	CMS-3418	53	EX-255-3	45
592X	9	6N-1412-3	34	830-2X	8	9MM21	43	A-530	83	AN-12	24	CMS-3420	53	EX-255-4	45
5MM11	43	6N-1414-3	34	830-3X	8	9MM21-D	43	A-534	83	AN-12-6	24	CMS-3512	53	EX-255-6	45
5MM21	43	6N-1416-3	34	830-4X	8	9MM23	50	A-536	83	AN-12MM	24	CMS-3518	53	EX-255-8	45
5P12	57	6N-1416-4	34	832-F	21	9MM23-D	50	A-538	83	AN-14MM	24	CMS-5416	64	EX-255-B-2	45
5P14	57	6N-1418-3	34	833-F	21	9MM43	50	A-540	83	AN-14MM-6	24	CMS-5422	64	EX-255-B-4	45
610 2 51	31	6N-1418-6	34	834-F	21	9MM43-D	50	AM-01-A	23	AN-16	24	CMS-5426	64	EX-255-B-6	45
6120-D	66	6N-1420-3	34	834-TX-25	18	9MME1	44	AM-02	23	AN-16-6	24	CMS-5430	64	EX-257-2	54
635-10X	14	6N-1424-3	34	834-TX30-1,62	18	A-108	83	AM-02-A	23	AN-3MM	24	DB-08	33	EX-257-3	54
635-6X	14	6N-1424-6	34	834-TX40-2,95	18	A-110	83	AM-03	23	AN-4MM	24	DB-10	33	EX-257-4	54
635-7X	14	6N-2028-4	34	834-TX-45-5 T-45	18	A-1-10MM	83	AM-03-3	23	AN-5MM	24	DB-12	33	EX-257-5	54
635-8X	14	6N-2036-4	34	834-TX-50 T-50	18	A-1-11MM	83	AM-03-6	23	AN-6MM	24	EX-1000	70	EX-257-6	54
635-9X	14	7120-D	68	834-TX50-1,62	18	A-112	83	AM-03-A	23	AN-8MM	24	EX-1000-B	70	EX-257-B-2	54
6520-D	66	7122-D	68	8430-D	71	A-1-12MM	83	AM-04	23	AN-MT-3	28	EX-1001	72	EX-257-B-3	54
6524-D	66	7124-D	68	8432-D	71	A-1-13MM	83	AM-04-3	23	AN-MT-4	28	EX-1001-B	72	EX-257-B-4	54
6528-D	66	7128-D	68	8440-D	71	A-114	83	AM-04-35	23	AP-08	24	EX-1003-10	72	EX-257-B-5	54
6B-0808	34	7130-D	68	8442-D	71	A-116	83	AM-04-4	23	AP-10	24	EX-1003-12	72	EX-257-B-6	54
6B-0809	34	7132-D	68	8444-D	71	A-118	83	AM-04-5	23	AP-12	24	EX-1003-15	72	EX-258-4	64
6B-0810	34	7134-D	68	8448-D	71	A-120	83	AM-04-6	23	AP-16	24	EX-1003-4	72	EX-258-B-2	64
6B-0811	34	7136-D	68	854-TX-50 T-50	18	A-1-6MM	83	AM-04-A	23	AP-18	24	EX-1003-6	72	EX-260	64
6B-0812	34	7140-D	68	854-TX-55-150M	18	A-1-7MM	83	AM-04-A-4	23	AP-20	24	EX-1003-8	72	EX-260-B	64
6B-0814	34	7142-D	68	8638-D	72	A-1-8MM	83	AM-05	23	AP-24	24	EX-1003-B-10	72	EX-262 5/16	35
6B-0816	34	7148-D	68	8640-D	72	A-1-9MM	83	AM-05-3	23	APH35M	25	EX-1003-B-12	72	EX-262-4	35
6B-0818	34	7152-D	68	8646-D	72	A-3-10MM	83	AM-05-35	23	APH38	25	EX-1003-B-15	72	EX-262-6	35
6B-0820	34	7154-D	68	8652-D	72	A-3-11MM	83	AM-05-4	23	APH56	25	EX-1003-B-4	72	EX-262-B-4	35
6MM11	43	7160-D	68	8MM03	50	A-312	83	AM-05-5	23	APH56M	25	EX-1003-B-6	72	EX-370	35
6MM11-D	43	7164-D	68	8MM11	43	A-3-12MM	83	AM-05-6	23	APS312LM	52	EX-1003-B-8	72	EX-370-10	35
6MM13	50	7170-D	68	8MM11-D	43	A-3-13MM	83	AM-05-8	23	APS312M	52	EX-1005	73	EX-370-2	35
6MM21	43	7172-D	68	8MM13	50	A-314	83	AM-06	23	APS38	48	EX-1005-B	73	EX-370-2	76

Part Number Index

Number	Page	Number	Page	Number	Page	Number	Page	Number	Page	Number	Page	Number	Page	Number	Page
EX-370-3	35	EX-377-B-10	64	EX-508-12	76	EX-751	65	FL-3318	48	HTS-12	29	KB-205-12	37	KC-6-9M-6	37
EX-370-4	35	EX-377-B-12	64	EX-508-15	64	EX-751-B	65	FL-3320	48	HTS-2	29	KB-205-6	37	KC-6-9M-6	37
EX-370-4	76	EX-377-B-2 3/8	64	EX-508-16	64	EX-752 3/4 5/8	67	FL-3324	48	HTS-3	29	KB-317-9	37	KC-7-11M-6	37
EX-370-5	35	EX-377-B-3	64	EX-508-18	64	EX-752-B	67	FL-3326	48	HTS-3A	29	KB-318-12	37	KC-7-11M-6	37
EX-370-6	35	EX-377-B-4	64	EX-508-2	64	EX-753	70	FL-3412	47	HTS-4	29	KB-320-6	37	KC-7-12M-3	37
EX-370-6	76	EX-377-B-5	64	EX-508-3	64	EX-753-B	70	FL-3414	47	HTS-4A	29	KB-321-6	37	KC-7-12M-3	37
EX-370-8	35	EX-377-B-6	64	EX-508-4	64	EX-754	73	FL-5114	56	HTS-5	29	KB-322-3	37	KC-7-12M-6	37
EX-370-B	35	EX-377-B-9	64	EX-508-4	76	EX-754-B	73	FL-5116	56	HTS-6	29	KB-322-6	37	KC-7-12M-6	37
EX-370-B-10	35	EX-380	35	EX-508-5	64	EX-755-10	70	FL-5118	56	HTS-7	29	KB-43-6	37	KC-7-12M-9	37
EX-370-B-2	35	EX-380-2	35	EX-508-6	64	EX-755-12	70	FL-5120	56	HTS-8	29	KB-45-3	37	KC-7-12M-9	37
EX-370-B-3	35	EX-380-3	35	EX-508-8	64	EX-755-15	70	FL-5122	56	HTS-9	29	KB-45-4	37	KC-7-13M-3	37
EX-370-B-4	35	EX-380-4	35	EX-508-8	76	EX-755-4	70	FL-5124	56	KA-103-6	49	KB-6-10M-6	37	KC-7-13M-3	37
EX-370-B-6	35	EX-380-6	35	EX-508-9	64	EX-755-6 3/4	70	FL-5126	56	KA-104-9	49	KB-7-11M-6	37	KC-7-13M-6	37
EX-370-B-8	35	EX-380-B	35	EX-508-B-10	64	EX-755-8	70	FL-5128	56	KA-105-3	49	KB-7-13M-12	37	KC-7-13M-6	37
EX-371	35	EX-380-B-2	35	EX-508-B-12	64	EX-755-B-12	70	FL-5130	56	KA-105-4	49	KB-7-13M-3	37	KC-7-13M-9	37
EX-371-10	35	EX-500-2	36	EX-508-B-15	64	EX-755-B-15	70	FL-5132	56	KA-105-6	49	KB-7-13M-6	37	KC-7-13M-9	37
EX-371-12	35	EX-500-3	36	EX-508-B-2	64	EX-755-B-4	70	FL-5134	56	KA-105-9	49	KB-7-13M-9	37	KCM-25-B-6	83
EX-371-15	35	EX-500-4	36	EX-508-B-3	64	EX-755-B-6	70	FL-5216	57	KA-205-3	49	KB-7-14M-6	37	KCM-37-6	83
EX-371-2	35	EX-500-6	36	EX-508-B-4	64	EX-755-B-8	70	FL-5218	57	KA-43-6	49	KB-8-15M-12	37	KD-103-6	49
EX-371-2	35	EX-500-B-2	36	EX-508-B-5	64	EX-756-4	73	FL-5222	57	KA-44-3	49	KB-8-15M-6	37	KD-104-12	49
EX-371-3	35	EX-500-B-3	36	EX-508-B-6	64	EX-756-6	73	FL-5224	57	KA-44-4	49	KB-8-15M-9	37	KD-105-3	49
EX-371-4	35	EX-500-B-4	36	EX-508-B-8	64	EX-756-8	73	FL-5226	57	KA-44-6	49	KB-8-16M-6	37	KD-105-6	49
EX-371-5	35	EX-500-B-6	36	EX-508-B-9	64	EX-757-3	36	FL-5228	57	KA-45-3	49	KB-8-16M-9	37	KD-205-6	49
EX-371-6	35	EX-501-10	36	EX-509-10	67	EX-757-B-3	36	FL-5316	57	KA-45-4	49	KB-8-17M-12	37	KD-43-6	49
EX-371-8	35	EX-501-12	36	EX-509-12	67	EX-758-4	36	FL-5318	57	KA-45-6	49	KB-8-18M-6	37	KD-44-6	49
EX-371-B-3	35	EX-501-15	36	EX-509-3	67	EX-758-6	36	FL-5320	57	KA-45-9	49	KC-101-6	37	KD-45-6	49
EX-372	45	EX-501-2	36	EX-509-4	67	EX-758-9	36	FL-5324	57	KA-6-10M-4	52	KC-105-6	37	KD-6-10M-12	52
EX-372-B	45	EX-501-3	36	EX-509-5	67	EX-758-B-4	36	FL-5326	57	KA-6-10M-6	52	KC-25-12	37	KD-6-10M-6	52
EX-374	54	EX-501-4	36	EX-509-6	67	EXL-1000	81	FL-5416	56	KA-6-10M-9	52	KC-25-3	37	KD-6-10M-9	52
EX-374-B	54	EX-501-5	36	EX-510-3	70	EXL-1100	81	FL-5418	56	KA-7-11M-12	52	KC-25-4	37	KD-7-11M-12	52
EX-375 3/8	64	EX-501-6	36	EX-510-4	70	EXL-15	81	FL-6124	66	KA-7-12M-12	52	KC-25-6	37	KD-7-11M-6	52
EX-375-B 3/8	64	EX-501-8	36	EX-510-6	70	FC-310	80	FL-6128	66	KA-7-12M-4	52	KC-25-9	37	KD-7-12M-12	52
EX-376-10	54	EX-501-B-10	36	EX-510-8	70	FC-312	80	FL-6324	66	KA-7-12M-6	52	KC-26-12	37	KD-7-12M-6	52
EX-376-12	54	EX-501-B-12	36	EX-510-B-3	70	FL-1108	41	FL-HE-9518	57	KA-7-12M-9	52	KC-26-3	37	KD-7-12M-9	52
EX-376-12	76	EX-501-B-2	36	EX-510-B-4	70	FL-1109	41	FL-SH-335	56	KA-7-13M-12	52	KC-26-6	37	KD-7-13M-12	52
EX-376-15	54	EX-501-B-3	36	EX-510-B-5	70	FL-1110	41	FL-SW-493	57	KA-7-13M-3	52	KC-26-9	37	KD-7-13M-6	52
EX-376-18	54	EX-501-B-4	36	EX-510-B-6	70	FL-1112	41	HA-510	41	KA-7-13M-4	52	KC-27-3	37	KD-7-13M-9	52
EX-376-2	54	EX-501-B-5	36	EX-510-B-8	70	FL-1114	41	HC-100-1/2	80	KA-7-13M-6	52	KC-27-6	37	KD-7-14M-6	52
EX-376-3	54	EX-501-B-6	36	EX-512-2	36	FL-1116	41	HC-100-1/4	80	KA-7-13M-9	52	KC-28-3	37	KD-7-14M-9	52
EX-376-3	76	EX-501-B-8	36	EX-512-3	36	FL-1212	41	HC-100-10	80	KA-7-14M-6	52	KC-28-6	37	KD-8-15M-12	52
EX-376-4	54	EX-502	36	EX-512-B-2	36	FL-1214	41	HC-100-3/4	80	KA-8-15M-12	52	KC-29-3	37	KD-8-15M-6	52
EX-376-5	54	EX-502-3	36	EX-512-B-4	36	FL-1216	41	HC-100-3/8	80	KA-8-15M-3	52	KC-29-6	37	KD-8-15M-9	52
EX-376-6	54	EX-502-5	36	EX-620-3	36	FL-3012	47	HC-100-5/16	80	KA-8-15M-9	52	KC-30-3	37	KDM-37-6	54
EX-376-6	76	EX-502-6	36	EX-620-6	36	FL-3014	47	HC-100-5/8	80	KAM-37-3	54	KC-30-4	37	KDM-37-B-3	54
EX-376-8	54	EX-502-8	36	EX-621-3	36	FL-3016	47	HC-100-7/16	80	KAM-38-6	54	KC-30-6	37	KDM-38-6	54
EX-376-9	54	EX-502-B	36	EX-621-6	36	FL-3018	47	HC-3520	46	KAW-C-104-9	49	KC-30-9	37	KDW-C-104-12	49
EX-376-B-10	54	EX-502-B-3	36	EX-621-8	36	FL-3022	47	HC-3816	46	KAW-C-105-6	49	KC-5-7M-4	37	KDW-C-105-6	49
EX-376-B-12	54	EX-502-B-4	36	EX-621-B-3	36	FL-3024	47	HE-100-1/2	80	KAW-C-43-6	49	KC-5-7M-4	37	KDW-C-43-6	49
EX-376-B-15	54	EX-503	54	EX-622	54	FL-3110	47	HE-100-1/4	80	KAW-C-44-6	49	KC-5-7M-6	37	KDW-C-44-6	49
EX-376-B-2	54	EX-503-B	54	EX-623	65	FL-3112	47	HE-100-3/4	80	KAW-C-45-6	49	KC-5-7M-6	37	KDW-C-45-6	49
EX-376-B-3	54	EX-504	64	EX-623-B	65	FL-3114	47	HE-100-3/8	80	KAW-C-6-10M-6	52	KC-6-10M-12	37	KDW-C-6-10M-6	52
EX-376-B-4	54	EX-504-B	64	EX-624	67	FL-3116	47	HE-100-5/16	80	KAW-C-6-10M-9	52	KC-6-10M-12	37	KDW-C-6-10M-9	52
EX-376-B-5	54	EX-505	67	EX-624-B	67	FL-3118	47	HE-100-5/8	80	KAW-C-7-12M-12	52	KC-6-10M-3	37	KDW-C-7-12M-12	52
EX-376-B-6	54	EX-505-B	67	EX-625	70	FL-3120	47	HE-100-7/16	80	KAW-C-7-12M-6	52	KC-6-10M-3	37	KDW-C-7-12M-6	52
EX-376-B-8	54	EX-506	70	EX-625-B	70	FL-3122	47	HE-1028	55	KAW-C-7-13M-12	52	KC-6-10M-4	37	KDW-C-7-13M-12	52
EX-376-B-9	54	EX-506-B	70	EX-626-3	65	FL-3124	47	HE-1028-D	55	KAW-C-7-13M-6	52	KC-6-10M-4	37	KDW-C-7-13M-6	52
EX-377-10	64	EX-507-2	54	EX-627-10	67	FL-3210	48	HE-530	55	KAW-C-7-14M-6	52	KC-6-10M-6	37	KDW-C-7-14M-6	52
EX-377-12	64	EX-507-3	54	EX-627-12	67	FL-3212	48	HT-848	81	KAW-C-8-15M-9	52	KC-6-10M-6	37	KDW-C-8-15M-9	52
EX-377-15	64	EX-507-4	54	EX-627-3	67	FL-3214	48	HTN-B-1	29	KB-10-19M-6	37	KC-6-10M-9	37	KH-10-19M-12	63
EX-377-2 3/8	64	EX-507-6	54	EX-627-4	67	FL-3216	48	HTN-B-2	29	KB-104-6	37	KC-6-10M-9	37	KH-10-19M-3	63
EX-377-3 3/8	64	EX-507-B-3	54	EX-627-6	67	FL-3218	48	HTN-B-3	29	KB-105-3	37	KC-6-8M-3	37	KH-10-19M-6	63
EX-377-4	64	EX-507-B-4	54	EX-627-8	67	FL-3220	48	HTN-B-4	29	KB-202-12	37	KC-6-8M-3	37	KH-10-19M-9	63
EX-377-5	64	EX-507-B-6	54	EX-628-3	70	FL-3312	48	HTS-0	29	KB-202-6	37	KC-6-8M-4	37	KH-104-6	59
EX-377-6	64	EX-508-10	64	EX-750	54	FL-3314	48	HTS-1	29	KB-203-12	37	KC-6-8M-4	37	KH-105-12	59
EX-377-8	64	EX-508-12	64	EX-750-B	54	FL-3316	48	HTS-10	29	KB-203-9	37	KC-6-8M-6	37	KH-105-3	59

Part Number Index

Number	Page	Number	Page	Number	Page	Number	Page	Number	Page	Number	Page	Number	Page	Number	Page
KH-105-6	59	KN-104-6	59	KS-100-6	37	KT-8-15M-6	37	M-13MME5	62	M-322X	15	M-5316	56	M-7MME1	44
KH-202-6	59	KN-104-9	59	KS-102-6	37	KT-8-15M-9	37	M-14MM11	43	M-328X	15	M-5416	56	M-7MME3	51
KH-203-4	59	KN-105-12	59	KS-104-6	37	KT-8-16M-12	37	M-14MM13	50	M-32-TX-15	17	M-5418	56	M-825	33
KH-203-6	59	KN-105-6	59	KS-105-6	37	KT-8-16M-6	37	M-14MM15	61	M-32-TX-20	17	M-5420	56	M-825	76
KH-203-9	59	KN-105-9	59	KS-105-9	37	KT-8-16M-9	37	M-14MM43	51	M-3408	47	M-5512	56	M-83	33
KH-205-12	59	KN-202-6	59	KS-25-6	37	KT-8-17M-6	37	M-14MM45	61	M-3410	47	M-5518	56	M-835	33
KH-205-3	59	KN-202-8	59	KS-26-12	37	KT-8-18M-12	37	M-1500-P	34	M-3411	47	M5E10	57	M-835	76
KH-205-4	59	KN-203-12	59	KS-26-6	37	KT-8-18M-6	37	M-1505-P	34	M-3412	47	M5E12	57	M-838	76
KH-205-6	59	KN-203-6	59	KS-28-12	37	KT-8-18M-9	37	M-15MM03	50	M-3414	47	M5E14	57	M-855	33
KH-318-4	59	KN-203-9	59	KS-28-6	37	L-320X	15	M-15MM11	43	M-3416	47	M5E16	57	M-855	76
KH-320-6	59	KN-205-12	59	KS-29-6	37	L-322X	15	M-15MM13	50	M-3418	47	M5E18	57	M-858	33
KH-321-6	59	KN-205-6	59	KS-30-6	37	L-328X	15	M-15MM15	61	M-3424	47	M-5MM11	43	M-858	76
KH-322-6	59	KN-205-9	59	KS-5-7M-6	37	M-10MM03	50	M-15MM25	61	M-3426	47	M-5MME1	44	M-8MM11	43
KH-409-12	59	KN-318-3	59	KS-5-7M-6	37	M-10MM11	43	M-15MM35	61	M-3514	47	M5P10	57	M-8MM13	50
KH-409-3	59	KN-318-4	59	KS-5-7M-9	37	M-10MM13	50	M-15MM4	51	M3E08	48	M5P12	57	M-8MM21	43
KH-409-4	59	KN-320-12	59	KS-5-7M-9	37	M-10MM13	76	M-15MM45	61	M3E10	48	M5P14	57	M-8MM43	51
KH-409-6	59	KN-322-12	59	KS-6-10M-6	37	M-10MM15	61	M-15MME5	62	M3E12	48	M5P16	57	M-8MME1	44
KH-43-6	59	KN-322-6	59	KS-6-10M-6	37	M-10MM21	43	M-15-SC	34	M3E14	48	M5P18	57	M-8MME3	51
KH-44-6	59	KN-322-9	59	KS-6-10M-9	37	M-10MM21	76	M-15-SC-A	34	M3E16	48	M-61	31	M-9MM11	43
KH-45-3	59	KN-404-6	59	KS-6-10M-9	37	M-10MM23	76	M-16MM13	50	M3E18	48	M-630	31	M-9MM13	50
KH-45-4	59	KN-43-6	59	KS-6-8M-6	37	M-10MM43	51	M-16MM15	61	M3P06	48	M-638	31	M-9MM21	43
KH-45-6	59	KN-43-9	59	KS-6-8M-6	37	M-10MME1	44	M-17MM13	50	M3P07	48	M-6MM11	43	M-9MME1	44
KH-8-15M-3	63	KN-44-6	59	KS-6-8M-9	37	M-10MME3	51	M-17MM15	61	M3P08	48	M-6MM13	50	MB-10MM21	43
KH-7-13M-4	63	KN-45-6	59	KS-6-8M-9	37	M-1105	41	M-18MM03	50	M3P10	48	M-6MM21	43	MB-10MM21	76
KH-7-13M-6	63	KN-45-9	59	KS-7-11M-6	37	M-1106	41	M-18MM13	50	M3P12	48	M-6MME1	44	MB-10MM23	51
KH-7-13M-9	63	KN-7-12M-6	63	KS-7-11M-6	37	M-1107	41	M-18MM15	61	M3P14	48	M-6MME3	51	MB-10MM23	76
KH-7-14M-6	63	KN-7-12M-9	63	KS-7-13M-6	37	M-1108-E	41	M-18MM25	61	M3P16	48	M6N-0806-2	33	MB-10MM25	61
KH-8-15M-3	63	KN-7-13M-12	63	KS-7-13M-6	37	M-1110	41	M-18MM35	61	M3P18	48	M6N-0806-3	33	MB-10MM33	51
KH-8-15M-6	63	KN-7-13M-6	63	KS-7-13M-9	37	M-1112	41	M-18MM55	61	M-44-90	31	M6N-0806-5	33	MB-11MM21	43
KH-8-15M-9	63	KN-7-13M-9	63	KS-7-13M-9	37	M-1114	41	M-19MM15	61	M-450	31	M6N-0806-6	33	MB-11MM23	51
KH-8-16M-12	63	KN-7-14M-6	63	KSM-25-3	83	M-1116	41	M1E06	42	M-460	31	M6N-0808-2	33	MB-1206	41
KH-8-16M-3	63	KN-7-14M-9	63	KSM-25-B-6	83	M-1118	41	M1E07	42	M-470	31	M6N-0808-3	33	MB-1208	41
KH-8-16M-4	63	KN-8-15M-12	63	KSM-37-6	83	M-11MM03	50	M1E08	42	M-480	31	M6N-0808-4	33	MB-1209	41
KH-8-16M-9	63	KN-8-15M-6	63	KSM-37-B-6	83	M-11MM11	43	M1E10	42	M-480-6	31	M6N-0808-5	33	MB-1210	41
KH-8-17M-3	63	KN-8-15M-9	63	KT-10-19M-6	37	M-11MM13	50	M1E11	42	M-488	31	M6N-0808-6	33	MB-1211	41
KH-8-17M-4	63	KN-8-16M-12	63	KT-104-6	37	M-11MM15	61	M1E12	42	M-490	31	M6N-0810-2	33	MB-1212	41
KH-8-17M-6	63	KN-8-16M-9	63	KT-105-12	37	M-11MM21	43	M1E14	42	M-490	76	M6N-0810-3	33	MB-1214	41
KH-8-17M-9	63	KN-8-17M-6	63	KT-105-6	37	M-11MM43	51	M1E16	42	M-490-10	31	M6N-0810-4	33	MB-1216	41
KH-8-18M-3	63	KN-8-17M-9	63	KT-105-9	37	M-11MME1	44	M1P06	42	M-490-12	31	M6N-0810-5	33	MB-1218	41
KH-8-18M-4	63	KN-8-18M-12	63	KT-202-12	37	M-11MME3	51	M1P07	42	M-490-2	31	M6N-0810-6	33	MB-12MM21	43
KH-8-18M-6	63	KN-8-18M-6	63	KT-202-6	37	M-1208	41	M1P08	42	M-490-2-OR	31	M6N-08-10M-3	33	MB-12MM23	51
KH-8-18M-9	63	KN-8-18M-9	63	KT-202-9	37	M-1209	41	M1P09	42	M-490-4	31	M6N-08-10M-4	33	MB-12MM25	61
KHM-37-6	65	KNM-37-6	65	KT-203-12	37	M-1210	41	M1P10	42	M-490-4	76	M6N-08-10M-6	33	MB-1308	41
KHM-38-6	65	KNM-38-6	65	KT-203-6	37	M-1212	41	M1P11	42	M-490-6	31	M6N-0811-2	33	MB-1311	41
KHM-50-6	65	KNM-50-6	65	KT-203-9	37	M-1214	41	M1P12	42	M-490-6	76	M6N-0811-3	33	MB-1312	41
KHM-50-B-6	65	KNM-50-B-6	65	KT-205-12	37	M-12MM03	50	M1P14	42	M-490-8	31	M6N-0812-2	33	MB-1314	41
KHW-C-105-12	59	KNW-C-105-12	59	KT-205-6	37	M-12MM11	43	M1P16	42	M-490-NR	31	M6N-0812-3	33	MB-13MM21	43
KHW-C-105-6	59	KNW-C-105-6	59	KT-317-9	37	M-12MM13	50	M-21MM15	61	M-490-OR	31	M6N-0812-4	33	MB-13MM23	51
KHW-C-205-12	59	KNW-C-205-12	59	KT-318-6	37	M-12MM15	61	M-3012	47	M-495	31	M6N-0812-6	33	MB-13MM23	76
KHW-C-205-6	59	KNW-C-205-6	59	KT-320-12	37	M-12MM21	43	M-3014	47	M-495-5	31	M6N-08-12M-3	33	MB-13MM25	61
KHW-C-322-6	59	KNW-C-322-12	59	KT-320-6	37	M-12MM43	51	M-3016	47	M-497	31	M6N-08-12M-4	33	MB-13MM33	51
KHW-C-409-6	59	KNW-C-322-6	59	KT-320-9	37	M-12MME1	44	M-3018	47	M-498	31	M6N-08-12M-6	33	MB-14MM21	43
KHW-C-43-6	59	KNW-C-43-6	59	KT-322-6	37	M-13MM03	50	M-3108	47	M-4MME1	44	M6N-0814-2	33	MB-14MM23	51
KHW-C-44-6	59	KNW-C-44-6	59	KT-322-9	37	M-13MM11	43	M-3109	47	M-5,5MM11	43	M6N-0814-3	33	MB-14MM25	61
KHW-C-45-6	59	KNW-C-45-6	59	KT-44-6	37	M-13MM13	50	M-3110	47	M-5,5MME1	44	M6N-0814-4	33	MB-15MM21	43
KHW-C-7-13M-6	63	KNW-C-7-13M-6	63	KT-6-10M-12	37	M-13MM15	61	M-3112	47	M-5110	56	M6N-0814-6	33	MB-15MM23	51
KHW-C-7-13M-9	63	KNW-C-7-13M-9	63	KT-6-10M-6	37	M-13MM21	43	M-3114	47	M-5112	56	M6N-0816-2	33	MB-15MM25	61
KHW-C-7-14M-6	63	KNW-C-7-14M-6	63	KT-6-10M-9	37	M-13MM23	76	M-3116	47	M-5114	56	M6N-0816-3	33	MB-15MM33	51
KHW-C-8-15M-6	63	KNW-C-8-15M-12	63	KT-7-13M-6	37	M-13MM25	61	M-3118	47	M-5116	56	M6N-0818-2	33	MB-15MM35	61
KHW-C-8-15M-9	63	KNW-C-8-15M-6	63	KT-7-13M-9	37	M-13MM35	61	M-3120	47	M-5118	56	M6N-08-8M-3	33	MB-16MM21	43
KHW-C-8-16M-9	63	KNW-C-8-16M-9	63	KT-7-14M-12	37	M-13MM43	51	M-320X	15	M-5120	56	M6N-08-8M-4	33	MB-16MM23	51
KHW-C-8-17M-6	63	KNW-C-8-17M-6	63	KT-7-14M-6	37	M-13MM45	61	M-3212	47	M-5122	56	M6N-08-8M-6	33	MB-16MM25	61
KHW-C-8-17M-9	63	KNW-C-8-17M-9	63	KT-7-15M-6	37	M-13MM55	61	M-3214	47	M-5124	56	M-7MM11	43	MB-17MM23	51
KHW-C-8-18M-6	63	KNW-C-8-18M-6	63	KT-8-13M-12	37	M-13MME1	44	M-3216	47	M-5216	56	M-7MM13	50	MB-18MM21	51
KHW-C-8-18M-9	63	KNW-C-8-18M-9	63	KT-8-15M-12	37	M-13MME3	51	M-3218	47	M-5218	56	M-7MM2	43	MB-18MM25	61

Part Number Index

Number	Page	Number	Page	Number	Page	Number	Page	Number	Page	Number	Page	Number	Page	Number	Page
MB-18MM35	61	MF-62B	67	OSSF-3514	48	S-32-TX-30	17	SA-410	58	SC-108	33	SF-12MM35	62	SF-19MM15	62
MB-3210	47	MF-70	65	OSSF-8MM23	51	SA-120	49	SA-411	58	SC-114	33	SF-12MM43	51	SF-19MM16	67
MB-3212	47	MF-70B	65	P-1408	26	SA-120	58	SA-501	58	SC-308	33	SF-12MM45	62	SF-19MM23	51
MB-3214	47	MF-75	70	P-1409	26	SA-120-D	49	SA-505	58	SC-314	24	SF-13MM03	51	SF-19MM25	62
MB-3216	47	MF-75B	70	P-1410	26	SA-120-D	58	SA-508	58	SC-314	25	SF-13MM11	43	SF-19MM35	62
MB-3218	47	MF-76	70	P-1412	26	SA-122	49	SA-510	58	SC-314	33	SF-13MM13	51	SF-19MM36	67
MB-3220	47	MF-76B	70	P-1414	26	SA-122-D	49	SA-510-19M	63	SC-314	49	SF-13MM15	62	SF-19MM43	51
MB-3314	47	MF-77B	73	P-1416	26	SA-123	49	SA-510-20M	63	SC-314	53	SF-13MM21	43	SF-19MM45	62
MB-3318	47	MF-82	73	P-2010	26	SA-123-D	49	SA-510-21M	63	SC-508	33	SF-13MM23	51	SF-19MM55	62
MB-3512	47	MF-82B	73	P-2012	26	SA-124	49	SA-510-22M	63	SC-514	24	SF-13MM25	62	SF-20MM15	62
MB-3514	47	MFL-1000	81	P-2014	26	SA-124-D	49	SA-510-24M	63	SC-514	25	SF-13MM25	76	SF-21MM15	62
MB-3516	47	MFL-250	81	P-2016	26	SA-125	49	SA-535	69	SC-514	33	SF-13MM33	51	SF-21MM16	67
MB-5,5MM21	43	MHA-510	41	P-320X	15	SA-125-D	49	SA-537	69	SC-514	59	SF-13MM35	62	SF-21MM25	62
MB-5212	56	MHC-3816	47	P-322X	15	SA-15-6M	44	SA-538	69	SC-514	64	SF-13MM43	51	SF-21MM35	62
MB-5214	56	MHM-10MM	33	P-328X	15	SA-15-7M	44	SA-57-13M	63	SC-520	24	SF-13MM45	62	SF-21MM36	67
MB-5216	56	MHM-1310	33	QR-108	33	SA-16-10M	44	SA-57-14M	63	SC-520	33	SF-13MM55	62	SF-21MM45	62
MB-5220	56	MHM-1912	33	QR-308	33	SA-16-8M	44	SA-58-15M	63	SC-520	59	SF-14MM13	51	SF-21MM55	62
MB-5MM21	43	MHM-7MM	33	QR-314	33	SA-200	49	SA-58-16M	63	SC-529	59	SF-14MM15	62	SF-22MM15	62
MB-6MM21	43	MHM-8MM	33	QR-508	33	SA-201	49	SA-58-17M	63	SC-614	33	SF-14MM25	62	SF-22MM16	67
MB-6MM23	51	MR-7MME1	44	QR-514	33	SA-202	49	SA-58-18M	63	SC-620	33	SF-14MM35	62	SF-22MM25	62
MB-7MM21	43	MSH-335	56	QR-520	33	SA-202-D	49	SA-601	69	SC-720	25	SF-14MM45	62	SF-22MM35	62
MB-7MM23	51	MSH-336	56	QR-614	33	SA-203	49	SA-603	69	SC-720	33	SF-14MM55	62	SF-22MM36	67
MB-8MM21	43	MSH-400	80	QR-620	33	SA-203-D	49	SA-604	69	SC-724	33	SF-15MM03	51	SF-22MM55	62
MB-8MM23	51	MSW-343	47	QR-714	33	SA-205	49	SA-606	69	SC-728	33	SF-15MM11	43	SF-23MM15	62
MB-9MM21	43	MSW-350	80	QR-720	33	SA-205-D	49	SA-607	69	SC-820	25	SF-15MM13	51	SF-24MM15	62
MB-9MM23	51	MSW-604	47	QR-820	33	SA-216	58	SA-609	69	SC-820	33	SF-15MM15	62	SF-24MM16	67
MB-HE9518	56	MSW-90	80	QR-824	33	SA-216-D	58	SA-610	69	SC-828	33	SF-15MM16	67	SF-24MM25	62
MDA-08	33	MSW-90-B	80	QRA-08	33	SA-217	58	SA-65	62	SD-1055-A	7	SF-15MM23	51	SF-24MM35	62
MDA-10	33	MSW-984	80	QRA-14	33	SA-217-D	58	SA-712	69	SD-1342-2	9	SF-15MM25	62	SF-24MM36	67
MDA-10MM	33	MSW-984-B	80	QRF-08	33	SA-218	58	SA-716	69	SD-1342-2-PZD	19	SF-15MM25	76	SF-3010	47
MDA-10MM-80M	33	MX-1108	41	QRF-147	33	SA-218-D	58	SA-C-120	49	SD-2052-10	8	SF-15MM33	51	SF-3012	47
MDA-12	33	MX-1109	41	QRF-20	33	SA-219	58	SA-C-122	49	SD-2052-8	8	SF-15MM35	62	SF-3014	47
MDA-14	33	MX-1110	41	QR-M-490-2	31	SA-219-D	58	SA-C-123	49	SD-4048	18	SF-15MM36	67	SF-3016	47
MDA-6MM	33	MX-1111	41	QR-M-490-200M	31	SA-221	58	SA-C-124	49	SD-4693	17	SF-15MM43	51	SF-3018	47
MDA-7MM	33	MX-1112	41	QR-M-490-A	31	SA-221-D	58	SA-C-205	49	SD-5187	80	SF-15MM45	62	SF-3110	47
MDA-8MM	33	MZA-110	81	QR-M-490-A6	31	SA-25	42	SA-C-216	58	SD-5197	80	SF-15MM55	62	SF-3112	47
MDAT-08	33	MZA-310	81	R-320X	15	SA-25-D	42	SA-C-217	58	SD-556	8	SF-16MM13	51	SF-3114	47
MDB-08	33	MZA-314	81	R-321X	15	SA-26	42	SA-C-218	58	SD-556-A	8	SF-16MM15	62	SF-3116	47
MDB-10	33	MZA-510	81	R-322X	15	SA-26-D	42	SA-C-219	58	SF-10MM03	51	SF-16MM16	67	SF-3118	47
MDB-12	33	MZA-514	81	R-328X	15	SA-28	42	SA-C-221	58	SF-10MM11	43	SF-16MM25	62	SF-3120	47
MDB-14	33	MZN-312	81	R-32-TX-27	17	SA-28-D	42	SA-C-305	49	SF-10MM13	51	SF-16MM35	62	SF-3212	48
MDC-08	33	MZN-314	81	RM-490	31	SA-29	42	SA-C-306	49	SF-10MM15	62	SF-16MM45	62	SF-3214	48
MDC-10	33	MZN-514	81	RM-490-4	31	SA-29-D	42	SA-C-321	58	SF-10MM21	43	SF-16MM55	62	SF-3216	48
MDC-12	33	NP-32-TX-25	17	RM-490-6	31	SA-30	42	SA-C-322	58	SF-10MM23	51	SF-17MM03	51	SF-3218	48
MET-1301C	82	OL-322X	15	RP-314	33	SA-302	49	SA-C-36-10M	52	SF-10MM25	62	SF-17MM13	51	SF-3224	48
MET-1302C	82	OOL-322X	15	RP-514	33	SA-305	49	SA-C-37-12M	52	SF-10MM33	51	SF-17MM15	62	SF-3234	48
MET-1401C	82	OOL-322X	15	RP-520	24	SA-306	49	SA-C-37-13M	52	SF-10MM35	62	SF-17MM16	67	SF-3316	48
MET-1402C	82	OS-10MM03	50	RP-520	25	SA-30-D	42	SA-C-37-14M	52	SF-10MM43	51	SF-17MM23	51	SF-3318	48
MET-1600C	82	OS-10MM11	43	RP-520	33	SA-31	58	SA-C-38-15M	52	SF-10MM45	62	SF-17MM25	62	SF-3320	48
MET-1800C	82	OS-10MM23	50	RP-520	64	SA-316	58	SA-C-38-17M	52	SF-10MM55	62	SF-17MM35	62	SF-3324	48
MF-25	45	OS-10MM23-D	50	RP-614	33	SA-318	58	SA-C-38-18M	52	SF-1112	41	SF-17MM43	51	SF-3412	47
MF-25-B	45	OS-3310-D	46	RP-620	33	SA-318-D	58	SA-C-407	58	SF-1116	41	SF-17MM45	62	SF-3414	47
MF-27	54	OS-3410	46	RP-720	25	SA-320	58	SA-C-409	58	SF-11MM13	51	SF-17MM55	62	SF-3416	47
MF-27-B	54	OS-5424	55	RP-720	33	SA-321	58	SA-C-410	58	SF-11MM15	62	SF-18MM13	51	SF-3418	47
MF-37	54	OS-5516	56	RP-724	33	SA-321-D	58	SA-C-411	58	SF-11MM23	51	SF-18MM15	62	SF-3432	47
MF-37-B	54	OS-5518	56	RP-728	25	SA-322	58	SA-C-508	58	SF-11MM25	62	SF-18MM16	67	SF-3512	48
MF-38-B	54	OS-8MM13	50	RP-728	33	SA-322-D	58	SA-C-510	58	SF-11MM43	51	SF-18MM23	51	SF-3514	48
MF-39	65	OSM-3410	47	RP-820	25	SA-402	58	SA-C-510-21M	63	SF-11MM45	62	SF-18MM25	62	SF-3516	48
MF-39B	65	OSM-3414	47	RP-820	33	SA-402-D	58	SA-C-510-22M	63	SF-11MM55	62	SF-18MM25	76	SF-3518	48
MF-50	65	OSMB-10MM21	43	RP-828	25	SA-404	58	SA-C-57-13M	63	SF-12MM03	51	SF-18MM35	62	SF-5112	56
MF-50B	65	OSMB-10MM23	51	RP-828	33	SA-404-D	58	SA-C-57-14M	63	SF-12MM13	51	SF-18MM36	67	SF-5116	56
MF-51	67	OSMB-8MM23	51	RP-848	25	SA-406	58	SA-C-58-15M	63	SF-12MM15	62	SF-18MM43	51	SF-5118	56
MF-55	65	OSSF-10MM23	51	S-320X	15	SA-407	58	SA-C-58-16M	63	SF-12MM21	43	SF-18MM45	62	SF-5120	56
MF-55B	65	OSSF-10MM43	51	S-321X	15	SA-409	58	SA-C-58-17M	63	SF-12MM23	51	SF-18MM55	62	SF-5122	56
MF-62	67	OSSF-3512	48	S-328X	15	SA-409-D	58	SA-C-58-18M	63	SF-12MM25	62	SF-19MM13	51	SF-5124	56

Part Number Index

Number	Page	Number	Page	Number	Page	Number	Page	Number	Page	Number	Page	Number	Page	Number	Page
SF-5126	56	SH-57-3	80	SZ-12	49	SZ-33-A	25	SZ-7-6MM	53	TWD-4-ACR	29	UG-855	76	ZE-514	81
SF-5128	56	SH-57-4	80	SZ-12-A	24	SZ-34	25	SZ-7-8MM	25	TWD-5	29	UG-EX-250-2	76	ZN-112	81
SF-5130	56	SH-57-6	80	SZ-12-A-2	24	SZ-34-A	25	SZ-7-8MM	25	TWD-5-ACR	29	UG-EX-250-4	76	ZN-114	81
SF-5132	56	SH-57-8	80	SZ-12-A-3	24	SZ-35	25	SZ-7-8MM	25	TWD-6	29	UG-EX-250-6	76	ZN-312	81
SF-5134	56	SH-59	80	SZ-12-A-6	24	SZ-35-A	25	SZ-7-8MM	64	TWD-7	29	UG-EX-370-2	76	ZN-314	81
SF-5212	57	SH-59-3	80	SZ-13	24	SZ-36	25	SZ-7-A	24	TWE-4	29	UG-EX-370-4	76	ZN-512	81
SF-5216	57	SH-59-4	80	SZ-13	49	SZ-36-A	25	SZ-80	25	TWE-5	29	UG-EX-370-6	76	ZN-514	81
SF-5218	57	SH-59-6	80	SZ-13-A	24	SZ-37	25	SZ-8-14-17MM	25	TX-1104	45	UG-EX-376-12	76		
SF-5222	57	SH-629	80	SZ-13-A-3	24	SZ-37-10MM	25	SZ-8-14-19MM	25	TX-1105	45	UG-EX-376-3	76		
SF-5224	57	SH-629-5	80	SZ-14	24	SZ-3-7-10MM	53	SZ-8-14-22MM	25	TX-1106	45	UG-EX-376-6	76		
SF-5226	57	SH-629-6	80	SZ-14	49	SZ-3-7-4MM	25	SZ-8-14-24MM	25	TX-1108	45	UG-EX-508-12	76		
SF-5228	57	SH-629-P	80	SZ-14-17MM	25	SZ-3-7-4MM	53	SZ-8-14-27MM	25	TX-1110	45	UG-EX-508-4	76		
SF-5230	57	SJ-241	83	SZ-14-19MM	25	SZ-3-7-5MM	25	SZ-85	25	TX-1112	45	UG-EX-508-8	76		
SF-5232	57	SJ-349	83	SZ-14-22MM	25	SZ-3-7-5MM	53	SZ-85-A	25	TX-1404	45	UG-M-10MM13	76		
SF-5318	57	SJ-350	83	SZ-14-24MM	25	SZ-3-7-6MM	25	SZ-86	25	TX-1405	45	UG-M-10MM21	76		
SF-5320	57	SJ-351	83	SZ-14-27MM	25	SZ-3-7-6MM	53	SZ-87	25	TX-1406	45	UG-M-10MM23	76		
SF-5324	57	SJ-352	83	SZ-14-A	24	SZ-3-7-8MM	25	SZ-88	25	TX-1407	45	UG-M-13MM23	76		
SF-5328	57	SJ-360	83	SZ-14-A	59	SZ-3-7-8MM	53	SZ-89	25	TX-1408	45	UG-M-490	76		
SF-5330	57	SJ-361	83	SZ-14-A-3	24	SZ-37-A	25	SZ-8L-TX-70	18	TX-1410	45	UG-M-490-4	76		
SF-5412	56	SJ-362	83	SZ-14-A-4	24	SZ-38	25	SZ-9	24	TX-1411	45	UG-M-490-6	76		
SF-5414	56	SJ-364	83	SZ-15	24	SZ-38-A	25	SZ-91	25	TX-1412	45	UG-M-825	76		
SF-5416	56	SJ-375	83	SZ-15	49	SZ-41	24	SZ-9-A	24	TX-1E05	45	UG-M-835	76		
SF-5418	56	SJ-379	83	SZ-15-A	24	SZ-42	24	SZ-TX-100	18	TX-1E06	45	UG-M-838	76		
SF-5420	56	SJ-380	83	SZ-15-A	59	SZ-42	59	SZ-TX-100-A	16	TX-1E08	45	UG-M-855	76		
SF-5422	56	SJ-55	83	SZ-15-A-2	24	SZ-43	24	SZ-TX-55-A	16	TX-3106	53	UG-M-858	76		
SF-5424	56	SJ-66	83	SZ-15-A-3	24	SZ-43	59	SZ-TX-60-A	16	TX-3107	53	UG-MB-10MM21	76		
SF-5426	56	SJ-67	83	SZ-15-A-4	24	SZ-44	24	SZ-TX-70-A	16	TX-3108	53	UG-MB-10MM23	76		
SF-5514	57	SJ-68	83	SZ-16	24	SZ-44	59	SZ-TX-70-A-3	16	TX-3110	53	UG-MB-13MM23	76		
SF-5516	57	SJ-935-1/2	80	SZ-16	49	SZ-5-10-14MM	25	SZ-TX-80-A	16	TX-3112	53	UG-SF-13MM25	76		
SF-5518	57	SJ-935-1/4	80	SZ-16-A	24	SZ-5-10-14MM	64	SZ-TX-90-A	16	TX-3114	53	UG-SF-15MM25	76		
SF-5520	57	SJ-935-10MMX6	80	SZ-16-A	59	SZ-5-10-17MM	25	T-320X	15	TX-3116	53	UG-SF-18MM25	76		
SF-5524	57	SJ-935-12MMX8	80	SZ-16-A-3	24	SZ-5-10-17MM	64	T-321X	15	TX-3406	53	W-321X	15		
SF-5526	57	SJ-935-14MMX10	80	SZ-16-A-4	24	SZ-5-10-19MM	25	TH-250	36	TX-3407	53	WJ-265-1/2	81		
SF-5528	57	SJ-935-17MMX12	80	SZ-17	24	SZ-5-7-10MM	25	TH-256	36	TX-3408	53	WJ-265-1/4	81		
SF-5532	57	SJ-935-17MMX8	80	SZ-17-A	24	SZ-5-7-10MM	64	TH-257	82	TX-3410	53	WJ-265-13/64	81		
SF-6118	66	SJ-935-3/8	80	SZ-17-A	59	SZ-5-7-12MM	25	TH-370	36	TX-3412	53	WJ-265-17/32	81		
SF-6120	66	SJ-935-5/16	80	SZ-18	24	SZ-5-7-12MM	64	TH-372	36	TX-3414	53	WJ-265-3/16	81		
SF-6124	66	SJ-935-7/16	80	SZ-18-A	24	SZ-5-7-14MM	25	TH-376	36	TX-3508	53	WJ-265-3/8	81		
SF-6128	66	SW-282	55	SZ-18-A	59	SZ-5-7-14MM	64	TH-377	82	TX-3E08	53	WJ-265-7/16	81		
SF-6320	66	SW-282-D	55	SZ-19	24	SZ-5-7-4MM	25	TH-378	82	TX-3E10	53	WJ-284-1/4	81		
SF-6324	66	SW-343	46	SZ-19-A	24	SZ-5-7-5MM	25	TH-501	82	TX-5110	64	WJ-284-1/8	81		
SF-6326	66	SW-350	80	SZ-19-A	59	SZ-5-7-6MM	25	TH-502	82	TX-5112	64	WJ-284-3/16	81		
SF-6328	66	SW-493	55	SZ-20	24	SZ-5-7-8MM	25	TM-20	82	TX-5114	64	WJ-284-3/8	81		
SF-6330	66	SW-604	46	SZ-21	24	SZ-5-7-8MM	64	TM-24	82	TX-5116	64	WJ-284-5/16	81		
SF-6424	66	SW-605	46	SZ-22	24	SZ-7	24	TN-20	82	TX-5118	64	WJ-284-5/32	81		
SF-6524	66	SW-605-D	46	SZ-22	59	SZ-7-10-10MM	25	TN-24	82	TX-5120	64	WJ-284-7/64	81		
SF-8MM11	43	SZ-10	24	SZ-23	24	SZ-7-10-12MM	25	TW-0	29	TX-5124	64	WJ-284-9/64	81		
SF-8MM13	51	SZ-10	49	SZ-23	59	SZ-7-10-14MM	25	TW-1	29	TX-5408	64	X-1108	41		
SF-8MM23	51	SZ-101	25	SZ-24	24	SZ-7-10-17MM	25	TW-2	29	TX-5410	64	X-1110	41		
SF-HC-3816	47	SZ-10-10MM	25	SZ-24	59	SZ-7-10MM	25	TW-3	29	TX-5412	64	Y-321X	15		
SF-HE-9518	57	SZ-10-12MM	25	SZ-25	24	SZ-7-10MM	25	TW-4	29	TX-5414	64	YK-250	82		
SF-SH-335	56	SZ-10-14MM	25	SZ-25	59	SZ-7-10MM	53	TW-5	29	TX-5416	64	YK-252	82		
SF-SH-336	56	SZ-10-14MM	25	SZ-26	24	SZ-7-10MM	64	TW-6	29	TX-5418	64	YK-37	82		
SF-SW-282	56	SZ-10-14MM	64	SZ-26	59	SZ-7-12MM	25	TW-7	29	TX-5420	64	YK-370	82		
SH-335	55	SZ-10-17MM	25	SZ-27	24	SZ-7-12MM	64	TWA-6	29	U-321X	15	YK-500	82		
SH-336	55	SZ-10-17MM	25	SZ-30	25	SZ-7-14MM	25	TWA-7	29	UG-10MM13	76	YK-501	82		
SH-336-D	55	SZ-10-17MM	64	SZ-30-A	25	SZ-7-14MM	64	TWA-8	29	UG-10MM21	76	YK-502	82		
SH-338	55	SZ-10-19MM	25	SZ-31	25	SZ-7-4MM	25	TWB-6	29	UG-10MM23	76	ZA-110	81		
SH-338-D	55	SZ-101-A	25	SZ-31-A	25	SZ-7-4MM	25	TWB-7	29	UG-13MM23	76	ZA-310	81		
SH-339	55	SZ-10-A	24	SZ-32	25	SZ-7-4MM	53	TWB-8	29	UG-13MM25	76	ZA-314	81		
SH-402	80	SZ-11	24	SZ-32-A	24	SZ-7-5MM	25	TWD-0	29	UG-15MM25	76	ZA-510	81		
SH-404	80	SZ-11	49	SZ-32-A	25	SZ-7-5MM	25	TWD-1	29	UG-18MM25	76	ZA-512	81		
SH-412	80	SZ-11-A	24	SZ-32-A	59	SZ-7-5MM	53	TWD-2	29	UG-825	76	ZA-514	81		
SH-414	80	SZ-11-A-3	24	SZ-33	25	SZ-7-6MM	25	TWD-3	29	UG-835	76	ZE-112	81		
SH-57	80	SZ-12	24	SZ-33-A	24	SZ-7-6MM	25	TWD-4	29	UG-838	76	ZE-314	81		

Conversion Tables

Millimeter – Decimal – Fraction

mm	Dec.	in.	mm	Dec.	in.	mm	Dec.	in.	mm	Dec.	in.	mm	Dec.	in.
0.100	.0039		5.159	.2031	13/64	10.200	.4016		15.300	.6024		20.300	.7992	
0.200	.0079		5.200	.2047		10.300	.4055		15.400	.6063		20.400	.8031	
0.300	.0118		5.300	.2087		10.319	.4063	13/32	15.478	.6094	39/64	20.500	.8071	
0.397	.0156	1/64	5.400	.2126		10.400	.4094		15.500	.6102		20.600	.8110	
0.400	.0157		5.500	.2165		10.500	.4134		15.600	.6142		20.638	.8125	13/16
0.500	.0197		5.556	.2188	7/32	10.600	.4173		15.700	.6181		20.700	.8150	
0.600	.0236		5.600	.2205		10.700	.4219		15.800	.6220		20.800	.8189	
0.700	.0276		5.700	.2244		10.716	.4219	27/64	15.875	.6250	5/8	20.900	.8228	
0.794	.0313	1/32	5.800	.2283		10.800	.4252		15.900	.6250		21.000	.8268	
0.800	.0315		5.900	.2323		10.900	.4291		16.000	.6299		21.034	.8182	53/64
0.900	.0354		5.953	.2344	15/64	11.000	.4331		16.100	.6339		21.100	.8307	
1.000	.0394		6.000	.2362		11.100	.4370		16.200	.6378		21.200	.8307	
1.100	.0433		6.100	.2402		11.113	.4375	7/16	16.272	.6406	41/64	21.200	.8346	
1.191	.0469	3/64	6.200	.2441		11.200	.4409		16.300	.6417		21.300	.8386	
1.200	.0472		6.300	.2480		11.300	.4449		16.400	.6457		21.400	.8425	
1.300	.0512		6.350	.2500	1/4	11.400	.4488		16.500	.6496		21.431	.8438	27/32
1.400	.0551		6.400	.2520		11.500	.4528		16.600	.6535		21.500	.8465	
1.500	.0591		6.500	.2559		11.509	.4531	29/64	16.669	.6563	21/32	21.600	.8504	
1.588	.0625	1/16	6.600	.2598		11.600	.4567		16.700	.6575		21.700	.8543	
1.600	.0630		6.700	.2638		11.700	.4606		16.800	.6614		21.800	.8583	
1.700	.0669		6.747	.2656	17/64	11.800	.4646		16.900	.6654		21.828	.8594	55/94
1.800	.0709		6.800	.2677		11.900	.4685		17.000	.6693		21.900	.8622	
1.900	.0748		6.900	.2717		11.906	.4688	15/32	17.066	.6719	43/64	22.000	.8661	
1.984	.0781	5/64	7.000	.2756		12.000	.4724		17.100	.6732		22.100	.8701	
2.000	.0878		7.100	.2795		12.100	.4764		17.200	.6772		22.200	.8740	
2.100	.0827		7.144	.2813	9/32	12.200	.4803		17.300	.6811		22.225	.8750	7/8
2.200	.0866		7.200	.2835		12.300	.4843		17.400	.6850		22.300	.8780	
2.300	.0906		7.300	.2874		12.303	.4844	31/64	17.463	.6875	11/16	22.400	.8819	
2.381	.0938	3/32	7.400	.2913		12.400	.4882		17.500	.6890		22.500	.8858	
2.400	.0945		7.500	.2953		12.500	.4921		17.600	.6929		22.600	.8898	
2.500	.0984		7.541	.2969	19/64	12.600	.4961		17.700	.6968		22.622	.8906	57/64
2.600	.1024		7.600	.2992		12.700	.5000	1/2	17.800	.7008		22.700	.8937	
2.700	.1063		7.700	.3031		12.800	.5039		17.859	.7031	45/64	22.800	.8976	
2.778	.1094	7/64	7.800	.3071		12.900	.5079		17.900	.7047		22.900	.9016	
2.800	.1102		7.900	.3110		13.000	.5118		18.000	.7087		23.000	.9055	
2.900	.1142		7.938	.3125	5/16	13.097	.5156	33/64	18.100	.7126		23.019	.9063	29/32
3.000	.1181		8.000	.3150		13.100	.5157		18.200	.7165		23.100	.9094	
3.100	.1220		8.100	.3189		13.200	.5197		18.256	.7188	23/32	23.200	.9134	
3.175	.1250	1/8	8.200	.3228		13.300	.5236		18.300	.7205		23.300	.9173	
3.200	.1260		8.300	.3268		13.400	.5276		18.400	.7244		23.400	.9213	
3.300	.1299		8.334	.3281	21/64	13.494	.5313	17/32	18.500	.7283		23.416	.9219	59/64
3.400	.1339		8.400	.3307		13.500	.5315		18.600	.7323		23.500	.9252	
3.500	.1378		8.500	.3346		13.600	.5354		18.653	.7344	47/64	23.600	.9291	
3.572	.1406	9/64	8.600	.3386		13.700	.5394		18.700	.7362		23.700	.9331	
3.600	.1417		8.700	.3425		13.800	.5433		18.800	.7402		23.800	.9370	
3.700	.1457		8.731	.3438	11/32	13.891	.5469	35/64	18.900	.7441		23.900	.9409	
3.800	.1496		8.800	.3465		13.900	.5472		19.000	.7480		24.000	.9449	
3.900	.1535		8.900	.3504		14.000	.5512		19.050	.7500	3/4	24.100	.9488	
3.969	.1563	5/32	9.000	.3543		14.100	.5551		19.100	.7520		24.200	.9528	
4.000	.1575		9.100	.3583		14.200	.5591		19.200	.7559		24.209	.9531	61/64
4.100	.1624		9.128	.3594	23/64	14.288	.5625	9/16	19.300	.7598		24.300	.9567	
4.200	.1654		9.200	.3622		14.300	.5630		19.400	.7638		24.400	.9606	
4.300	.1693		9.300	.3661		14.400	.5669		19.447	.7656	49/64	24.500	.9646	
4.366	.1719	11/64	9.400	.3701		14.500	.5709		19.500	.7677		24.600	.9685	
4.400	.732		9.500	.3740		14.600	.5748		19.600	.7717		24.606	.9688	31/32
4.500	.1772		9.525	.3750	3/8	14.684	.5781	37/64	19.700	.7756		24.700	.9724	
4.600	.1811		9.600	.3780		14.700	.5787		19.800	.7795		24.800	.9764	
4.700	.1850		9.700	.3819		14.800	.5827		19.844	.7813	25/32	24.900	.9803	
4.763	.1875	3/16	9.800	.3858		14.900	.5866		19.900	.7835		25.000	.9843	
4.800	.1890		9.900	.3898		15.000	.5906		20.000	.7874		25.003	.9844	63/64
4.900	.1929		9.922	.3902	25/64	15.081	.5938	19/32	20.100	.7913		25.100	.9882	
5.000	.1969		10.000	.3937		15.100	.5945		20.200	.7953		25.200	.9921	
5.100	.2008		10.100	.3976		15.200	.5984		20.241	.7969	51/64	25.300	.9961	
												25.400	1.000	1

Powerful Brands

Apex Tool Group offers with the Power Tools product range a complete line of quality industrial tools and accessories – some of the most powerful and highly respected brands in the industry.

EUROPE EMEA

HOME ABOUT US BRANDS PRODUCTS DOWNLOADS SERVICE / AFTER MARKET NEWS CONTACT

Your Search: Searchword GO

Latest News

New Catalogue for Industrial Power Tools available
Industrial Power Tools for Professionals

Cleco Manuals LiveWire Pistol Battery Tools in more than 10 languages
Now the manuals for the Cleco LiveWire Pistol Battery Tools are available in more than 10...

Cleco Manuals LiveWire Angle Battery Tools in more than 10 languages
Now the manuals for the Cleco LiveWire Angle Battery Tools are available in more than 10 languages...

Cleco i-Wrench brochures now available in more than 10 languages
The brochures for the new Cleco torque wrenches are now available in more than 10

Apex Tool Group offers with the Power Tools product range a complete line of quality industrial tools and accessories – some of the most powerful and highly respected brands in the industry

Solutions That Drive World Industry
Automotive • Aerospace • Energy • General Industry

Airetool APEX Cleco DGD DOTCO GETA
Master Power Quaschimbush Recoules

Industrial Power Tools for Professionals

Cleco LiveWire i-Wrench for Production - Intelligent Torque Wrench

Our Cleco LiveWire i-Wrench is a true all around production tool to meet your flexible manufacturing needs. It is the perfect tool for advanced threaded tightenings. Read complete News...

Brochures: Cleco 19 series pneumatic tool generation

The new Cleco 19 series tools increase your productivity and offer you uncompromised comfort. We improved the reliable Clecomatic Clutch, you get higher precision, durability and repeatability. Brochures available!

Product video: Cleco 19 series pneumatic tool generation

The new Cleco 19 series tools increase your productivity and offer you uncompromised comfort. We improved the reliable Clecomatic Clutch, you get higher precision, durability and repeatability. See the latest product video!

Latest information online available

Manuals, technical drawings, 3D models, assembly instructions, product images as well as homologations are online available on our website.

EUROPE EMEA

HOME ABOUT US BRANDS PRODUCTS DOWNLOADS SERVICE / AFTER MARKET NEWS CONTACT

Apex Tool Group - Power Tools - Home | Downloads | Catalogs/Brochures

Your Login: Username GO

DOWNLOADS

Catalogs/Brochures

Brand Catalogs/Brochures Filetype

Request Form
Print
Recommend Page
Newsletter Signup

Material Safety Data Sheets
Catalogs/Brochures
Service Literature
Technical Drawings
Homologated Tools
Press Information
Certificates
Product Pictures
Product Videos

Displaying results 1 to 20 from 35

Airetool

GI-1250 - Industrial Power Tools for Professionals
Power Tools Main Catalog for Industrial Power Tools. Includes the most Important Power Tools from the Brands: Airetool, Apex, Dotco, Master Power, Cleco
Brand: Airetool
Category: Catalogs/Brochures
Filetype: PDF
Download: German (13.0 MByte)

26.09.2013

SP-1100 - Airetool - Tube Cleaners and Expanders...
Main Catalogue - Airetool - Tube Cleaners and Expanders SP1100/SP-1100
Brand: Airetool
Category: Catalogs/Brochures
Filetype: PDF
Download: English UK (5.4 MByte)

11.04.2013

Social Network Channels: Facebook, Twitter, YouTube, LinkedIn, Google+

RSS-Newsfeed: RSS, iRSS, AT20





Tube Cleaners & Expander

Catalogue: SP-1100



Industrial Power Tools for Professionals

Catalogue: GI-1250

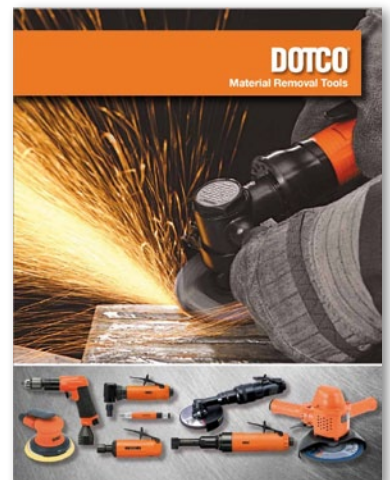

Dotco, Cleco Material Removal Tools

Catalogue: SP-102

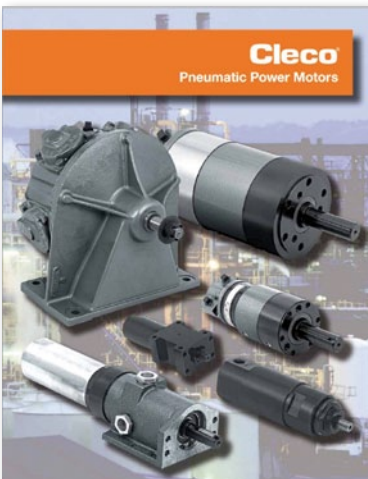

Cleco Industrial Pneumatic Power Motors

Catalogue: SP-104

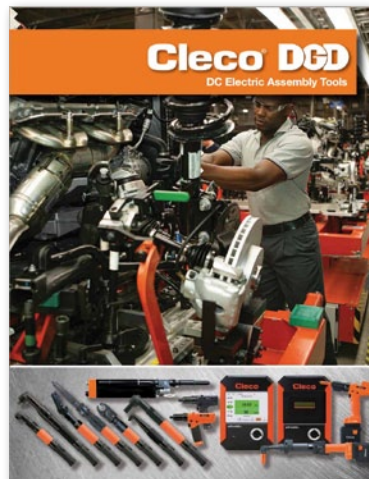

Cleco, DGD, industrial Electric Assembly Tools and Systems

Catalogue: SP-1020



Cleco Pneumatic Assembly Tools

Catalogue: SP-1000



Master Power, Pneumatic Material Removal and Assembly Tools

Catalogue: SP-904



Service and After Market Solutions

www.apexpowertools.eu



Sales and Service Centres

GERMANY

Apex Tool Group GmbH

Industriestrasse 1
73463 Westhausen
Germany

Tel.: +49 73 63 81 0

Fax: +49 73 63 81 222

E-mail: info@apexpowertools.eu

ENGLAND

Apex Tool Group GmbH

C/O Spline Gauges
Piccadilly, Tamworth,
Staffordshire B78 2ER
United Kingdom

Tel.: +44 1827 8741 28

Fax: +44 1827 8741 28

FRANCE

Apex Tool Group SAS

25 rue Maurice Chevalier
B. P. 28
77831 Ozoir-la-Ferrière Cedex
France

Tel.: +33 1 64 43 22 00

Fax: +33 1 64 43 17 17

HUNGARY

Apex Tool Group Hungaria Kft.

Platánfa u. 2
9027 Győr
Hungary

Tel.: +36 96 66 1383

Fax: +36 96 66 1135

ITALY

Apex Tool S.r.l.

Viale Europa No. 80
20090 CUSAGO

Italy

Tel.: +39 2903 3102 14

Fax: +39 2903 9423 1

You will find local dealers and other sales contacts at
www.apexpowertools.eu



The screenshot shows the Apex Tool Group website's 'CONTACT' page. At the top, there is a navigation menu with links for HOME, ABOUT US, BRANDS, PRODUCTS, DOWNLOADS, SERVICE / AFTER MARKET, NEWS, and CONTACT. Below the navigation is a search bar with the text 'Your Search:' and a 'GO' button. To the right of the search bar is a 'Your Login:' section with a 'Username' field and a 'GO' button. The main content area is titled 'CONTACT' and has a sub-section 'Power Tools: Sales'. Below this, there is a 'Distribution Partner Search' section with the instruction 'Please start typing the country name of the desired distribution partner:' and a search input field. To the left of the search field is a list of countries: Germany, France, United Kingdom, Turkey, Austria, Belarus, and More... Below the list are links for Service, Employment, Contact Form, and Approach. To the right of the search field is a world map with several regions highlighted in orange. On the far right, there are links for 'Request Form', 'Print', 'Recommend Page', and 'Newsletter Signup'. Below these are 'Social Network Channels' with icons for Facebook, Twitter, YouTube, LinkedIn, and Google+. At the bottom right, there are 'RSS-Newsfeed' icons for EMEA, USA, and ASIA.

RSS News Feeds



Stay in touch with us via social media.



Apex Tool Group GmbH

Industriestraße 1
73463 Westhausen
Germany

Tel: +49 73 63 81 0

Fax: +49 73 63 81 222

E-mail: info@apexpowertools.eu

Website: www.apexpowertools.eu



APEX
TOOL GROUP